

THE GRID CODE

Issue 3

Revision 12
30th September 2005

Copyright © NATIONAL GRID ELECTRICITY TRANSMISSION plc

No part of this publication may be reproduced, stored in a retrieval system or transmitted in any form or by any means electronic, mechanical, photocopying, recording or otherwise, without written permission.

THIS DOCUMENT IS ISSUED BY:-

**NATIONAL GRID ELECTRICITY TRANSMISSION Ltd
COMMERCIAL, ELECTRICITY CODES
NATIONAL GRID HOUSE
WARWICK TECHNOLOGY PARK
GALLOWS HILL
WARWICK
CV34 6DA**

**REGISTERED OFFICE: 1-3 Strand
London
WC2N 5EH**

THE GRID CODE

CONTENTS

(PREFACE	which does not form	(PF))
(part of the Grid Code)
GLOSSARY AND DEFINITIONS		(GD)
PLANNING CODE		(PC)
CONNECTION CONDITIONS		(CC)
OPERATING CODES		(OC)
OC1	Demand Forecasts	
OC2	Operational Planning and Data Provision	
OC3	Deleted	
OC4	Deleted	
OC5	Testing and Monitoring	
OC6	Demand Control	
OC7	Operational Liaison	
OC8	Safety Co-ordination	
OC9	Contingency Planning	
OC10	Event Information Supply	
OC11	Numbering and Nomenclature of HV Apparatus at Certain Sites	
OC12	System Tests	
BALANCING CODES		(BC)
BC1	Pre Gate Closure Process	
BC2	Post Gate Closure Process	
BC3	Frequency Control Process	
DATA REGISTRATION CODE		(DRC)
GENERAL CONDITIONS		(GC)
(REVISIONS	which does not form	(R))
(part of the Grid Code)

PREFACE

1. The operating procedures and principles governing **NGET's** relationship with all **Users** of the **GB Transmission System**, be they **Generators**, **DC Converter** owners, **Suppliers** or **Non-Embedded Customers** are set out in the **Grid Code**. The **Grid Code** specifies day-to-day procedures for both planning and operational purposes and covers both normal and exceptional circumstances.
2. The **Grid Code** is designed to permit the development, maintenance and operation of an efficient, co-ordinated and economical **GB Transmission System**, to facilitate competition in the generation and supply of electricity and is conceived as a statement of what is optimal (particularly from a technical point of view) for all **Users** and **NGET** itself in relation to the planning, operation and use of the **GB Transmission System**. It seeks to avoid any undue discrimination between **Users** and categories of **Users**.
3. The **Grid Code** is divided into the following sections:-
 - (a) a **Planning Code** which provides generally for the supply of certain information by **Users** in order for **NGET** to undertake the planning and development of the **GB Transmission System**;
 - (b) **Connection Conditions**, which specify the minimum technical, design and operational criteria which must be complied with by **NGET** at **Connection Sites** and by **Users** connected to or seeking connection with the **GB Transmission System** or by **Generators** (other than in respect of **Small Power Stations**) or **DC Converter** owners, connected to or seeking connection to a **User's System**;
 - (c) an **Operating Code**, which is split into a number of sections and deals with **Demand** forecasting (**OC1**); the co-ordination of the outage planning process in respect of **Large Power Stations**, the **GB Transmission System** and **User Systems** for construction, repair and maintenance, and the provision of certain types of **Operating Margin** data (**OC2**); testing and monitoring of **Users** (**OC5**); different forms of reducing **Demand** (**OC6**); the reporting of scheduled and planned actions, and unexpected occurrences such as faults (**OC7**); the co-ordination, establishment and maintenance of **Isolation** and **Earthing** in order that work and/or testing can be carried out safely (**OC8**); certain aspects of contingency planning (**OC9**); the provision of written reports on occurrences such as faults in certain circumstances (**OC10**); the procedures for numbering and nomenclature of **HV Apparatus** at certain sites (**OC11**); and the procedures for the establishment of **System Tests** (**OC12**);
 - (d) a **Balancing Code**, which is split into three sections and deals with the submission of **BM Unit Data** from **BM Participants**, and of certain other information, for the following day and ahead of **Gate Closure** (**BC1**); the post **Gate Closure** process (**BC2**); and the procedures and requirements in relation to **System Frequency** control (**BC3**);

- (e) a **Data Registration Code**, which sets out a unified listing of all data required by **NGET** from **Users**, and by **Users** from **NGET**, under the **Grid Code**;
 - (f) **General Conditions**, which are intended to ensure, so far as possible, that the various sections of the **Grid Code** work together and work in practice and include provisions relating to the establishment of a **Grid Code Review Panel** and other provisions of a general nature.
4. This **Preface** is provided to **Users** and to prospective **Users** for information only and does not constitute part of the **Grid Code**.

GLOSSARY AND DEFINITIONS (G & D)

1. In the **Grid Code** the following words and expressions shall, unless the subject matter or context otherwise requires or is inconsistent therewith, bear the following meanings:

Act The Electricity Act 1989 (as amended by the Utilities Act 2000 and the Energy Act 2004)

Active Energy The electrical energy produced, flowing or supplied by an electric circuit during a time interval, being the integral with respect to time of the instantaneous power, measured in units of watt-hours or standard multiples thereof, ie:

1000 Wh = 1 kWh
1000 kWh = 1 MWh
1000 MWh = 1 GWh
1000 GWh = 1 TWh.

Active Power The product of voltage and the in-phase component of alternating current measured in units of watts and standard multiples thereof, ie:

1000 Watts = 1 kW
1000 kW = 1 MW
1000 MW = 1 GW
1000 GW = 1 TW.

Affiliate In relation to any person, any holding company or subsidiary of such person or any subsidiary of a holding company of such person, in each case within the meaning of Section 736, 736A and 736B of the Companies Act 1985 as substituted by section 144 of the Companies Act 1989 and, if that latter section is not in force at the **Transfer Date**, as if such section were in force at such date.

Ancillary Service A **System Ancillary Service** and/or a **Commercial Ancillary Service**, as the case may be.

Ancillary Services Agreement An agreement between a **User** and **NGET** for the payment by **NGET** to that **User** in respect of the provision by such **User** of **Ancillary Services**.

Annual Average Cold Spell Conditions or ACS Conditions A particular combination of weather elements which gives rise to a level of peak **Demand** within a **Financial Year** which has a 50% chance of being exceeded as a result of weather variation alone.

<u>Apparent Power</u>	The product of voltage and of alternating current measured in units of voltamperes and standard multiples thereof, ie: 1000 VA = 1 kVA 1000 kVA = 1 MVA.
<u>Apparatus</u>	Other than in OC8 , means all equipment in which electrical conductors are used, supported or of which they may form a part. In OC8 it means High Voltage electrical circuits forming part of a System on which Safety Precautions may be applied to allow work and/or testing to be carried out on a System .
<u>Authorised Electricity Operator</u>	Any person (other than NGET in its capacity as operator of the GB Transmission System) who is authorised under the Act to generate, participate in the transmission of, distribute or supply electricity.
<u>Automatic Voltage Regulator or AVR</u>	A continuously acting automatic excitation system to control a Generating Unit terminal voltage.
<u>Authority for Access</u>	An authority which grants the holder the right to unaccompanied access to sites containing exposed HV conductors.
<u>Authority, The</u>	The Authority established by section 1 (1) of the Utilities Act 2000
<u>Auxiliaries</u>	Any item of Plant and/or Apparatus not directly a part of the boiler plant or Generating Unit or DC Converter or Power Park Module , but required for the boiler plant's or Generating Unit's or DC Converter's or Power Park Module's functional operation.
<u>Auxiliary Diesel Engine</u>	A diesel engine driving a Generating Unit which can supply a Unit Board or Station Board , which can start without an electrical power supply from outside the Power Station within which it is situated.
<u>Auxiliary Gas Turbine</u>	A Gas Turbine Unit , which can supply a Unit Board or Station Board , which can start without an electrical power supply from outside the Power Station within which it is situated.
<u>Average Conditions</u>	That combination of weather elements within a period of time which is the average of the observed values of those weather elements during equivalent periods over many years (sometimes referred to as normal weather).
<u>Back-Up Protection</u>	Protection equipment or system which is intended to operate when a system fault is not cleared in due time because of failure or inability of the Main Protection to operate or in case of failure to operate of a circuit-breaker other than the associated circuit breaker.

<u>Balancing and Settlement Code or BSC</u>	The code of that title as from time to time amended.
<u>Balancing Code or BC</u>	That portion of the Grid Code which specifies the Balancing Mechanism process.
<u>Balancing Mechanism</u>	Has the meaning set out in NGET's Transmission Licence
<u>Balancing Mechanism Reporting Agent or BMRA</u>	Has the meaning set out in the BSC .
<u>Balancing Mechanism Reporting Service or BMRS</u>	Has the meaning set out in the BSC .
<u>Balancing Principles Statement</u>	A statement prepared by NGET in accordance with Condition C16 of NGET's Transmission Licence .
<u>Bid-Offer Acceptance</u>	<ul style="list-style-type: none"> a) A communication issued by NGET in accordance with BC2.7; or b) an Emergency Instruction to the extent provided for in BC2.9.2.3.
<u>Bid-Offer Data</u>	Has the meaning set out in the BSC .
<u>Bilateral Agreement</u>	Has the meaning set out in the CUSC
<u>Black Start</u>	The procedure necessary for a recovery from a Total Shutdown or Partial Shutdown .
<u>Black Start Capability</u>	An ability in respect of a Black Start Station , for at least one of its Gensets to Start-Up from Shutdown and to energise a part of the System and be Synchronised to the System upon instruction from NGET , within two hours, without an external electrical power supply.
<u>Black Start Stations</u>	Power Stations which are registered, pursuant to the Bilateral Agreement with a User , as having a Black Start Capability .
<u>Black Start Test</u>	A Black Start Test carried out by a Generator with a Black Start Station , on the instructions of NGET , in order to demonstrate that a Black Start Station has a Black Start Capability .

<u>BM Participant</u>	A person who is responsible for and controls one or more BM Units or where a Bilateral Agreement specifies that a User is required to be treated as a BM Participant for the purposes of the Grid Code . For the avoidance of doubt, it does not imply that they must be active in the Balancing Mechanism .
<u>BM Unit</u>	Has the meaning set out in the BSC , except that for the purposes of the Grid Code the reference to “Party” in the BSC shall be a reference to User .
<u>BM Unit Data</u>	The collection of parameters associated with each BM Unit , as described in Appendix 1 of BC1 .
<u>Boiler Time Constant</u>	Determined at Registered Capacity , the boiler time constant will be construed in accordance with the principles of the IEEE Committee Report "Dynamic Models for Steam and Hydro Turbines in Power System Studies" published in 1973 which apply to such phrase.
<u>British Standards or BS</u>	Those standards and specifications approved by the British Standards Institution.
<u>BSCCo</u>	Has the meaning set out in the BSC .
<u>BSC Panel</u>	Has meaning set out for “Panel” in the BSC .
<u>BS Station Test</u>	A Black Start Test carried out by a Generator with a Black Start Station while the Black Start Station is disconnected from all external alternating current electrical supplies.
<u>BS Unit Test</u>	A Black Start Test carried out on a Generating Unit or a CCGT Unit , as the case may be, at a Black Start Station while the Black Start Station remains connected to an external alternating current electrical supply.
<u>Business Day</u>	Any week day (other than a Saturday) on which banks are open for domestic business in the City of London.
<u>Cancellation of GB Transmission System Warning</u>	The notification given to Users when a GB Transmission System Warning is cancelled.

Cascade Hydro Scheme

Two or more hydro-electric **Generating Units**, owned or controlled by the same **Generator**, which are located in the same water catchment area and are at different ordnance datums and which depend upon a common source of water for their operation, known as:

1. Moriston
2. Killin
3. Garry
4. Conon
5. Clunie
6. Beaully

which will comprise more than one **Power Station**.

Cascade Hydro Scheme Matrix

The matrix described in Appendix 1 to **BC1** under the heading **Cascade Hydro Scheme Matrix**.

Caution Notice

A notice conveying a warning against interference.

Category 1 Intertripping Scheme

A **System to Generator Operational Intertripping Scheme** arising from a Variation to Connection Design following a request from the relevant **User** which is consistent with the criteria specified in the **Security and Quality of Supply Standard**.

Category 2 Intertripping Scheme

A **System to Generator Operational Intertripping Scheme** which is:-
(i) required to alleviate an overload on a circuit which connects the **Group** containing the **User's Connection Site** to the **GB Transmission System**; and
(ii) installed in accordance with the requirements of the planning criteria of the **Security and Quality of Supply Standard** in order that measures can be taken to permit maintenance access for each transmission circuit and for such measures to be economically justified,
and the operation of which results in a reduction in **Active Power** on the overloaded circuits which connect the **User's Connection Site** to the rest of the **GB Transmission System** which is equal to the reduction in **Active Power** from the **Connection Site** (once any system losses or third party system effects are discounted).

Category 3 Intertripping Scheme

A **System to Generator Operational Intertripping Scheme** which, where agreed by **NGET** and the **User**, is installed to alleviate an overload on, and as an alternative to, the reinforcement of a third party system, such as the **Distribution System** of a **Public Distribution System Operator**.

Category 4 Intertripping Scheme

A **System to Generator Operational Intertripping Scheme** installed to enable the disconnection of the **Connection Site** from the **GB Transmission System** in a controlled and efficient manner in order to facilitate the timely restoration of the **GB Transmission System**.

CENELEC

European Committee for Electrotechnical Standardisation.

CCGT Module Matrix

The matrix described in Appendix 1 to BC1 under the heading **CCGT Module Matrix**.

CCGT Module Planning Matrix

A matrix in the form set out in Appendix 3 of OC2 showing the combination of **CCGT Units** within a **CCGT Module** which would be running in relation to any given MW output.

Cluster

1. Before Telemetry

A cluster of wind turbines will be formed when the total wind capacity within any circle of five kilometre radius has a **Registered Capacity** of not less than 5MW

2. After Telemetry

Any wind turbine installed within a five kilometer radius of the anemometer position (whether installed before or after the installation of that anemometer) will be deemed to be within the cluster for that anemometer and will not count towards the creation of any new cluster. All other wind turbines may count towards the creation of further clusters.

Combined Cycle Gas Turbine Module or CCGT Module

A collection of **Generating Units** (registered as a **CCGT Module** under the PC) comprising one or more **Gas Turbine Units** (or other gas based engine units) and one or more **Steam Units** where, in normal operation, the waste heat from the **Gas Turbines** is passed to the water/steam system of the associated **Steam Unit** or **Steam Units** and where the component units within the **CCGT Module** are directly connected by steam or hot gas lines which enable those units to contribute to the efficiency of the combined cycle operation of the **CCGT Module**.

Combined Cycle Gas Turbine Unit or CCGT Unit

A **Generating Unit** within a **CCGT Module**.

Commercial Ancillary Services

Ancillary Services, other than **System Ancillary Services**, utilised by NGET in operating the **Total System** if a **User** (or other person) has agreed to provide them under an **Ancillary Services Agreement** or under a **Bilateral Agreement** with payment being dealt with under an **Ancillary Services Agreement** or in the case of **Externally Interconnected System Operators** or **Interconnector Users**, under any other agreement (and in the case of **Externally Interconnected System Operators** and **Interconnector Users** includes ancillary services equivalent to or similar to **System Ancillary Services**).

Committed Project Planning Data

Data relating to a **User Development** once the offer for a **CUSC Contract** is accepted.

<u>Completion Date</u>	Has the meaning set out in the Bilateral Agreement with each User to that term or in the absence of that term to such other term reflecting the date when a User is expected to connect to or start using the GB Transmission System .
<u>Complex</u>	A Connection Site together with the associated Power Station and/or Network Operator substation and/or associated Plant and/or Apparatus , as appropriate.
<u>Connection Conditions or CC</u>	That portion of the Grid Code which is identified as the Connection Conditions .
<u>Connection Entry Capacity</u>	Has the meaning set out in the CUSC
<u>Connected Planning Data</u>	Data which replaces data containing estimated values assumed for planning purposes by validated actual values and updated estimates for the future and by updated forecasts for Forecast Data items such as Demand .
<u>Connection Point</u>	A Grid Supply Point or Grid Entry Point , as the case may be.
<u>Connection Site</u>	A Transmission Site or User Site , as the case may be.
<u>Construction Agreement</u>	Has the meaning set out in the CUSC
<u>Contingency Reserve</u>	The margin of generation over forecast Demand which is required in the period from 24 hours ahead down to real time to cover against uncertainties in Large Power Station availability and against both weather forecast and Demand forecast errors.
<u>Control Calls</u>	A telephone call whose destination and/or origin is a key on the control desk telephone keyboard at a Transmission Control Centre and which has the right to exercise priority over (ie. disconnect) a call of a lower status.
<u>Control Centre</u>	A location used for the purpose of control and operation of the GB Transmission System or DC Converter Station owner's System or a User System other than a Generator's System or an External System .
<u>Control Engineer</u>	A person nominated by the relevant party for the control of its Plant and Apparatus .
<u>Control Person</u>	The term used as an alternative to " Safety Co-ordinator " on the Site Responsibility Schedule only.

<u>Control Phase</u>	The Control Phase follows on from the Programming Phase and covers the period down to real time.
<u>Control Point</u>	<p>The point from which:-</p> <p>a) A Non-Embedded Customer's Plant and Apparatus is controlled; or</p> <p>b) A BM Unit at a Large Power Station or at a Medium Power Station or representing a Cascade Hydro Scheme or with a Demand Capacity with a magnitude of 50MW or more (in England and Wales) or 5MW or more (in Scotland), is physically controlled by a BM Participant; or</p> <p>c) In the case of any other BM Unit or Generating Unit, data submission is co-ordinated for a BM Participant and instructions are received from NGET,</p> <p>as the case may be. For a Generator this will normally be at a Power Station but may be at an alternative location agreed with NGET. In the case of a DC Converter Station, the Control Point will be at a location agreed with NGET. In the case of a BM Unit of an Interconnector User, the Control Point will be the Control Centre of the relevant Externally Interconnected System Operator.</p>
<u>Control Telephony</u>	The method by which a User's Responsible Engineer/Operator and NGET Control Engineer(s) speak to one another for the purposes of control of the Total System in both normal and emergency operating conditions.
<u>CUSC</u>	Has the meaning set out in NGET's Transmission Licence
<u>CUSC Contract</u>	<p>One or more of the following agreements as envisaged in Standard Condition C1 of NGET's Transmission Licence:</p> <p>(a) the CUSC Framework Agreement;</p> <p>(b) a Bilateral Agreement;</p> <p>(c) a Construction Agreement</p> <p>or a variation to an existing Bilateral Agreement and/or Construction Agreement;</p>
<u>CUSC Framework Agreement</u>	Has the meaning set out in NGET's Transmission Licence
<u>Customer</u>	A person to whom electrical power is provided (whether or not he is the same person as the person who provides the electrical power).
<u>Customer Demand Management</u>	Reducing the supply of electricity to a Customer or disconnecting a Customer in a manner agreed for commercial purposes between a Supplier and its Customer .

Customer Demand Management Notification Level

The level above which a **Supplier** has to notify **NGET** of its proposed or achieved use of **Customer Demand Management** which is 12 MW in England and Wales and 5 MW in Scotland.

Customer Generating Plant

A **Power Station** or **Generating Unit** of a **Customer** to the extent that it operates the same exclusively to supply all or part of its own electricity requirements, and does not export electrical power to any part of the **Total System**.

Data Registration Code or DRC

That portion of the **Grid Code** which is identified as the **Data Registration Code**.

Data Validation, Consistency and Defaulting Rules

The rules relating to validity and consistency of data, and default data to be applied, in relation to data submitted under the **Balancing Codes**, to be applied by **NGET** under the **Grid Code** as set out in the document "Data Validation, Consistency and Defaulting Rules" - Issue 7, dated 11th October 2004. The document is available on the National Grid website or upon request from **NGET**.

DC Converter

Any **Apparatus** with a **Completion Date** after 1 April 2005 used to convert alternating current electricity to direct current electricity, or vice-versa. A **DC Converter** is a standalone operative configuration at a single site comprising one or more converter bridges, together with one or more converter transformers, converter control equipment, essential protective and switching devices and auxiliaries, if any, used for conversion. In a bipolar arrangement, a **DC Converter** represents the bipolar configuration.

DC Converter Station

An installation comprising one or more **DC Converters** connecting a direct current interconnector:

to the **NGET Transmission System**; or,

(if the installation has a rating of 50MW or more) to a **User System**,

and it shall form part of the **External Interconnection** to which it relates.

DC Network

All items of **Plant** and **Apparatus** connected together on the direct current side of a **DC Converter**.

De-Load

The condition in which a **Genset** has reduced or is not delivering electrical power to the **System** to which it is **Synchronised**.

Demand

The demand of MW and Mvar of electricity (i.e. both **Active** and **Reactive Power**), unless otherwise stated.

<u>Demand Capacity</u>	Has the meaning as set out in the BSC .
<u>Demand Control</u>	Any or all of the following methods of achieving a Demand reduction: <ul style="list-style-type: none"> (a) Customer voltage reduction initiated by Network Operators (other than following an instruction from NGET); (b) Customer Demand reduction by Disconnection initiated by Network Operators (other than following an instruction from NGET); (c) Demand reduction instructed by NGET; (d) automatic low Frequency Demand Disconnection; (e) emergency manual Demand Disconnection.
<u>Demand Control Notification Level</u>	The level above which a Network Operator has to notify NGET of its proposed or achieved use of Demand Control which is 12 MW in England and Wales and 5 MW in Scotland.
<u>Designed Minimum Operating Level</u>	The output (in whole MW) below which a Genset or a DC Converter at a DC Converter Station (in any of its operating configurations) has no High Frequency Response capability.
<u>De-Synchronise</u>	<ul style="list-style-type: none"> a) The act of taking a Generating Unit, Power Park Module or DC Converter off a System to which it has been Synchronised, by opening any connecting circuit breaker; or b) The act of ceasing to consume electricity at an importing BM Unit; <p>and the term "De-Synchronising" shall be construed accordingly.</p>
<u>De-synchronised Island(s)</u>	Has the meaning set out in OC9.5.1(a)
<u>Detailed Planning Data</u>	Detailed additional data which NGET requires under the PC in support of Standard Planning Data . Generally it is first supplied once a Bilateral Agreement is entered into.
<u>Discrimination</u>	The quality where a relay or protective system is enabled to pick out and cause to be disconnected only the faulty Apparatus .
<u>Disconnection</u>	The physical separation of Users (or Customers) from the GB Transmission System or a User System as the case may be.
<u>Disputes Resolution Procedure</u>	The procedure described in the CUSC relating to disputes resolution.

<u>Distribution Code</u>	The distribution code required to be drawn up by each Electricity Distribution Licence holder and approved by the Authority , as from time to time revised with the approval of the Authority .
<u>Droop</u>	The ratio of the steady state change in speed in the case of a Generating Unit , or in Frequency in the case of a Power Park Module , to the steady state change in power output of the Generating Unit or Power Park Module .
<u>Dynamic Parameters</u>	Those parameters listed in Appendix 1 to BC1 under the heading BM Unit Data – Dynamic Parameters .
<u>Earth Fault Factor</u>	At a selected location of a three-phase System (generally the point of installation of equipment) and for a given System configuration, the ratio of the highest root mean square phase-to-earth power Frequency voltage on a sound phase during a fault to earth (affecting one or more phases at any point) to the root mean square phase-to-earth power Frequency voltage which would be obtained at the selected location without the fault.
<u>Earthing</u>	<p>A way of providing a connection between conductors and earth by an Earthing Device which is either:</p> <p>(a) Immobilised and Locked in the earthing position. Where the Earthing Device is Locked with a Safety Key, the Safety Key must be secured in a Key Safe and the Key Safe Key must be, where reasonably practicable, given to the authorised site representative of the Requesting Safety Co-Ordinator and is to be retained in safe custody. Where not reasonably practicable the Key Safe Key must be retained by the authorised site representative of the Implementing Safety Co-Ordinator in safe custody: or</p> <p>(b) maintained and/or secured in position by such other method which must be in accordance with the Local Safety Instructions of NGET or the Safety Rules of the Relevant Transmission Licensee or that User, as the case may be.</p>
<u>Earthing Device</u>	A means of providing a connection between a conductor and earth being of adequate strength and capability.
<u>Electrical Standard</u>	A standard listed in the Annex to the General Conditions .
<u>Electricity Council</u>	That body set up under the Electricity Act, 1957.
<u>Electricity Distribution Licence</u>	The licence granted pursuant to Section 6(1) (c) of the Act .

Electricity Supply Industry Arbitration Association

The unincorporated members' club of that name formed inter alia to promote the efficient and economic operation of the procedure for the resolution of disputes within the electricity supply industry by means of arbitration or otherwise in accordance with its arbitration rules.

Electricity Supply Licence

The licence granted pursuant to Section 6(1) (d) of the **Act**.

Electromagnetic Compatibility Level

Has the meaning set out in **Engineering Recommendation G5/4**.

Embedded

Having a direct connection to a **User System** or the **System** of any other **User** to which **Customers** and/or **Power Stations** are connected, such connection being either a direct connection or a connection via a busbar of another **User** or of a **Transmission Licensee** (but with no other connection to the **GB Transmission System**).

Emergency Instruction

An instruction issued by **NGET** in emergency circumstances, pursuant to BC2.9, to the **Control Point** of a **User**. In the case of such instructions applicable to a **BM Unit**, it may require an action or response which is outside the **Dynamic Parameters**, **QPN** or **Other Relevant Data**, and may include an instruction to trip a **Genset**.

Engineering Recommendations

The documents referred to as such and issued by the Electricity Association or the former Electricity Council.

Estimated Registered Data

Those items of **Standard Planning Data** and **Detailed Planning Data** which either upon connection will become **Registered Data**, or which for the purposes of the **Plant** and/or **Apparatus** concerned as at the date of submission are **Registered Data**, but in each case which for the seven succeeding **Financial Years** will be an estimate of what is expected.

European Specification

A common technical specification, a **British Standard** implementing a European standard or a European technical approval. The terms "common technical specification", "European standard" and "European technical approval" shall have the meanings respectively ascribed to them in the **Regulations**.

Event

An unscheduled or unplanned (although it may be anticipated) occurrence on, or relating to, a **System** (including **Embedded Power Stations**) including, without limiting that general description, faults, incidents and breakdowns and adverse weather conditions being experienced.

Exciter

The source of the electrical power providing the field current of a synchronous machine.

<u>Excitation System</u>	The equipment providing the field current of a machine, including all regulating and control elements, as well as field discharge or suppression equipment and protective devices.
<u>Excitation System No-Load Negative Ceiling Voltage</u>	The minimum value of direct voltage that the Excitation System is able to provide from its terminals when it is not loaded, which may be zero or a negative value.
<u>Excitation System Nominal Response</u>	Shall have the meaning ascribed to that term in IEC 34-16-1:1991 [equivalent to British Standard BS4999 Section 116.1 : 1992]. The time interval applicable is the first half-second of excitation system voltage response.
<u>Excitation System On-Load Positive Ceiling Voltage</u>	Shall have the meaning ascribed to the term 'Excitation system on load ceiling voltage' in IEC 34-16-1:1991 [equivalent to British Standard BS4999 Section 116.1 : 1992].
<u>Excitation System No-Load Positive Ceiling Voltage</u>	Shall have the meaning ascribed to the term 'Excitation system no load ceiling voltage' in IEC 34-16-1:1991 [equivalent to British Standard BS4999 Section 116.1 : 1992].
<u>Exemptable</u>	Has the meaning set out in the CUSC .
<u>Existing AGR Plant</u>	The following nuclear advanced gas cooled reactor plant (which was commissioned and connected to the Total System at the Transfer Date):- <p style="margin-left: 40px;">Dungeness B Hinkley Point B Heysham 1 Heysham 2 Hartlepool Hunterston B Torness.</p>
<u>Existing AGR Plant Flexibility Limit</u>	In respect of each Genset within each Existing AGR Plant which has a safety case enabling it to so operate, 8 (or such lower number which when added to the number of instances of reduction of output as instructed by NGET in relation to operation in Frequency Sensitive Mode totals 8) instances of flexibility in any calendar year (or such lower or greater number as may be agreed by the Nuclear Installations Inspectorate and notified to NGET) for the purpose of assisting in the period of low System NRAPM and/or low Localised NRAPM provided that in relation to each Generating Unit each change in output shall not be required to be to a level where the output of the reactor is less than 80% of the reactor thermal power limit (as notified to NGET and which corresponds to the limit of reactor thermal power as contained in the "Operating Rules" or "Identified Operating Instructions" forming part of the safety case agreed with the Nuclear Installations Inspectorate).

Existing Gas Cooled Reactor Plant

Both **Existing Magnox Reactor Plant** and **Existing AGR Plant**.

Existing Magnox Reactor Plant

The following nuclear gas cooled reactor plant (which was commissioned and connected to the **Total System** at the **Transfer Date**):-

Calder Hall
Chapelcross
Dungeness A
Hinkley Point A
Oldbury-on-Severn
Bradwell
Sizewell A
Wylfa.

Export and Import Limits

Those parameters listed in Appendix 1 to **BC1** under the heading **BM Unit Data – Export and Import Limits**.

External Interconnection

Apparatus for the transmission of electricity to or from the **GB Transmission System** or a **User System** into or out of an **External System**. For the avoidance of doubt, a single **External Interconnection** may comprise several circuits operating in parallel.

Externally Interconnected System Operator or EISO

A person who operates an **External System** which is connected to the **GB Transmission System** or a **User System** by an **External Interconnection**.

External System

In relation to an **Externally Interconnected System Operator** means the transmission or distribution system which it owns or operates which is located outside **Great Britain** and any **Apparatus** or **Plant** which connects that system to the **External Interconnection** and which is owned or operated by such **Externally Interconnected System Operator**.

Fault Current Interruption Time

The time interval from fault inception until the end of the break time of the circuit breaker (as declared by the manufacturers).

Fast Start

A start by a **Genset** with a **Fast Start Capability**.

Fast Start Capability

The ability of a **Genset** to be **Synchronised** and **Loaded** up to full **Load** within 5 minutes.

Final Generation Outage Programme

An outage programme as agreed by **NGET** with each **Generator** at various stages through the **Operational Planning Phase** and **Programming Phase** which does not commit the parties to abide by it, but which at various stages will be used as the basis on which **GB Transmission System** outages will be planned.

<u>Final Physical Notification Data</u>	Has the meaning set out in the BSC .
<u>Final Report</u>	A report prepared by the Test Proposer at the conclusion of a System Test for submission to NGET (if it did not propose the System Test) and other members of the Test Panel .
<u>Financial Year</u>	Bears the meaning given in Condition A1 (Definitions and Interpretation) of NGET's Transmission Licence .
<u>Flicker Severity (Long Term)</u>	A value derived from 12 successive measurements of Flicker Severity (Short Term) (over a two hour period) and a calculation of the cube root of the mean sum of the cubes of 12 individual measurements, as further set out in Engineering Recommendation P28 as current at the Transfer Date .
<u>Flicker Severity (Short Term)</u>	A measure of the visual severity of flicker derived from the time series output of a flickermeter over a 10 minute period and as such provides an indication of the risk of Customer complaints.
<u>Forecast Data</u>	Those items of Standard Planning Data and Detailed Planning Data which will always be forecast.
<u>Frequency</u>	The number of alternating current cycles per second (expressed in Hertz) at which a System is running.
<u>Frequency Sensitive AGR Unit</u>	Each Generating Unit in an Existing AGR Plant for which the Generator has notified NGET that it has a safety case agreed with the Nuclear Installations Inspectorate enabling it to operate in Frequency Sensitive Mode , to the extent that such unit is within its Frequency Sensitive AGR Unit Limit . Each such Generating Unit shall be treated as if it were operating in accordance with BC3.5.1 provided that it is complying with its Frequency Sensitive AGR Unit Limit .
<u>Frequency Sensitive AGR Unit Limit</u>	In respect of each Frequency Sensitive AGR Unit , 8 (or such lower number which when added to the number of instances of flexibility for the purposes of assisting in a period of low System or Localised NRAPM totals 8) instances of reduction of output in any calendar year as instructed by NGET in relation to operation in Frequency Sensitive Mode (or such greater number as may be agreed between NGET and the Generator), for the purpose of assisting with Frequency control, provided the level of operation of each Frequency Sensitive AGR Unit in Frequency Sensitive Mode shall not be outside that agreed by the Nuclear Installations Inspectorate in the relevant safety case.

Frequency Sensitive Mode

A **Genset** operating mode which will result in **Active Power** output changing, in response to a change in **System Frequency**, in a direction which assists in the recovery to **Target Frequency**, by operating so as to provide **Primary Response** and/or **Secondary Response** and/or **High Frequency Response**.

Fuel Security Code

The document of that title designated as such by the **Secretary of State**, as from time to time amended.

Gas Turbine Unit

A **Generating Unit** driven by a gas turbine (for instance by an aero-engine).

Gas Zone Diagram

A single line diagram showing boundaries of, and interfaces between, gas-insulated **HV Apparatus** modules which comprise part, or the whole, of a substation at a **Connection Site**, together with the associated stop valves and gas monitors required for the safe operation of the **GB Transmission System** or the **User System**, as the case may be.

Gate Closure

Has the meaning set out in the **BSC**.

GB National Demand

The amount of electricity supplied from the **Grid Supply Points** plus:-

- that supplied by **Embedded Large Power Stations**, and
- **GB Transmission System Losses**,

minus:-

- the **Demand** taken by **Station Transformers** and **Pumped Storage Units'**

and, for the purposes of this definition, does not include:-

- any exports from the **GB Transmission System** across **External Interconnections**.

GB Transmission System

The system consisting (wholly or mainly) of high voltage electric lines owned or operated by **Transmission Licensees** within **Great Britain** and used for the transmission of electricity from one **Power Station** to a substation or to another **Power Station** or between sub-stations or to or from any **External Interconnection**, and includes any **Plant** and **Apparatus** and meters owned or operated by any **Transmission Licensee** within **Great Britain** in connection with the transmission of electricity but does not include any **Remote Transmission Assets**.

GB Transmission System Demand

The amount of electricity supplied from the **Grid Supply Points** plus:-

- that supplied by **Embedded Large Power Stations**, and
- exports from the **GB Transmission System** across **External Interconnections**, and
- **GB Transmission System Losses**,

and, for the purposes of this definition, includes:-

- the **Demand** taken by **Station Transformers** and **Pumped Storage Units**.

GB Transmission System Losses

The losses of electricity incurred on the **GB Transmission System**.

GB Transmission System Study Network Data File

A computer file containing details of transmission plant and **Large Power Stations** and the configuration of the connection between them, together with data on **Demand** and on the **GB Transmission System**. These details, when read together as represented in the file, form **NGET's** view of an appropriate representation of the **GB Transmission System** for technical analysis purposes only. The file will only deal with the **GB Transmission System**

GB Transmission System Warning

A warning issued by **NGET** to **Users** (or to certain **Users** only) in accordance with OC7.4.8.2, which provides information relating to **System** conditions or **Events** and is intended to :

- (a) alert **Users** to possible or actual **Plant** shortage, **System** problems and/or **Demand** reductions;
- (b) inform of the applicable period;
- (c) indicate intended consequences for **Users**; and
- (d) enable specified **Users** to be in a state of readiness to receive instructions from **NGET**.

GB Transmission System Warning - Demand Control Imminent

A warning issued by **NGET**, in accordance with OC7.4.8.7, which is intended to provide short term notice, where possible, to those **Users** who are likely to receive **Demand** reduction instructions from **NGET** within 30 minutes.

GB Transmission System Warning - High Risk of Demand Reduction

A warning issued by **NGET**, in accordance with OC7.4.8.6, which is intended to alert recipients that there is a high risk of **Demand** reduction being implemented and which may normally result from an inadequate **System Margin**.

GB Transmission System Warning - Inadequate System Margin

A warning issued by **NGET**, in accordance with OC7.4.8.5, which is intended to alert recipients of an inadequate **System Margin** and which if not improved may result in **Demand** reduction being instructed.

GB Transmission System Warning - Risk of System Disturbance

A warning issued by **NGET**, in accordance with OC7.4.8.8, which is intended to alert **Users** of the risk of widespread and serious **System** disturbance which may affect **Users**.

General Conditions or GC

That portion of the **Grid Code** which is identified as the **General Conditions**.

Generating Plant Demand Margin

The difference between **Output Usable** and forecast **Demand**.

Generating Unit

Unless otherwise provided in the **Grid Code**, any **Apparatus** which produces electricity, including, a **Synchronous Generating Unit** and **Non-synchronous Generating Unit**.

Generating Unit Data

The **Physical Notification, Export and Import Limits and Other Relevant Data** only in respect of each **Generating Unit**:

(a) which forms part of the **BM Unit** which represents that **Cascade Hydro Scheme**;

at an **Embedded Exemptable Large Power Station**, where **NGET** reasonably requires compliance with relevant provisions of **BC1/BC2** on a **Generating Unit** basis and has specified such requirement in the relevant **Bilateral Agreement**.

Generation Capacity

Has the meaning set out in the **BSC**.

Generation Planning Parameters

Those parameters listed in Appendix 2 of **OC2**.

Generator

A person who generates electricity under licence or exemption under the **Act** acting in its capacity as a generator in **Great Britain**.

Generator Performance Chart

A diagram which shows the MW and Mvar capability limits within which a **Generating Unit** will be expected to operate under steady state conditions.

Genset

A **Generating Unit, Power Park Module** or **CCGT Module** at a **Large Power Station** or any **Generating Unit, Power Park Module** or **CCGT Module** which is directly connected to the **GB Transmission System**.

<u>Good Industry Practice</u>	The exercise of that degree of skill, diligence, prudence and foresight which would reasonably and ordinarily be expected from a skilled and experienced operator engaged in the same type of undertaking under the same or similar circumstances.
<u>Governor Deadband</u>	The total magnitude of the change in steady state speed (expressed as a range of Hz ($\pm x$ Hz) where "x" is a numerical value) within which there is no resultant change in the position of the governing valves of the speed/load Governing System.
<u>Great Britain or GB</u>	Has the meaning set out in Schedule 1 of NGET's Transmission Licence .
<u>Grid Code Review Panel or Panel</u>	The panel with the functions set out in GC.4.
<u>Grid Entry Point</u>	A point at which a Generating Unit or a CCGT Module or a CCGT Unit or a DC Converter or a Power Park Module , as the case may be, which is directly connected to the GB Transmission System connects to the GB Transmission System .
<u>Grid Supply Point</u>	A point of supply from the GB Transmission System to Network Operators or Non-Embedded Customers .
<u>Group</u>	Those GB Transmission System sub-stations bounded solely by the faulted circuit(s) and the overloaded circuit(s) excluding any third party connections between the Group and the rest of the GB Transmission System , the faulted circuit(s) being a Secured Event .
<u>High Frequency Response</u>	An automatic reduction in Active Power output in response to an increase in System Frequency above the Target Frequency (or such other level of Frequency as may have been agreed in an Ancillary Services Agreement). This reduction in Active Power output must be in accordance with the provisions of the relevant Ancillary Services Agreement which will provide that it will be released increasingly with time over the period 0 to 10 seconds from the time of the Frequency increase on the basis set out in the Ancillary Services Agreement and fully achieved within 10 seconds of the time of the start of the Frequency increase and it must be sustained at no lesser reduction thereafter. The interpretation of the High Frequency Response to a + 0.5 Hz frequency change is shown diagrammatically in Figure CC.A.3.3.
<u>High Voltage or HV</u>	In England and Wales, a voltage exceeding 650 volts. In Scotland, a voltage exceeding 1000 volts.
<u>HV Connections</u>	Apparatus connected at the same voltage as that of the GB Transmission System , including Users' circuits, the higher voltage windings of Users' transformers and associated connection Apparatus .

<u>HP Turbine Power Fraction</u>	Ratio of steady state mechanical power delivered by the HP turbine to the total steady state mechanical power delivered by the total steam turbine at Registered Capacity .
<u>IEC</u>	International Electrotechnical Commission.
<u>IEC Standard</u>	A standard approved by the International Electrotechnical Commission.
<u>Implementing Safety Co-ordinator</u>	The Safety Co-ordinator implementing Safety Precautions .
<u>Import Usable</u>	That portion of Registered Import Capacity which is expected to be available and which is not unavailable due to a Planned Outage .
<u>Incident Centre</u>	A centre established by NGET or a User as the focal point in NGET or in that User , as the case may be, for the communication and dissemination of information between the senior management representatives of NGET , or of that User , as the case may be, and the relevant other parties during a Joint System Incident in order to avoid overloading NGET's , or that User's , as the case may be, existing operational/control arrangements.
<u>Indicated Constraint Boundary Margin</u>	The difference between a constraint boundary transfer limit and the difference between the sum of BM Unit Maximum Export Limits and the forecast of local Demand within the constraint boundary.
<u>Indicated Imbalance</u>	The difference between the sum of Physical Notifications for BM Units comprising Generating Units or CCGT Modules and the forecast of Demand for the whole or any part of the System .
<u>Indicated Margin</u>	The difference between the sum of BM Unit Maximum Export Limits submitted and the forecast of Demand for the whole or any part of the System
<u>Instructor Facilities</u>	A device or system which gives certain Transmission Control Centre instructions with an audible or visible alarm, and incorporates the means to return message acknowledgements to the Transmission Control Centre
<u>Integral Equipment Test or IET</u>	A test on equipment, associated with Plant and/or Apparatus , which takes place when that Plant and/or Apparatus forms part of a Synchronised System and which, in the reasonable judgement of the person wishing to perform the test, may cause an Operational Effect .

<u>Interconnection Agreement</u>	An agreement made between NGET and an Externally Interconnected System Operator and/or an Interconnector User and/or other relevant persons for the External Interconnection relating to an External Interconnection and/or an agreement under which an Interconnector User can use an External Interconnection .
<u>Interconnector User</u>	Has the meaning set out in the BSC .
<u>Interface Agreement</u>	Has the meaning set out in the CUSC .
<u>Intermittent Power Source</u>	The primary source of power for a Generating Unit that can not be considered as controllable, e.g. wind, wave or solar.
<u>Intertripping</u>	(a) The tripping of circuit-breaker(s) by commands initiated from Protection at a remote location independent of the state of the local Protection ; or (b) Operational Intertripping .
<u>Intertrip Apparatus</u>	Apparatus which performs Intertripping .
<u>IP Turbine Power Fraction</u>	Ratio of steady state mechanical power delivered by the IP turbine to the total steady state mechanical power delivered by the total steam turbine at Registered Capacity .
<u>Isolating Device</u>	A device for achieving Isolation .

Isolation

The disconnection of **HV Apparatus** (as defined in OC8A.1.6.2 and OC8B.1.7.2) from the remainder of the **System** in which that **HV Apparatus** is situated by either of the following:

- (a) an **Isolating Device** maintained in an isolating position. The isolating position must either be:
 - (i) maintained by immobilising and **Locking** the **Isolating Device** in the isolating position and affixing a **Caution Notice** to it. Where the **Isolating Device** is **Locked** with a **Safety Key**, the **Safety Key** must be secured in a **Key Safe** and the **Key Safe Key** must be, where reasonably practicable, given to the authorised site representative of the **Requesting Safety Co-Ordinator** and is to be retained in safe custody. Where not reasonably practicable the **Key Safe Key** must be retained by the authorised site representative of the **Implementing Safety Co-Ordinator** in safe custody; or
 - (ii) maintained and/or secured by such other method which must be in accordance with the **Local Safety Instructions** of **NGET** or the **Safety Rules** of the **Relevant Transmission Licensee** or that **User**, as the case may be; or
- (b) an adequate physical separation which must be in accordance with and maintained by the method set out in the **Local Safety Instructions** of **NGET** or the **Safety Rules** of the **Relevant Transmission Licensee** or that **User**, as the case may be.

Joint BM Unit Data

Has the meaning set out in the **BSC**.

Joint System Incident

An **Event** wherever occurring (other than on an **Embedded Medium Power Station** or an **Embedded Small Power Station**) which, in the opinion of **NGET** or a **User**, has or may have a serious and/or widespread effect, in the case of an **Event** on a **User(s) System(s)** (other than on an **Embedded Medium Power Station** or **Embedded Small Power Station**), on the **GB Transmission System**, and in the case of an **Event** on the **GB Transmission System**, on a **User(s) System(s)** (other than on an **Embedded Medium Power Station** or **Embedded Small Power Station**).

Key Safe

A device for the secure retention of keys.

Key Safe Key

A key unique at a **Location** capable of operating a lock, other than a control lock, on a **Key Safe**.

Large Power Station

A **Power Station** in **NGET's Transmission Area** with a **Registered Capacity** of 100MW or more or a **Power Station** in **SPT's Transmission Area** with a **Registered Capacity** of 30MW or more; or a **Power Station** in **SHETL's Transmission Area** with a **Registered Capacity** of 5MW or more.

<u>Licence</u>	Any licence granted to NGET or a Relevant Transmission Licensee or a User , under Section 6 of the Act .
<u>Licence Standards</u>	Those standards set out or referred to in Condition C17 of NGET's Transmission Licence and/or Condition D3 of a Relevant Transmission Licensee's Transmission Licence .
<u>Limited Frequency Sensitive Mode</u>	A mode whereby the operation of the Genset (or DC Converter at a DC Converter Station exporting Active Power to the Total System) is Frequency insensitive except when the System Frequency exceeds 50.4Hz, from which point Limited High Frequency Response must be provided.
<u>Limited High Frequency Response</u>	A response of a Genset (or DC Converter at a DC Converter Station exporting Active Power to the Total System) to an increase in System Frequency above 50.4Hz leading to a reduction in Active Power in accordance with the provisions of BC3.7.2.
<u>Load</u>	The Active , Reactive or Apparent Power , as the context requires, generated, transmitted or distributed.
<u>Loaded</u>	Supplying electrical power to the System .
<u>Load Factor</u>	The ratio of the actual output of a Generating Unit to the possible maximum output of that Generating Unit .
<u>Load Management Block</u>	A block of Demand controlled by a Supplier or other party through the means of radio teleswitching or by some other means.
<u>Local Joint Restoration Plan</u>	<p>A plan produced under OC9.4.7.11 detailing the agreed method and procedure by which a Genset at a Black Start Station (possibly with other Gensets at that Black Start Station) will energise part of the Total System and meet complementary blocks of local Demand so as to form a Power Island.</p> <p>In Scotland, the plan may also: cover more than one Black Start Station; include Gensets other than those at a Black Start Station and cover the creation of one or more Power Islands.</p>
<u>Local Safety Instructions</u>	For safety co-ordination in England and Wales, instructions on each User Site and Transmission Site , approved by the relevant NGET or User's manager, setting down the methods of achieving the objectives of NGET's or the User's Safety Rules , as the case may be, to ensure the safety of personnel carrying out work or testing on Plant and/or Apparatus on which his Safety Rules apply and, in the case of a User , any other document(s) on a User Site which contains rules with regard to maintaining or securing the isolating position of an Isolating Device , or maintaining a physical separation or maintaining or securing the position of an Earthing Device .

<u>Local Switching Procedure</u>	A procedure produced under OC7.6 detailing the agreed arrangements in respect of carrying out of Operational Switching at Connection Sites and parts of the GB Transmission System adjacent to those Connection Sites .
<u>Localised Negative Reserve Active Power Margin or Localised NRAPM</u>	That margin of Active Power sufficient to allow transfers to and from a System Constraint Group (as the case may be) to be contained within such reasonable limit as NGET may determine.
<u>Location</u>	Any place at which Safety Precautions are to be applied.
<u>Locked</u>	A condition of HV Apparatus that cannot be altered without the operation of a locking device.
<u>Locking</u>	The application of a locking device which enables HV Apparatus to be Locked .
<u>Low Frequency Relay</u>	Has the same meaning as Under Frequency Relay .
<u>Low Voltage or LV</u>	In England and Wales a voltage not exceeding 250 volts. In Scotland, a voltage exceeding 50 voltage but not exceeding 1000 volts.
<u>Main Protection</u>	Protection equipment or system expected to have priority in initiating either a fault clearance or an action to terminate an abnormal condition in a power system.
<u>Material Effect</u>	An effect causing NGET or a Relevant Transmission Licensee to effect any works or to alter the manner of operation of Transmission Plant and/or Transmission Apparatus at the Connection Site (which term shall, in this definition and in the definition of “ Modification ” only, have the meaning ascribed thereto in the CUSC) or the site of connection or a User to effect any works or to alter the manner of operation of its Plant and/or Apparatus at the Connection Site or the site of connection which in either case involves that party in expenditure of more than £10,000.
<u>Maximum Generation Service, MGS</u>	A service utilised by NGET in accordance with the CUSC and the Balancing Principles Statement in operating the Total System .
<u>Maximum Generation Service Agreement</u>	An agreement between a User and NGET for the payment by NGET to that User in respect of the provision by such User of a Maximum Generation Service .
<u>Medium Power Station</u>	A Power Station in NGET’s Transmission Area with a Registered Capacity of 50MW or more, but less than 100MW; or a Power Station in SPT’s Transmission Area with a Registered Capacity of 5MW or more, but less than 30MW.

<u>Medium Voltage or MV</u>	In England and Wales a voltage exceeding 250 volts but not exceeding 650 volts.
<u>Mills</u>	Milling plant which supplies pulverised fuel to the boiler of a coal fired Power Station .
<u>Minimum Generation</u>	The minimum output (in whole MW) which a Genset can generate or DC Converter at a DC Converter Station can import or export to the Total System under stable operating conditions, as registered with NGET under the PC (and amended pursuant to the PC). For the avoidance of doubt, the output may go below this level as a result of operation in accordance with BC3.7.
<u>Minimum Import Capacity</u>	The minimum input (in whole MW) into a DC Converter at a DC Converter Station (in any of its operating configurations) at the Grid Entry Point (or in the case of an Embedded DC Converter at the User System Entry Point) at which a DC Converter can operate in a stable manner, as registered with NGET under the PC (and amended pursuant to the PC).
<u>Modification</u>	Any actual or proposed replacement, renovation, modification, alteration or construction by or on behalf of a User or NGET to either that User's Plant or Apparatus or Transmission Plant or Apparatus , as the case may be, or the manner of its operation which has or may have a Material Effect on NGET or a User , as the case may be, at a particular Connection Site .
<u>Mothballed DC Converter at a DC Converter Station</u>	A DC Converter at a DC Converter Station that has previously imported or exported power which the DC Converter Station owner plans not to use to import or export power for the remainder of the current Financial Year but which could be returned to service.
<u>Mothballed Generating Unit</u>	A Generating Unit that has previously generated which the Generator plans not to use to generate for the remainder of the current NGET Financial Year but which could be returned to service.
<u>Mothballed Power Park Module</u>	A Power Park Module that has previously generated which the Generator plans not to use to generate for the remainder of the current Financial Year but which could be returned to service.
<u>Multiple Point of Connection</u>	A double (or more) Point of Connection , being two (or more) Points of Connection interconnected to each other through the User's System .
<u>Network Data</u>	The data to be provided by NGET to Users in accordance with the PC , as listed in Part 3 of the Appendix to the PC .

<u>Network Operator</u>	A person with a User System directly connected to the GB Transmission System to which Customers and/or Power Stations (not forming part of the User System) are connected, acting in its capacity as an operator of the User System , but shall not include a person acting in the capacity of an Externally Interconnected System Operator .
<u>NGET</u>	National Grid Electricity Transmission plc (NO: 2366977) whose registered office is at 1-3 Strand, London, WC2N 5EH.
<u>NGET Control Engineer</u>	The nominated person employed by NGET to direct the operation of the GB Transmission System or such person as nominated by NGET .
<u>NGET Operational Strategy</u>	NGET's operational procedures which form the guidelines for operation of the GB Transmission System .
<u>No-Load Field Voltage</u>	Shall have the meaning ascribed to that term in IEC 34-16-1:1991 [equivalent to British Standard BS4999 Section 116.1 : 1992].
<u>Non-Embedded Customer</u>	A Customer in Great Britain , except for a Network Operator acting in its capacity as such, receiving electricity direct from the GB Transmission System irrespective of from whom it is supplied.
<u>Non-Synchronous Generating Unit</u>	A Generating Unit that is not a Synchronous Generating Unit including for the avoidance of doubt a Power Park Unit .
<u>Normal CCGT Module</u>	A CCGT Module other than a Range CCGT Module .
<u>Novel Unit</u>	A tidal, wave, wind, geothermal, or any similar, Generating Unit .
<u>OC9 De-synchronised Island Procedure</u>	Has the meaning set out in OC9.5.4.
<u>On-Site Generator Site</u>	A site which is determined by the BSC Panel to be a Trading Unit under the BSC by reason of having fulfilled the Class 1 or Class 2 requirements as such terms are used in the BSC .
<u>Operating Code or OC</u>	That portion of the Grid Code which is identified as the Operating Code .
<u>Operating Margin</u>	Contingency Reserve plus Operating Reserve .

<u>Operating Reserve</u>	The additional output from Large Power Stations or the reduction in Demand , which must be realisable in real-time operation to respond in order to contribute to containing and correcting any System Frequency fall to an acceptable level in the event of a loss of generation or a loss of import from an External Interconnection or mismatch between generation and Demand .
<u>Operation</u>	A scheduled or planned action relating to the operation of a System (including an Embedded Power Station).
<u>Operational Data</u>	Data required under the Operating Codes and/or Balancing Codes .
<u>Operational Day</u>	The period from 0500 hours on one day to 0500 on the following day.
<u>Operation Diagrams</u>	Diagrams which are a schematic representation of the HV Apparatus and the connections to all external circuits at a Connection Site , incorporating its numbering, nomenclature and labelling.
<u>Operational Effect</u>	Any effect on the operation of the relevant other System which causes the GB Transmission System or the System of the other User or Users , as the case may be, to operate (or be at a materially increased risk of operating) differently to the way in which they would or may have operated in the absence of that effect.
<u>Operational Intertripping</u>	The automatic tripping of circuit-breakers to prevent abnormal system conditions occurring, such as over voltage, overload, System instability, etc. after the tripping of other circuit-breakers following power System fault(s) which includes System to Generating Unit , System to CCGT Module , System to Power Park Module , System to DC Converter and System to Demand intertripping schemes.
<u>Operational Planning</u>	Planning through various timescales the matching of generation output with forecast GB Transmission System Demand together with a reserve of generation to provide a margin, taking into account outages of certain Generating Units , of parts of the GB Transmission System and of parts of User Systems to which Power Stations and/or Customers are connected, carried out to achieve, so far as possible, the standards of security set out in NGET's Transmission Licence , each Relevant Transmission Licensee's Transmission Licence or Electricity Distribution Licence , as the case may be.
<u>Operational Planning Margin</u>	An operational planning margin set by NGET .
<u>Operational Planning Phase</u>	The period from 8 weeks to the end of the 5 th year ahead of real time operation.

<u>Operational Procedures</u>	Management instructions and procedures, both in support of the Safety Rules and for the local and remote operation of Plant and Apparatus , issued in connection with the actual operation of Plant and/or Apparatus at or from a Connection Site .
<u>Operational Switching</u>	Operation of Plant and/or Apparatus to the instruction of the relevant Control Engineer . For the avoidance of doubt, the operation of Transmission Plant and/or Apparatus forming part of the GB Transmission System in England and Wales, will be to the instruction of NGET and in Scotland will be to the instruction of the Relevant Transmission Licensee .
<u>Other Relevant Data</u>	The data listed in BC1.4.2(f) under the heading Other Relevant Data
<u>Out of Synchronism</u>	The condition where a System or Generating Unit cannot meet the requirements to enable it to be Synchronised .
<u>Output Usable or OU</u>	The (daily or weekly) forecast value (in MW), at the time of the (daily or weekly) peak demand, of the maximum level at which the Genset can export to the Grid Entry Point , or in the case of Embedded Power Stations , to the User System Entry Point .
<u>Over-excitation Limiter</u>	Shall have the meaning ascribed to that term in IEC 34-16-1:1991 [equivalent to British Standard BS4999 Section 116.1 : 1992].
<u>Part 1 System Ancillary Services</u>	Ancillary Services which are required for System reasons and which must be provided by Users in accordance with the Connection Conditions . An exhaustive list of Part 1 System Ancillary Services is included in that part of CC.8.1 headed Part 1.
<u>Part 2 System Ancillary Services</u>	Ancillary Services which are required for System reasons and which must be provided by a User if the User has agreed to provide them under a Bilateral Agreement . A non-exhaustive list of Part 2 System Ancillary Services is included in that part of CC.8.1 headed Part 2.
<u>Part Load</u>	The condition of a Genset , or Cascade Hydro Scheme which is Loaded but is not running at its Maximum Export Limit.

Permit for Work for proximity work

In England and Wales, a document issued by **NGET** or a **User** in accordance with its respective **Safety Rules** to enable work to be carried out in accordance with OC8A.8 and which provides for **Safety Precautions** to be applied and maintained. An example format of **NGET's** permit for work is attached as Appendix E to **OC8A**.

In Scotland, a document issued by a **Relevant Transmission Licensee** or a **User** in accordance with its respective **Safety Rules** to enable work to be carried out in accordance with OC8B.8 and which provides for **Safety Precautions** to be applied and maintained. Example formats of the **Relevant Transmission Licensees'** permits for work are attached as Appendix E to **OC8B**.

Partial Shutdown

The same as a **Total Shutdown** except that all generation has ceased in a separate part of the **Total System** and there is no electricity supply from **External Interconnections** or other parts of the **Total System** to that part of the **Total System** and, therefore, that part of the **Total System** is shutdown, with the result that it is not possible for that part of the **Total System** to begin to function again without **NGET's** directions relating to a **Black Start**.

Phase (Voltage) Unbalance

The ratio (in percent) between the rms values of the negative sequence component and the positive sequence component of the voltage.

Physical Notification

Data that describes the **BM Participant's** best estimate of the expected input or output of **Active Power** of a **BM Unit** and/or (where relevant) **Generating Unit**.

Planning Code or PC

That portion of the **Grid Code** which is identified as the **Planning Code**.

Planned Maintenance Outage

An outage of **NGET** electronic data communication facilities as provided for in CC.6.5.8 and **NGET's** associated computer facilities of which normally at least 5 days notice is given, but in any event of which at least twelve hours notice has been given by **NGET** to the **User** and which is anticipated to last no longer than 2 hours. The length of such an outage may in exceptional circumstances be extended where at least 24 hours notice has been given by **NGET** to the **User**. It is anticipated that normally any planned outage would only last around one hour.

Planned Outage

An outage of a **Large Power Station** or of part of the **GB Transmission System**, or of part of a **User System**, co-ordinated by **NGET** under **OC2**.

Plant

Fixed and movable items used in the generation and/or supply and/or transmission of electricity, other than **Apparatus**.

Point of Common Coupling

That point on the **GB Transmission System** electrically nearest to the **User** installation at which either **Demands** or **Loads** are, or may be, connected.

<u>Point of Connection</u>	An electrical point of connection between the GB Transmission System and a User's System .
<u>Point of Isolation</u>	The point on Apparatus (as defined in OC8A.1.6.2 and OC8B.1.7.2) at which Isolation is achieved.
<u>Post-Control Phase</u>	The period following real time operation.
<u>Power Factor</u>	The ratio of Active Power to Apparent Power .
<u>Power Island</u>	Gensets at an isolated Power Station , together with complementary local Demand . In Scotland a Power Island may include more than one Power Station .
<u>Power Park Module</u>	A collection of Non-synchronous Generating Units (registered as a Power Park Module under the PC) that are powered by an Intermittent Power Source , joined together by a System with a single electrical point of connection to the GB Transmission System (or User System if Embedded). The connection to the GB Transmission System (or User System if Embedded) may include a DC Converter .
<u>Power Park Module Availability Matrix</u>	The matrix described in Appendix 1 to BC1 under the heading Power Park Module Availability Matrix .
<u>Power Park Module Planning Matrix</u>	A matrix in the form set out in Appendix 4 of OC2 showing the combination of Power Park Units within a Power Park Module which would be expected to be running under normal conditions.
<u>Power Park Unit</u>	A Generating Unit within a Power Park Module .
<u>Power Station</u>	An installation comprising one or more Generating Units or Power Park Modules (even where sited separately) owned and/or controlled by the same Generator , which may reasonably be considered as being managed as one Power Station .
<u>Power System Stabiliser or PSS</u>	Equipment controlling the Exciter output via the voltage regulator in such a way that power oscillations of the synchronous machines are dampened. Input variables may be speed, frequency or power (or a combination of these).
<u>Preface</u>	The preface to the Grid Code (which does not form part of the Grid Code and therefore is not binding).
<u>Preliminary Notice</u>	A notice in writing, sent by NGET both to all Users identified by it under OC12.4.2.1 and to the Test Proposer , notifying them of a proposed System Test .

Preliminary Project Planning Data

Data relating to a proposed **User Development** at the time the **User** applies for a **CUSC Contract** but before an offer is made and accepted.

Primary Response

The automatic increase in **Active Power** output of a **Genset** or, as the case may be, the decrease in **Active Power Demand** in response to a **System Frequency** fall. This increase in **Active Power** output or, as the case may be, the decrease in **Active Power Demand** must be in accordance with the provisions of the relevant **Ancillary Services Agreement** which will provide that it will be released increasingly with time over the period 0 to 10 seconds from the time of the start of the **Frequency** fall on the basis set out in the **Ancillary Services Agreement** and fully available by the latter, and sustainable for at least a further 20 seconds. The interpretation of the **Primary Response** to a – 0.5 Hz frequency change is shown diagrammatically in Figure CC.A.3.2.

Programming Phase

The period between **Operational Planning Phase** and the **Control Phase**. It starts at the 8 weeks ahead stage and finishes at 17:00 on the day ahead of real time.

Proposal Notice

A notice submitted to **NGET** by a **User** which would like to undertake a **System Test**.

Proposal Report

A report submitted by the **Test Panel** which contains:

- a) proposals for carrying out a **System Test** (including the manner in which the **System Test** is to be monitored);
- b) an allocation of costs (including un-anticipated costs) between the affected parties (the general principle being that the **Test Proposer** will bear the costs); and
- c) such other matters as the **Test Panel** considers appropriate.

The report may include requirements for indemnities to be given in respect of claims and losses arising from a **System Test**.

Protection

The provisions for detecting abnormal conditions on a **System** and initiating fault clearance or actuating signals or indications.

Protection Apparatus

A group of one or more **Protection** relays and/or logic elements designated to perform a specified **Protection** function.

Pumped Storage Generator

A **Generator** which owns and/or operates any **Pumped Storage Plant**.

Pumped Storage Plant

The Dinorwig, Ffestiniog, Cruachan and Foyers **Power Stations**.

Pumped Storage Unit

A **Generating Unit** within a **Pumped Storage Plant**.

Quiescent Physical Notification or QPN

Data that describes the MW levels to be deducted from the **Physical Notification** of a **BM Unit** to determine a resultant operating level to which the **Dynamic Parameters** associated with that **BM Unit** apply, and the associated times for such MW levels. The MW level of the **QPN** must always be set to zero.

Range CCGT Module

A **CCGT Module** where there is a physical connection by way of a steam or hot gas main between that **CCGT Module** and another **CCGT Module** or other **CCGT Modules**, which connection contributes (if open) to efficient modular operation, and which physical connection can be varied by the operator.

Rated Field Voltage

Shall have the meaning ascribed to that term in **IEC 34-16-1:1991** [equivalent to **British Standard BS4999** Section 116.1 : 1992].

Rated MW

The “rating-plate” MW output of a **Generating Unit, Power Park Module** or **DC Converter**, being:

- (a) that output up to which the **Generating Unit** was designed to operate (Calculated as specified in **British Standard BS EN 60034 – 1: 1995**);
or
- (b) the nominal rating for the MW output of a **Power Park Module** being the maximum continuous electric output power which the **Power Park Module** was designed to achieve under normal operating conditions;
or
- (c) the nominal rating for the MW import capacity and export capacity (if at a **DC Converter Station**) of a **DC Converter**.

Reactive Energy

The integral with respect to time of the **Reactive Power**.

Reactive Power

The product of voltage and current and the sine of the phase angle between them measured in units of voltamperes reactive and standard multiples thereof, ie:

$$\begin{aligned} 1000 \text{ VAr} &= 1 \text{ kVAr} \\ 1000 \text{ kVAr} &= 1 \text{ Mvar} \end{aligned}$$

Record of Inter-System Safety Precautions or RISSP

A written record of inter-system **Safety Precautions** to be compiled in accordance with the provisions of **OC8**.

Registered Capacity

- (a) In the case of a **Generating Unit** other than that forming part of a **CCGT Module** or **Power Park Module**, the normal full load capacity of a **Generating Unit** as declared by the **Generator**, less the MW consumed by the **Generating Unit** through the **Generating Unit's Unit Transformer** when producing the same (the resultant figure being expressed in whole MW).
- (b) In the case of a **CCGT Module** or **Power Park Module**, the normal full load capacity of the **CCGT Module** or **Power Park Module** (as the case may be) as declared by the **Generator**, being the **Active Power** declared by the **Generator** as being deliverable by the **CCGT Module** or **Power Park Module** at the **Grid Entry Point** (or in the case of an **Embedded CCGT Module** or **Power Park Module**, at the **User System Entry Point**), expressed in whole MW.
- (c) In the case of a **Power Station**, the maximum amount of **Active Power** deliverable by the **Power Station** at the **Grid Entry Point** (or in the case of an **Embedded Power Station** at the **User System Entry Point**), as declared by the **Generator**, expressed in whole MW. The maximum **Active Power** deliverable is the maximum amount deliverable simultaneously by the **Generating Units** and/or **CCGT Modules** and/or **Power Park Modules** less the MW consumed by the **Generating Units** and/or **CCGT Modules** in producing that **Active Power**.
- (d) In the case of a **DC Converter** at a **DC Converter Station**, the normal full load amount of **Active Power** transferable from a **DC Converter** at the **Grid Entry Point** (or in the case of an **Embedded DC Converter Station** at the **User System Entry Point**), as declared by the **DC Converter Station** owner, expressed in whole MW.
- (e) In the case of a **DC Converter Station**, the maximum amount of **Active Power** transferable from a **DC Converter Station** at the **Grid Entry Point** (or in the case of an **Embedded DC Converter Station** at the **User System Entry Point**), as declared by the **DC Converter Station** owner, expressed in whole MW.

Registered Data

Those items of **Standard Planning Data** and **Detailed Planning Data** which upon connection become fixed (subject to any subsequent changes).

Registered Import Capability

In the case of a **DC Converter Station** containing **DC Converters** connected to an **External System**, the maximum amount of **Active Power** transferable into a **DC Converter Station** at the **Grid Entry Point** (or in the case of an **Embedded DC Converter Station** at the **User System Entry Point**), as declared by the **DC Converter Station** owner, expressed in whole MW.

In the case of a **DC Converter** connected to an **External System** and in a **DC Converter Station**, the normal full load amount of **Active Power** transferable into a **DC Converter** at the **Grid Entry Point** (or in the case of an **Embedded DC Converter Station** at the **User System Entry Point**), as declared by the **DC Converter** owner, expressed in whole MW.

<u>Regulations</u>	The Utilities Contracts Regulations 1996, as amended from time to time.
<u>Reheater Time Constant</u>	Determined at Registered Capacity , the reheater time constant will be construed in accordance with the principles of the IEEE Committee Report "Dynamic Models for Steam and Hydro Turbines in Power System Studies" published in 1973 which apply to such phrase.
<u>Relevant Transmission Licensee</u>	Means SP Transmission Ltd (SPT) in its Transmission Area and Scottish Hydro-Electric Transmission Ltd (SHETL) in its Transmission Area .
<u>Remote Transmission Assets</u>	Any Plant and Apparatus or meters owned by NGET which: <ul style="list-style-type: none"> a) are Embedded in a User System and which are not directly connected by Plant and/or Apparatus owned by NGET to a sub-station owned by NGET; and b) are by agreement between NGET and such User operated under the direction and control of such User.
<u>Requesting Safety Co-ordinator</u>	The Safety Co-ordinator requesting Safety Precautions .
<u>Responsible Engineer/Operator</u>	A person nominated by a User to be responsible for System control.
<u>Responsible Manager</u>	A manager who has been duly authorised by a User or NGET to sign Site Responsibility Schedules on behalf of that User or NGET , as the case may be. For Connection Sites in Scotland a manager who has been duly authorised by the Relevant Transmission Licensee to sign Site Responsibility Schedules on behalf of that Relevant Transmission Licensee .
<u>Re-synchronisation</u>	The bringing of parts of the Network Operator's User System which have become Out of Synchronism with each other back into Synchronism , and like terms shall be construed accordingly.
<u>Safety Co-ordinator</u>	A person or persons nominated by NGET and each User in relation to Connection Points in England and Wales and/or by the Relevant Transmission Licensee and each User in relation to Connection Points in Scotland to be responsible for the co-ordination of Safety Precautions at each Connection Point when work (which includes testing) is to be carried out on a System which necessitates the provision of Safety Precautions on HV Apparatus (as defined in OC8A.1.6.2 and OC8B.1.7.2), pursuant to OC8 .

<u>Safety From The System</u>	That condition which safeguards persons when work is to be carried out on or near a System from the dangers which are inherent in the System .
<u>Safety Key</u>	A key unique at the Location capable of operating a lock which will cause an Isolating Device and/or Earthing Device to be Locked .
<u>Safety Log</u>	A chronological record of messages relating to safety co-ordination sent and received by each Safety Co-ordinator under OC8 .
<u>Safety Precautions</u>	Isolation and/or Earthing .
<u>Safety Rules</u>	The rules of NGET (in England and Wales) and the Relevant Transmission Licensee (in Scotland) or a User that seek to ensure that persons working on Plant and/or Apparatus to which the rules apply are safeguarded from hazards arising from the System .
<u>Secondary Response</u>	The automatic increase in Active Power output of a Genset or, as the case may be, the decrease in Active Power Demand in response to a System Frequency fall. This increase in Active Power output or, as the case may be, the decrease in Active Power Demand must be in accordance with the provisions of the relevant Ancillary Services Agreement which will provide that it will be fully available by 30 seconds from the time of the start of the Frequency fall and be sustainable for at least a further 30 minutes. The interpretation of the Secondary Response to a -0.5 Hz frequency change is shown diagrammatically in Figure CC.A.3.2.
<u>Secretary of State</u>	Has the same meaning as in the Act .
<u>Secured Event</u>	Has the meaning set out in the Security and Quality of Supply Standard .
<u>Security and Quality of Supply Standard</u>	The version of the document entitled 'Security and Quality of Supply Standard' established pursuant to the Transmission Licence in force at the time of entering into the relevant Bilateral Agreement .
<u>Settlement Period</u>	A period of 30 minutes ending on the hour and half-hour in each hour during a day.
<u>Seven Year Statement</u>	A statement, prepared by NGET in accordance with the terms of NGET's Transmission Licence , showing for each of the seven succeeding Financial Years , the opportunities available for connecting to and using the GB Transmission System and indicating those parts of the GB Transmission System most suited to new connections and transport of further quantities of electricity.
<u>SF₆ Gas Zone</u>	A segregated zone surrounding electrical conductors within a casing containing SF ₆ gas.

SHETL

Scottish Hydro-Electric Transmission Limited

Shutdown

The condition of a **Generating Unit** where the generator rotor is at rest or on barring.

Significant Incident

An **Event** which either:

- a) was notified by a **User** to **NGET** under **OC7**, and which **NGET** considers has had or may have had a significant effect on the **GB Transmission System**, and **NGET** requires the **User** to report that **Event** in writing in accordance with **OC10** and notifies the **User** accordingly; or
- b) was notified by **NGET** to a **User** under **OC7**, and which that **User** considers has had or may have had a significant effect on that **User's System**, and that **User** requires **NGET** to report that **Event** in writing in accordance with the provisions of **OC10** and notifies **NGET** accordingly.

Simultaneous Tap Change

A tap change implemented on the generator step-up transformers of **Synchronised Gensets**, effected by **Generators** in response to an instruction from **NGET** issued simultaneously to the relevant **Power Stations**. The instruction, preceded by advance notice, must be effected as soon as possible, and in any event within one minute of receipt from **NGET** of the instruction.

Single Line Diagram

A schematic representation of a three-phase network in which the three phases are represented by single lines. The diagram shall include (but not necessarily be limited to) busbars, overhead lines, underground cables, power transformers and reactive compensation equipment. It shall also show where **Large Power Stations** are connected, and the points at which **Demand** is supplied.

Single Point of Connection

A single **Point of Connection**, with no interconnection through the **User's System** to another **Point of Connection**.

Site Common Drawings

Drawings prepared for each **Connection Site** which incorporate **Connection Site** layout drawings, electrical layout drawings, common protection/ control drawings and common services drawings.

Site Responsibility Schedule

A schedule containing the information and prepared on the basis of the provisions set out in Appendix 1 of the **CC**.

Slope

The ratio of the steady state change in voltage to the steady state change in **Reactive Power** output.

Small Power Station

A **Power Station** in **NGET's Transmission Area** with a **Registered Capacity** of less than 50MW or a **Power Station** in **SPT's** or **SHETL's Transmission Area** with a **Registered Capacity** of less than 5 MW.

<u>Speeder Motor Setting Range</u>	The minimum and maximum no-load speeds (expressed as a percentage of rated speed) to which the turbine is capable of being controlled, by the speeder motor or equivalent, when the Generating Unit terminals are on open circuit.
<u>SPT</u>	SP Transmission Limited
<u>Standard Planning Data</u>	The general data required by NGET under the PC . It is generally also the data which NGET requires from a new User in an application for a CUSC Contract , as reflected in the PC .
<u>Start Time</u>	The time named as such in an instruction issued by NGET pursuant to the BCs .
<u>Start-Up</u>	The action of bringing a Generating Unit from Shutdown to Synchronous Speed .
<u>Statement of Readiness</u>	Has the meaning set out in the Bilateral Agreement and/or Construction Agreement .
<u>Station Board</u>	A switchboard through which electrical power is supplied to the Auxiliaries of a Power Station , and which is supplied by a Station Transformer . It may be interconnected with a Unit Board .
<u>Station Transformer</u>	A transformer supplying electrical power to the Auxiliaries of <ul style="list-style-type: none"> • a Power Station, which is not directly connected to the Generating Unit terminals (typical voltage ratios being 132/11kV or 275/11kV), or • a DC Converter Station.
<u>STC Committee</u>	The committee established under the STC .
<u>Steam Unit</u>	A Generating Unit whose prime mover converts the heat-energy in steam to mechanical energy.
<u>Subtransmission System</u>	The part of a User's System which operates at a single transformation below the voltage of the relevant Transmission System .
<u>Supergrid Voltage</u>	Any voltage greater than 200kV.

Supplier

- (a) A person supplying electricity under an **Electricity Supply Licence**; or
 - (b) A person supplying electricity under exemption under the **Act**;
- in each case acting in its capacity as a supplier of electricity to **Customers** in **Great Britain**.

Surplus

A MW figure relating to a **System Zone** equal to the total **Output Usable** in the **System Zone**:

- a) minus the forecast of **Active Power Demand** in the **System Zone**, and
 - b) minus the export limit in the case of an export limited **System Zone**,
- or
- plus the import limit in the case of an import limited **System Zone**,
- and
- c) (only in the case of a **System Zone** comprising the **GB Transmission System**) minus the **Operational Planning Margin**.

For the avoidance of doubt, a **Surplus** of more than zero in an export limited **System Zone** indicates an excess of generation in that **System Zone**; and a **Surplus** of less than zero in an import limited **System Zone** indicates insufficient generation in that **System Zone**.

Synchronised

- a) The condition where an incoming **Generating Unit or Power Park Module or DC Converter or System** is connected to the busbars of another **System** so that the **Frequencies** and phase relationships of that **Generating Unit, Power Park Module, DC Converter or System**, as the case may be, and the **System** to which it is connected are identical, like terms shall be construed accordingly.
- b) The condition where an importing **BM Unit** is consuming electricity.

Synchronising Generation

The amount of MW (in whole MW) produced at the moment of synchronising.

Synchronising Group

A group of two or more **Gensets**) which require a minimum time interval between their **Synchronising** or **De-Synchronising** times.

Synchronous Compensation

The operation of rotating synchronous **Apparatus** for the specific purpose of either the generation or absorption of **Reactive Power**.

**Synchronous
Generating Unit**

A **Generating Unit** including, for the avoidance of doubt, a **CCGT Unit** in which, under all steady state conditions, the rotor rotates at a mechanical speed equal to the electrical frequency of the **GB Transmission System** divided by the number of pole pairs of the **Generating Unit** .

Synchronous Speed

That speed required by a **Generating Unit** to enable it to be **Synchronised** to a **System**.

System

Any **User System** and/or the **GB Transmission System**, as the case may be.

System Ancillary Services

Collectively **Part 1 System Ancillary Services** and **Part 2 System Ancillary Services**.

System Constraint

A limitation on the use of a **System** due to lack of transmission capacity or other **System** conditions.

System Constrained Capacity

That portion of **Registered Capacity** or **Registered Import Capacity** not available due to a **System Constraint**.

System Constraint Group

A part of the **GB Transmission System** which, because of **System Constraints**, is subject to limits of **Active Power** which can flow into or out of (as the case may be) that part.

System Fault Dependability Index or Dp

A measure of the ability of **Protection** to initiate successful tripping of circuit-breakers which are associated with a faulty item of **Apparatus**. It is calculated using the formula:

$$Dp = 1 - F_1/A$$

Where:

A = Total number of **System** faults

F₁ = Number of **System** faults where there was a failure to trip a circuit-breaker.

System Margin

The margin in any period between

- (a) the sum of Maximum Export Limits and
 - (b) forecast **Demand** and the **Operating Margin**,
- for that period.

System Negative Reserve Active Power Margin or System NRAPM

That margin of **Active Power** sufficient to allow the largest loss of **Load** at any time.

System Operator - Transmission Owner Code or STC

Has the meaning set out in **NGET's Transmission Licence**

System Tests

Tests which involve simulating conditions, or the controlled application of irregular, unusual or extreme conditions, on the **Total System**, or any part of the **Total System**, but which do not include commissioning or recommissioning tests or any other tests of a minor nature.

System to Demand Intertrip Scheme

An intertrip scheme which disconnects **Demand** when a **System** fault has arisen to prevent abnormal conditions occurring on the **System**.

System to Generator Operational Intertripping

A **Balancing Service** involving the initiation by a **System to Generator Operational Intertripping Scheme** of automatic tripping of the **User's** circuit breaker(s) resulting in the tripping of **BM Unit(s)** or (where relevant) **Generating Unit(s)** comprised in a **BM Unit** to prevent abnormal system conditions occurring, such as over voltage, overload, **System** instability, etc, after the tripping of other circuit-breakers following power **System** fault(s).

System to Generator Operational Intertripping Scheme

A **System to Generating Unit** or **System to CCGT Module Intertripping Scheme** forming a condition of connection and specified in Appendix F3 of the relevant **Bilateral Agreement**, being either a **Category 1 Intertripping Scheme**, **Category 2 Intertripping Scheme**, **Category 3 Intertripping Scheme** or **Category 4 Intertripping Scheme**.

System Zone

A region of the **GB Transmission System** within a described boundary or the whole of the **GB Transmission System**, as further provided for in OC2.2.4, and the term "**Zonal**" will be construed accordingly.

Target Frequency

That **Frequency** determined by **NGET**, in its reasonable opinion, as the desired operating **Frequency** of the **Total System**. This will normally be 50.00Hz plus or minus 0.05Hz, except in exceptional circumstances as determined by **NGET**, in its reasonable opinion when this may be 49.90 or 50.10Hz. An example of exceptional circumstances may be difficulties caused in operating the **System** during disputes affecting fuel supplies.

Technical Specification

In relation to **Plant** and/or **Apparatus**,

- a) the relevant **European Specification**; or
- b) if there is no relevant **European Specification**, other relevant standards which are in common use in the European Community.

<u>Test Co-ordinator</u>	A person who co-ordinates System Tests .
<u>Test Panel</u>	A panel, whose composition is detailed in OC12 , which is responsible, inter alia, for considering a proposed System Test , and submitting a Proposal Report and a Test Programme .
<u>Test Programme</u>	A programme submitted by the Test Panel to NGET , the Test Proposer , and each User identified by NGET under OC12.4.2.1, which states the switching sequence and proposed timings of the switching sequence, a list of those staff involved in carrying out the System Test (including those responsible for the site safety) and such other matters as the Test Panel deems appropriate.
<u>Test Proposer</u>	The person who submits a Proposal Notice .
<u>Total Shutdown</u>	The situation existing when all generation has ceased and there is no electricity supply from External Interconnections and, therefore, the Total System has shutdown with the result that it is not possible for the Total System to begin to function again without NGET's directions relating to a Black Start .
<u>Total System</u>	The GB Transmission System and all User Systems in Great Britain .
<u>Trading Point</u>	A commercial and, where so specified in the Grid Code , an operational interface between a User and NGET , which a User has notified to NGET .
<u>Transfer Date</u>	Such date as may be appointed by the Secretary of State by order under section 65 of the Act .
<u>Transmission</u>	Means, when used in conjunction with another term relating to equipment or a site, whether defined or not, that the associated term is to be read as being part of or directly associated with the GB Transmission System , and not of or with the User System .
<u>Transmission Area</u>	Has the meaning set out in the Transmission Licence of a Transmission Licensee .
<u>Transmission Entry Capacity</u>	Has the meaning set out in the CUSC .
<u>Transmission Licence</u>	A licence granted under Section 6(1)(b) of the Act .
<u>Transmission Licensee</u>	Means the holder for the time being of a Transmission Licence .

<u>Transmission Site</u>	In England and Wales, means a site owned (or occupied pursuant to a lease, licence or other agreement) by NGET in which there is a Connection Point . For the avoidance of doubt, a site owned by a User but occupied by NGET as aforesaid, is a Transmission Site .
	In Scotland, means a site owned (or occupied pursuant to a lease, licence or other agreement) by a Relevant Transmission Licensee in which there is a Connection Point . For the avoidance of doubt, a site owned by a User but occupied by the Relevant Transmission Licensee as aforesaid, is a Transmission Site .
<u>Transmission System</u>	Has the same meaning as the term "licensee's transmission system" in the Transmission Licence of a Transmission Licensee .
<u>Turbine Time Constant</u>	Determined at Registered Capacity , the turbine time constant will be construed in accordance with the principles of the IEEE Committee Report "Dynamic Models for Steam and Hydro Turbines in Power System Studies" published in 1973 which apply to such phrase.
<u>Two Shifting Limit</u>	The maximum number of times in any Operational Day that a Genset may De-Synchronise .
<u>Unbalanced Load</u>	The situation where the Load on each phase is not equal.
<u>Under-excitation Limiter</u>	Shall have the meaning ascribed to that term in IEC 34-16-1:1991 [equivalent to British Standard BS4999 Section 116.1 : 1992].
<u>Under Frequency Relay</u>	An electrical measuring relay intended to operate when its characteristic quantity (Frequency) reaches the relay settings by decrease in Frequency .
<u>Unit Board</u>	A switchboard through which electrical power is supplied to the Auxiliaries of a Generating Unit and which is supplied by a Unit Transformer . It may be interconnected with a Station Board .
<u>Unit Transformer</u>	A transformer directly connected to a Generating Unit's terminals, and which supplies power to the Auxiliaries of a Generating Unit . Typical voltage ratios are 23/11kV and 15/6.6Kv.
<u>Unit Load Controller Response Time Constant</u>	The time constant, expressed in units of seconds, of the power output increase which occurs in the Secondary Response timescale in response to a step change in System Frequency .
<u>User</u>	A term utilised in various sections of the Grid Code to refer to the persons using the GB Transmission System , as more particularly identified in each section of the Grid Code concerned. In the Preface and the General Conditions the term means any person to whom the Grid Code applies.

User Development

In the **PC** means either **User's Plant** and/or **Apparatus** to be connected to the **GB Transmission System**, or a **Modification** relating to a **User's Plant** and/or **Apparatus** already connected to the **GB Transmission System**, or a proposed new connection or **Modification** to the connection within the **User System**.

User Site

In England and Wales, a site owned (or occupied pursuant to a lease, licence or other agreement) by a **User** in which there is a **Connection Point**. For the avoidance of doubt, a site owned by **NGET** but occupied by a **User** as aforesaid, is a **User Site**.

In Scotland, a site owned (or occupied pursuant to a lease, licence or other agreement) by a **User** in which there is a **Connection Point**. For the avoidance of doubt, a site owned by a **Relevant Transmission Licensee** but occupied by a **User** as aforesaid, is a **User Site**.

User System

Any system owned or operated by a **User** comprising:-

- (a) **Generating Units**; and/or
- (b) Systems consisting (wholly or mainly) of electric lines used for the distribution of electricity from **Grid Supply Points** or **Generating Units** or other entry points to the point of delivery to **Customers**, or other **Users**;

and **Plant** and/or **Apparatus** connecting:-

- (c) The system as described above; or
- (d) **Non-Embedded Customers** equipment;

to the **GB Transmission System** or to the relevant other **User System**, as the case may be.

The **User System** includes any **Remote Transmission Assets** operated by such **User** or other person and any **Plant** and/or **Apparatus** and meters owned or operated by the **User** or other person in connection with the distribution of electricity but does not include any part of the **GB Transmission System**.

User System Entry Point

A point at which a **Generating Unit**, a **CCGT Module** or a **CCGT Unit** or a **Power Park Module** or a **DC Converter**, as the case may be, which is **Embedded** connects to the **User System**.

Water Time Constant

Bears the meaning ascribed to the term "Water inertia time" in **IEC308**.

Weekly ACS Conditions

Means that particular combination of weather elements that gives rise to a level of peak **Demand** within a week, taken to commence on a Monday and end on a Sunday, which has a particular chance of being exceeded as a result of weather variation alone. This particular chance is determined such that the combined probabilities of **Demand** in all weeks of the year exceeding the annual peak **Demand** under **Annual ACS Conditions** is 50%, and in the week of maximum risk the weekly peak **Demand** under **Weekly ACS Conditions** is equal to the annual peak **Demand** under **Annual ACS Conditions**.

Zonal System Security Requirements

That generation required, within the boundary circuits defining the **System Zone**, which when added to the secured transfer capability of the boundary circuits exactly matches the **Demand** within the **System Zone**.

A number of the terms listed above are defined in other documents, such as the **Balancing and Settlement Code** and the **Transmission Licence**. Appendix 1 sets out the current definitions from the other documents of those terms so used in the **Grid Code** and defined in other documents for ease of reference, but does not form part of the **Grid Code**.

2. Construction of References

In the **Grid Code**:

- (i) a table of contents, a Preface, a Revision section, headings, and the Appendix to this **Glossary and Definitions** are inserted for convenience only and shall be ignored in construing the **Grid Code**;
- (ii) unless the context otherwise requires, all references to a particular paragraph, subparagraph, Appendix or Schedule shall be a reference to that paragraph, subparagraph Appendix or Schedule in or to that part of the **Grid Code** in which the reference is made;
- (iii) unless the context otherwise requires, the singular shall include the plural and vice versa, references to any gender shall include all other genders and references to persons shall include any individual, body corporate, corporation, joint venture, trust, unincorporated association, organisation, firm or partnership and any other entity, in each case whether or not having a separate legal personality;
- (iv) references to the words "include" or "including" are to be construed without limitation to the generality of the preceding words;
- (v) unless there is something in the subject matter or the context which is inconsistent therewith, any reference to an Act of Parliament or any Section of or Schedule to, or other provision of an Act of Parliament shall be construed at the particular time, as including a reference to any modification, extension or re-enactment thereof then in force and to all instruments, orders and regulations then in force and made under or deriving validity from the relevant Act of Parliament;
- (vi) where the **Glossary and Definitions** refers to any word or term which is more particularly defined in a part of the **Grid Code**, the definition in that part of the **Grid Code** will prevail (unless otherwise stated) over the definition in the **Glossary & Definitions** in the event of any inconsistency;
- (vii) a cross-reference to another document or part of the **Grid Code** shall not of itself impose any additional or further or co-existent obligation or confer any additional or further or co-existent right in the part of the text where such cross-reference is contained;
- (viii) nothing in the **Grid Code** is intended to or shall derogate from **NGET's** statutory or licence obligations;
- (ix) a "holding company" means, in relation to any person, a holding company of such person within the meaning of section 736, 736A and 736B of the Companies Act 1985 as substituted by section 144 of the Companies Act 1989 and, if that latter section is not in force at the **Transfer Date**, as if such latter section were in force at such date;
- (x) a "subsidiary" means, in relation to any person, a subsidiary of such person within the meaning of section 736, 736A and 736B of the Companies Act 1985 as substituted by section 144 of the Companies Act 1989 and, if that latter section is not in force at the **Transfer Date**, as if such latter section were in force at such date;
- (xi) references to time are to London time; and

- (xii) Where there is a reference to an item of data being expressed in a whole number of MW, fractions of a MW below 0.5 shall be rounded down to the nearest whole MW and fractions of a MW of 0.5 and above shall be rounded up to the nearest whole MW.

< End of GD >

APPENDIX 1

TERMS DEFINED IN OTHER DOCUMENTS

(This Appendix does not form part of the Grid Code)

The definitions detailed below are based on:

- The BSC Section X – V2.0 - 11th May 2001
- The Transmission Licence (TL) – September 2004
- Engineering Recommendation G5/4 - February 2001

Term	Defined in	Definition
Balancing Mechanism	TL	Means the mechanism for the making and acceptance of offers and bids pursuant to the arrangements contained in the BSC and referred to in paragraph 2(a) of standard condition C3 (Balancing and Settlement Code).
Balancing Mechanism Reporting Agent	BSC	Means the BSC Agent for Balancing Mechanism Reporting in accordance with Section E.
Balancing Mechanism Reporting Service	BSC	Means the service provided by the BMRA in accordance with Section V.
Bid-Offer Data	BSC	Data (comprising the items set out in Section Q4.1.3) to be submitted by the Transmission Company pursuant to Section Q6.2.1(d).
Bilateral Agreement	TL	Means a Bilateral Connection Agreement and/or a Bilateral Embedded Generation Agreement.
Bilateral Connection Agreement	TL	Means an agreement between the Licensee and a CUSC User supplemental to the CUSC relating to a direct connection to the GB Transmission System identifying the relevant connection site and setting out other site specific details in relation to that connection to the GB Transmission System, including provisions relating to payment of Connection Charges.
Bilateral Embedded Generation Agreement	TL	Means an agreement entered into between the Licensee and a CUSC User supplemental to the CUSC, relating to a generating station connected to a Distribution System and the use of the GB Transmission System in relation to that generating station identifying the relevant site of connection to the Distribution System and setting out other site specific details in relation to that use of the GB Transmission System.
BM Unit	BSC	Means a unit established and registered (or to be established and registered) by a Party in accordance with Section K3 or, where the context so requires, the Plant and/or Apparatus treated as comprised in or assigned to such unit for the purposes of the Code.
BSCCo	BSC	Means Elexon Limited (or any successor to that company acting in the capacity as BSCCo).

Term	Defined in	Definition
Construction Agreement	TL	Means an agreement between the Licensee and a CUSC User in respect of construction works required on the GB Transmission System and the associated construction works of the CUSC User in relation to a connection to the GB Transmission System or in relation to a generating station connected to a Distribution System, whether for the initial connection or a modification of the connection.
CUSC	TL	Means the Connection and Use of System Code provided for in paragraph 2 of standard condition C10 (Connection and Use of System Code), as from time to time modified in accordance with that condition.
CUSC Framework Agreement	TL	Means the agreement of that title, in the form approved by the Secretary of State, by which the CUSC is made contractually binding between the parties to that agreement, as amended from time to time with the approval of the Secretary of State.
Demand Capacity	BSC	Has the meaning given to that term in Section K3.4.8.
Electromagnetic Compatibility Level	ER G5/4	The specified disturbance level in a system which is expected to be exceeded only with small probability, this level being such that electromagnetic compatibility should exist for most equipment within the system.
Final Physical Notification Data	BSC	Means, in respect of a Settlement Period and a BM Unit, the data which is referred to in Section Q3.2.2 and which complies with the requirements of Section Q3.2.3.
Gate Closure	BSC	Means, in relation to a Settlement Period, the spot time 1 hour before the spot time at the start of that Settlement Period.
Generation Capacity	BSC	Has the meaning given to that term in Section K3.4.8.
Interconnector User	BSC	Means, in relation to an Interconnector, a Lead Party in respect of an Interconnector BM Unit other than the Interconnector Error Administrator.
Joint BM Unit Data	BSC	Means, in relation to a Joint BM Unit, the Teleswitch Group(s) and the teleswitched Standard Settlement Configuration(s) registered by a Supplier in relation to that BM Unit in accordance with Section K3.3.9.
Panel	BSC	Means the panel established pursuant to Section B1.1.1.

PLANNING CODE

CONTENTS

(This contents page does not form part of the Grid Code)

<u>Paragraph No/Title</u>	<u>Page Number</u>
PC.1 INTRODUCTION.....	1
PC.2 OBJECTIVE	2
PC.3 SCOPE	2
PC.4 PLANNING PROCEDURES	3
PC.4.2 Introduction to Data	4
PC.4.3 Data Provision	5
PC.4.4 Offer of Terms for connection	5
PC.4.5 Complex Connections	6
PC.5 PLANNING DATA	6
PC.6 PLANNING STANDARDS.....	9
APPENDIX A - PLANNING DATA REQUIREMENTS.....	10
PC.A.1 INTRODUCTION	10
PART 1 – STANDARD PLANNING DATA	14
PC.A.2 USER'S SYSTEM DATA	14
PC.A.2.1 Introduction	14
PC.A.2.2 User's System Layout	14
PC.A.2.3 Lumped System Susceptance	17
PC.A.2.4 Reactive Compensation Equipment	17
PC.A.2.5 Short Circuit Contribution to GB Transmission System	18
PC.A.3 GENERATING UNIT AND DC CONVERTER DATA.....	22
PC.A.3.1 Introduction	22
PC.A.3.2 Output Data	23
PC.A.3.3 Rated Parameters Data	27
PC.A.3.4 General Generating Unit, Power Park Module and DC Converter Data	28
PC.A.4 DEMAND AND ACTIVE ENERGY DATA	29
PC.A.4.1 Introduction	29

PC.A.4.2 Demand (Active Power) and Active Energy Data	29
PC.A.4.3 Connection Point Demand (Active and Reactive Power)	31
PC.A.4.5 Demand Transfer Capability	32
PC.A.4.6 Control of Demand or Reduction of Pumping Load Offered as Reserve	33
PC.A.4.7 General Demand Data	33
PART 2 – DETAILED PLANNING DATA	34
PC.A.5 GENERATING UNIT POWER PARK MODULE AND DC CONVERTER DATA.....	34
PC.A.5.1 Introduction	34
PC.A.5.2 Demand	35
PC.A.5.3 Synchronous Generating Unit and Associated Control System Data	35
PC.A.5.4 Non-Synchronous Generating Unit and Associated Control System Data	41
PC.A.5.5 Response data for Frequency changes	47
PC.A.5.6 Mothballed Generating Unit and Alternative Fuel Information	48
PC.A.6 USERS' SYSTEM DATA.....	49
PC.A.6.1 Introduction	49
PC.A.6.2 Transient Overvoltage Assessment Data	50
PC.A.6.3 User's Protection Data	50
PC.A.6.4 Harmonic Studies	51
PC.A.6.5 Voltage Assessment Studies	52
PC.A.6.6 Short Circuit Analysis	53
PC.A.7 ADDITIONAL DATA FOR NEW TYPES OF POWER STATIONS, DC CONVERTER STATIONS AND CONFIGURATIONS	53
PART 3 – NETWORK DATA	55
PC.A.8.1 Single Point of Connection	55
PC.A.8.2 Multiple Point of Connection	55
PC.A.8.3 Data Items	55
APPENDIX B.....	58
Single Line Diagrams	58
 APPENDIX C	
 PART 1 – SSE's TECHNICAL AND DESIGN CRITERIA	
PART 2 – SPT's TECHNICAL AND DESIGN CRITERIA	

PLANNING CODE

PC.1 INTRODUCTION

PC.1.1 The **Planning Code** ("PC") specifies the technical and design criteria and procedures to be applied by **NGET** in the planning and development of the **GB Transmission System** and to be taken into account by **Users** in the planning and development of their own **Systems**. It details information to be supplied by **Users** to **NGET**, and certain information to be supplied by **NGET** to **Users**. In Scotland, **NGET** has obligations under the **STC** to inform **Relevant Transmission Licensees** of data required for the planning of the **GB Transmission System**. **NGET** may pass on **User** data to a **Relevant Transmission Licensee** where **NGET** is required to do so under a provision of the **STC** current as at 1 April 2005. Those categories of **User** information that **NGET** is permitted to disclose to a **Relevant Transmission Licensee**, where required to do so by a provision of the **STC**, are set out in Schedule Three of the **STC** ('Information and data exchange specification').

PC.1.2 The **Users** referred to above are defined, for the purpose of the **PC**, in PC.3.1.

PC.1.3 Development of the **GB Transmission System**, involving its reinforcement or extension, will arise for a number of reasons including, but not limited to:

- (a) a development on a **User System** already connected to the **GB Transmission System**;
- (b) the introduction of a new **Connection Site** or the **Modification** of an existing **Connection Site** between a **User System** and the **GB Transmission System**;
- (c) the cumulative effect of a number of such developments referred to in (a) and (b) by one or more **Users**.

PC.1.4 Accordingly, the reinforcement or extension of the **GB Transmission System** may involve work:

- (a) at a substation at a **Connection Site** where **User's Plant** and/or **Apparatus** is connected to the **GB Transmission System**;
- (b) on transmission lines or other facilities which join that **Connection Site** to the remainder of the **GB Transmission System**;
- (c) on transmission lines or other facilities at or between points remote from that **Connection Site**.

PC.1.5 The time required for the planning and development of the **GB Transmission System** will depend on the type and extent of the necessary reinforcement and/or extension work, the need or otherwise for statutory planning consent, the associated possibility of the need for a public inquiry and the degree of complexity in undertaking the new work while maintaining satisfactory security and quality of supply on the existing **GB Transmission System**.

PC.2 OBJECTIVE

PC.2.1 The objectives of the **PC** are:

- (a) to promote **NGET/User** interaction in respect of any proposed development on the **User System** which may impact on the performance of the **GB Transmission System** or the direct connection with the **GB Transmission System**;
- (b) to provide for the supply of information to **NGET** from **Users** in order that planning and development of the **GB Transmission System** can be undertaken in accordance with the relevant **Licence Standards**, to facilitate existing and proposed connections, and also to provide for the supply of certain information from **NGET** to **Users** in relation to short circuit current contributions; and
- (c) to specify the **Licence Standards** which will be used in the planning and development of the **GB Transmission System**; and
- (d) to provide for the supply of information required by **NGET** from **Users** in respect of the following to enable **NGET** to carry out its duties under the **Act** and the **Transmission Licence**:
 - (i) **Mothballed Generating Units**; and
 - (ii) capability of gas-fired **Generating Units** to run using alternative fuels.

NGET will use the information provided under PC2.1(d) in providing reports to the **Authority** and the **Secretary of State** and, where directed by the **Authority** or the **Secretary of State** to do so, **NGET** may publish the information. Where it is known by **NGET** that such information is intended for wider publication the information provided under PC2.1(d) shall be aggregated such that individual data items should not be identifiable.

PC.3 SCOPE

PC.3.1 The **PC** applies to **NGET** and to **Users**, which in the **PC** means:

- (a) **Generators**;
- (b) **Network Operators**;
- (c) **Non-Embedded Customers**; and
- (d) **DC Converter Station** owners.

The above categories of **User** will become bound by the **PC** prior to them generating, operating, or consuming or importing/exporting, as the case may be, and references to the various categories (or to the general category) of

User should, therefore, be taken as referring to them in that prospective role as well as to **Users** actually connected.

PC.3.2

In the case of **Embedded Power Stations** and **Embedded DC Converters**, unless provided otherwise, the following provisions apply with regard to the provision of data under this **PC**:

- (a) each **Generator** shall provide the data direct to **NGET** in respect of (i) **Embedded Large Power Stations**, (ii) **Embedded Medium Power Stations** and (iii) **Embedded Small Power Stations** which form part of a **Cascade Hydro Scheme**;
- (b) each **DC Converter** owner shall provide the data direct to **NGET** in respect of **Embedded DC Converter Stations**;
- (c) although data is not normally required specifically on **Embedded Small Power Stations** or on **Embedded** installations of direct current converters which do not form a **DC Converter Station** under this **PC**, each **Network Operator** in whose **System** they are **Embedded** should provide the data (contained in the Appendix) to **NGET** in respect of **Embedded Small Power Stations** or **Embedded** installations of direct current converters which do not form a **DC Converter Station** if:
 - (i) it falls to be supplied pursuant to the application for a **CUSC Contract** or in the **Statement of Readiness** to be supplied in connection with a **Bilateral Agreement** and/or **Construction Agreement**, by the **Network Operator**; or
 - (ii) it is specifically requested by **NGET** in the circumstances provided for under this **PC**.

PC.3.3

Certain data does not normally need to be provided in respect of certain **Embedded Power Stations** or **Embedded DC Converter Stations**, as provided in PC.A.1.12.

PC.4

PLANNING PROCEDURES

PC.4.1

Pursuant to Condition C11 of **NGET's Transmission Licence**, the means by which **Users** and proposed **Users** of the **GB Transmission System** are able to assess opportunities for connecting to, and using, the **GB Transmission System** comprise two distinct parts, namely:

- (a) a statement, prepared by **NGET** under its **Transmission Licence**, showing for each of the seven succeeding **Financial Years**, the opportunities available for connecting to and using the **GB Transmission System** and indicating those parts of the **GB Transmission System** most suited to new connections and transport of further quantities of electricity (the "**Seven Year Statement**"); and
- (b) an offer, in accordance with its **Transmission Licence**, by **NGET** to enter into a **CUSC Contract** for connection to (or, in the case of

Embedded Large Power Stations, Embedded Medium Power Stations and Embedded DC Converter Stations, use of) the **GB Transmission System**. A **Bilateral Agreement** is to be entered into for every **Connection Site** (and for certain **Embedded Power Stations** and **Embedded DC Converter Stations**, as explained above) within the first two of the following categories and the existing **Bilateral Agreement** may be required to be varied in the case of the third category:

- (i) existing **Connection Sites** (and for certain **Embedded Power Stations**, as detailed above) as at the **Transfer Date**;
- (ii) new **Connection Sites** (and for certain **Embedded Power Stations** and for **Embedded DC Converter Stations**, as detailed above) with effect from the **Transfer Date**;
- (iii) a **Modification** at a **Connection Site** (or in relation to the connection of certain **Embedded Power Stations** and for **Embedded DC Converter Stations**, as detailed above) (whether such **Connection Site** or connection exist on the **Transfer Date** or are new thereafter) with effect from the **Transfer Date**.

In this **PC**, unless the context otherwise requires, "connection" means any of these 3 categories.

PC.4.2 Introduction to Data

User Data

PC.4.2.1 Under the **PC**, two types of data to be supplied by **Users** are called for:

- (a) **Standard Planning Data**; and
- (b) **Detailed Planning Data**,

as more particularly provided in PC.A.1.4.

PC.4.2.2 The **PC** recognises that these two types of data, namely **Standard Planning Data** and **Detailed Planning Data**, are considered at three different levels:

- (a) **Preliminary Project Planning Data**;
- (b) **Committed Project Planning Data**; and
- (c) **Connected Planning Data**,

as more particularly provided in **PC.5**

PC.4.2.3 **Connected Planning Data** is itself divided into:

- (a) **Forecast Data**;
- (b) **Registered Data**; and

(c) **Estimated Registered Data,**

as more particularly provided in PC.5.5

PC.4.2.4 Clearly, an existing **User** proposing a new **Connection Site** (or **Embedded Power Station** or **Embedded DC Converter Station** in the circumstances outlined in PC.4.1) will need to supply data both in an application for a **Bilateral Agreement** and under the **PC** in relation to that proposed new **Connection Site** (or **Embedded Power Station** or **Embedded DC Converter Station** in the circumstances outlined in PC.4.1) and that will be treated as **Preliminary Project Planning Data** or **Committed Project Planning Data** (as the case may be), but the data it supplies under the **PC** relating to its existing **Connection Sites** will be treated as **Connected Planning Data**.

Network Data

PC.4.2.5 In addition, there is **Network Data** supplied by **NGET** in relation to short circuit current contributions.

PC.4.3 Data Provision

PC.4.3.1 Seven Year Statement

To enable the **Seven Year Statement** to be prepared, each **User** is required to submit to **NGET** (subject to the provisions relating to **Embedded Power Stations** and **Embedded DC Converter Stations** in PC.3.2) both the **Standard Planning Data** and the **Detailed Planning Data** as listed in parts 1 and 2 of the Appendix. This data should be submitted in calendar week 24 of each year (although **Network Operators** may delay the submission until calendar week 28) and should cover each of the seven succeeding **Financial Years** (and in certain instances, the current year). Where, from the date of one submission to another, there is no change in the data (or in some of the data) to be submitted, instead of re-submitting the data, a **User** may submit a written statement that there has been no change from the data (or in some of the data) submitted the previous time. In addition, **NGET** will also use the **Transmission Entry Capacity** and **Connection Entry Capacity** data from the **CUSC Contract** in the preparation of the **Seven Year Statement** and to that extent the data will not be treated as confidential.

PC.4.3.2 Network Data

To enable **Users** to model the **GB Transmission System** in relation to short circuit current contributions, **NGET** is required to submit to **Users** the **Network Data** as listed in Part 3 of the Appendix. The data will be submitted in week 42 of each year and will cover that **Financial Year**.

PC.4.4 Offer of Terms for connection

PC.4.4.1 The completed application form for a **CUSC Contract** to be submitted by a **User** when making an application for a **CUSC Contract** will include:

- (a) a description of the **Plant** and/or **Apparatus** to be connected to the **GB Transmission System** or of the **Modification** relating to the **User's Plant** and/or **Apparatus** already connected to the **GB Transmission System** or, as the case may be, of the proposed new

connection or **Modification** to the connection within the **User System** of the **User**, each of which shall be termed a "**User Development**" in the **PC**;

- (b) the relevant **Standard Planning Data** as listed in Part 1 of the Appendix; and
- (c) the desired **Completion Date** of the proposed **User Development**.
- (d) the desired **Connection Entry Capacity** and **Transmission Entry Capacity**.

The completed application form for a **CUSC Contract** will be sent to **NGET** as more particularly provided in the application form.

PC.4.4.2 Any offer of a **CUSC Contract** will provide that it must be accepted by the applicant **User** within the period stated in the offer, after which the offer automatically lapses. Acceptance of the offer renders the **GB Transmission System** works relating to that **User Development**, reflected in the offer, committed and binds both parties to the terms of the offer. Within 28 days (or such longer period as **NGET** may agree in any particular case) of acceptance of the offer the **User** shall supply the **Detailed Planning Data** pertaining to the **User Development** as listed in Part 2 of the Appendix.

PC.4.5 Complex connections

PC.4.5.1 The magnitude and complexity of any **GB Transmission System** extension or reinforcement will vary according to the nature, location and timing of the proposed **User Development** which is the subject of the application and it may, in the event, be necessary for **NGET** to carry out additional more extensive system studies to evaluate more fully the impact of the proposed **User Development** on the **GB Transmission System**. Where **NGET** judges that such additional more detailed studies are necessary the offer may indicate the areas that require more detailed analysis and before such additional studies are required, the **User** shall indicate whether it wishes **NGET** to undertake the work necessary to proceed to make a revised offer within the 3 month period normally allowed or, where relevant, the timescale consented to by the **Authority**.

PC.4.5.2 To enable **NGET** to carry out any of the above mentioned necessary detailed system studies, the **User** may, at the request of **NGET**, be required to provide some or all of the **Detailed Planning Data** listed in part 2 of the Appendix in advance of the normal timescale referred in PC.4.4.2 provided that **NGET** can reasonably demonstrate that it is relevant and necessary.

PC.5 PLANNING DATA

PC.5.1 As far as the **PC** is concerned, there are three relevant levels of data in relation to **Users**. These levels, which relate to levels of confidentiality, commitment and validation, are described in the following paragraphs.

Preliminary Project Planning Data

PC.5.2 At the time the **User** applies for a **CUSC Contract** but before an offer is made and accepted by the applicant **User**, the data relating to the proposed **User Development** will be considered as **Preliminary Project Planning Data**. This data will be treated as confidential within the scope of the provisions relating to confidentiality in the **CUSC**.

PC.5.3 **Preliminary Project Planning Data** will normally only contain the **Standard Planning Data** unless the **Detailed Planning Data** is required in advance of the normal timescale to enable **NGET** to carry out additional detailed system studies as described in PC.4.5.

Committed Project Planning Data

PC.5.4 Once the offer for a **CUSC Contract** is accepted, the data relating to the **User Development** already submitted as **Preliminary Project Planning Data**, and subsequent data required by **NGET** under this **PC**, will become **Committed Project Planning Data**. This data, together with **Connection Entry Capacity** and **Transmission Entry Capacity** data from the **CUSC Contract** and other data held by **NGET** relating to the **GB Transmission System** will form the background against which new applications by any **User** will be considered and against which planning of the **GB Transmission System** will be undertaken. Accordingly, **Committed Project Planning Data**, **Connection Entry Capacity** and **Transmission Entry Capacity** data will not be treated as confidential to the extent that **NGET**:

- (a) is obliged to use it in the preparation of the **Seven Year Statement** and in any further information given pursuant to the **Seven Year Statement**;
- (b) is obliged to use it when considering and/or advising on applications (or possible applications) of other **Users** (including making use of it by giving data from it, both orally and in writing, to other **Users** making an application (or considering or discussing a possible application) which is, in **NGET's** view, relevant to that other application or possible application);
- (c) is obliged to use it for operational planning purposes;
- (d) is obliged under the terms of an **Interconnection Agreement** to pass it on as part of system information on the **Total System**.
- (e) is obliged to disclose it under **STC**.

To reflect different types of data, **Preliminary Project Planning Data** and **Committed Project Planning Data** are themselves divided into:

- (a) those items of **Standard Planning Data** and **Detailed Planning Data** which will always be forecast, known as **Forecast Data**; and

- (b) those items of **Standard Planning Data** and **Detailed Planning Data** which relate to **Plant** and/or **Apparatus** which upon connection will become **Registered Data**, but which prior to connection, for the seven succeeding **Financial Years**, will be an estimate of what is expected, known as **Estimated Registered Data**.

Connected Planning Data

PC.5.5

The **PC** requires that, at the time that a **Statement of Readiness** is submitted under the **Bilateral Agreement** and/or **Construction Agreement**, any estimated values assumed for planning purposes are confirmed or, where practical, replaced by validated actual values and by updated estimates for the future and by updated forecasts for forecast data items such as **Demand**. This data is then termed **Connected Planning Data**.

To reflect the three types of data referred to above, **Connected Planning Data** is itself divided into:

- (a) those items of **Standard Planning Data** and **Detailed Planning Data** which will always be forecast data, known as **Forecast Data**; and
- (b) those items of **Standard Planning Data** and **Detailed Planning Data** which upon connection become fixed (subject to any subsequent changes), known as **Registered Data**; and
- (c) those items of **Standard Planning Data** and **Detailed Planning Data** which for the purposes of the **Plant** and/or **Apparatus** concerned as at the date of submission are **Registered Data** but which for the seven succeeding **Financial Years** will be an estimate of what is expected, known as **Estimated Registered Data**,

as more particularly provided in the Appendix.

PC.5.6

Connected Planning Data, together with **Connection Entry Capacity** and **Transmission Entry Capacity** data from the **CUSC Contract**, and other data held by **NGET** relating to the **GB Transmission System**, will form the background against which new applications by any **User** will be considered and against which planning of the **GB Transmission System** will be undertaken. Accordingly, **Connected Planning Data**, **Connection Entry Capacity** and **Transmission Entry Capacity** data will not be treated as confidential to the extent that **NGET**:

- (a) is obliged to use it in the preparation of the **Seven Year Statement** and in any further information given pursuant to the **Seven Year Statement**;
- (b) is obliged to use it when considering and/or advising on applications (or possible applications) of other **Users** (including making use of it by giving data from it, both orally and in writing, to other **Users** making an application (or considering or discussing a possible application) which is, in **NGET's** view, relevant to that other application or possible application);

- (c) is obliged to use it for operational planning purposes;
- (d) is obliged under the terms of an **Interconnection Agreement** to pass it on as part of system information on the **Total System**.
- (e) is obliged to disclose it under the **STC**.

PC.5.7 **Committed Project Planning Data** and **Connected Planning Data** will each contain both **Standard Planning Data** and **Detailed Planning Data**.

PC.6 PLANNING STANDARDS

PC.6.1 **NGET** shall apply the **Licence Standards** relevant to planning and development, in the planning and development of its **Transmission System**. **NGET** shall procure that each **Relevant Transmission Licensee** shall apply the **Licence Standards** relevant to planning and development, in the planning and development of the **Transmission System** of each **Relevant Transmission Licensee**.

PC.6.2 In relation to Scotland, Appendix C lists the technical and design criteria applied in the planning and development of each **Relevant Transmission Licensee's Transmission System**. The criteria are subject to review in accordance with each **Relevant Transmission Licensee's Transmission Licence** conditions. Copies of these documents are available from **NGET** on request. **NGET** will charge an amount sufficient to recover its reasonable costs incurred in providing this service.

APPENDIX A

PLANNING DATA REQUIREMENTS

PC.A.1. INTRODUCTION

PC.A.1.1 The Appendix specifies data requirements to be submitted to **NGET** by **Users**, and in certain circumstances to **Users** by **NGET**.

Submissions by Users

- PC.A.1.2 (a) Planning data submissions by **Users** shall be:
- (i) with respect to each of the seven succeeding **Financial Years** (other than in the case of **Registered Data** which will reflect the current position and data relating to **Demand** forecasts which relates also to the current year);
 - (ii) provided by **Users** in connection with a **CUSC Contract** (PC.4.1, PC.4.4 and PC.4.5 refer); and
 - (iii) provided by **Users** on a routine annual basis in calendar week 24 of each year to maintain an up-to-date data bank (although **Network Operators** may delay the submission until calendar week 28). Where from the date of one annual submission to another there is no change in the data (or in some of the data) to be submitted, instead of re-submitting the data, a **User** may submit a written statement that there has been no change from the data (or some of the data) submitted the previous time.
- (b) Where there is any change (or anticipated change) in **Committed Project Planning Data** or a significant change in **Connected Planning Data** in the category of **Forecast Data** or any change (or anticipated change) in **Connected Planning Data** in the categories of **Registered Data** or **Estimated Registered Data** supplied to **NGET** under the **PC**, notwithstanding that the change may subsequently be notified to **NGET** under the **PC** as part of the routine annual update of data (or that the change may be a **Modification** under the **CUSC**), the **User** shall, subject to PC.A.3.2.3 and PC.A.3.2.4, notify **NGET** in writing without delay.
- (c) The notification of the change will be in the form required under this **PC** in relation to the supply of that data and will also contain the following information:
- (i) the time and date at which the change became, or is expected to become, effective;
 - (ii) if the change is only temporary, an estimate of the time and date at which the data will revert to the previous registered form.
- (d) The routine annual update of data, referred to in (a)(iii) above, need not be submitted in respect of **Small Power Stations** or **Embedded**

installations of direct current converters which do not form a **DC Converter Station** (except as provided in PC.3.2.(c)), or unless specifically requested by **NGET**, or unless otherwise specifically provided.

PC.A.1.3

Submissions by **NGET**

Network Data release by **NGET** shall be:

- (a) with respect to the current **Financial Year**;
- (b) provided by **NGET** on a routine annual basis in calendar week 42 of each year. Where from the date of one annual submission to another there is no change in the data (or in some of the data) to be released, instead of repeating the data, **NGET** may release a written statement that there has been no change from the data (or some of the data) released the previous time.

The three parts of the Appendix

PC.A.1.4

The data requirements listed in this Appendix are subdivided into the following three parts:

(a) **Standard Planning Data**

This data (as listed in Part 1 of the Appendix) is first to be provided by a **User** at the time of an application for a **CUSC Contract**. It comprises data which is expected normally to be sufficient for **NGET** to investigate the impact on the **GB Transmission System** of any **User Development** associated with an application by the **User** for a **CUSC Contract**. **Users** should note that the term **Standard Planning Data** also includes the information referred to in PC.4.4.1.(a).

(b) **Detailed Planning Data**

This data (as listed in Part 2 of the Appendix) is usually first to be provided by the **User** within 28 days (or such longer period as **NGET** may agree in any particular case) of the offer for a **CUSC Contract**, being accepted by the **User**. It comprises additional, more detailed, data not normally expected to be required by **NGET** to investigate the impact on the **GB Transmission System** of any **User Development** associated with an application by the **User** for a **CUSC Contract**. **Users** should note that, although not needed within 28 days of the offer, the term **Detailed Planning Data** also includes **Operation Diagrams** and **Site Common Drawings** produced in accordance with the **CC**.

The **User** may, however, be required by **NGET** to provide the **Detailed Planning Data** in advance of the normal timescale before **NGET** can make an offer for a **CUSC Contract**, as explained in PC.4.5.

(c) **Network Data**

The data requirements for **NGET** in this Appendix are in Part 3.

Forecast Data, Registered Data and Estimated Registered Data

PC.A.1.5

As explained in PC.5.4 and PC.5.5, **Planning Data** is divided into:

- (i) those items of **Standard Planning Data** and **Detailed Planning Data** known as **Forecast Data**; and
- (ii) those items of **Standard Planning Data** and **Detailed Planning Data** known as **Registered Data**; and
- (iii) those items of **Standard Planning Data** and **Detailed Planning Data** known as **Estimated Registered Data**.

PC.A.1.6

The following paragraphs in this Appendix relate to **Forecast Data**:

3.2.2(b), (h), (i) and (j)
4.2.1
4.3.1
4.3.2
4.3.3
4.3.4
4.3.5
4.5(a)(ii) and (b)(ii)
4.7.1
5.2.1
5.2.2
5.6.1

PC.A.1.7

The following paragraphs in this Appendix relate to **Registered Data** and **Estimated Registered Data**:

2.2.1
2.2.4
2.2.5
2.2.6
2.3.1
2.4.1
2.4.2
3.2.2(a), (c), (d), (e), (f), (g), (i)(part) and (j)
3.4.1
3.4.2
4.2.3
4.5(a)(i), (a)(iii), (b)(i) and (b)(iii)
4.6
5.3.2
5.4
5.4.2
5.4.3
5.5
5.6.3
6.2
6.3

- PC.A.1.8 The data supplied under PC.A.3.3.1, although in the nature of **Registered Data**, is only supplied upon application for a **CUSC Contract**, and therefore does not fall to be **Registered Data**, but is **Estimated Registered Data**.
- PC.A.1.9 **Forecast Data** must contain the **User's** best forecast of the data being forecast, acting as a reasonable and prudent **User** in all the circumstances.
- PC.A.1.10 **Registered Data** must contain validated actual values, parameters or other information (as the case may be) which replace the estimated values, parameters or other information (as the case may be) which were given in relation to those data items when they were **Preliminary Project Planning Data** and **Committed Project Planning Data**, or in the case of changes, which replace earlier actual values, parameters or other information (as the case may be). Until amended pursuant to the **Grid Code**, these actual values, parameters or other information (as the case may be) will be the basis upon which the **GB Transmission System** is planned, designed, built and operated in accordance with, amongst other things, the **Transmission Licences**, the **STC** and the **Grid Code**, and on which **NGET** therefore relies. In following the processes set out in the **BCs**, **NGET** will use the data which has been supplied to it under the **BCs** and the data supplied under **OC2** in relation to **Gensets**, but the provision of such data will not alter the data supplied by **Users** under the **PC**, which may only be amended as provided in the **PC**.
- PC.A.1.11 **Estimated Registered Data** must contain the **User's** best estimate of the values, parameters or other information (as the case may be), acting as a reasonable and prudent **User** in all the circumstances.
- PC.A.1.12 Certain data does not need to be supplied in relation to **Embedded Power Stations** or **Embedded DC Converter Stations** where these are connected at a voltage level below the voltage level directly connected to the **GB Transmission System** except in connection with a **CUSC Contract**, or unless specifically requested by **NGET**.

PART 1
STANDARD PLANNING DATA

PC.A.2 USER'S SYSTEM DATA

PC.A.2.1 Introduction

PC.A.2.1.1 Each **User**, whether connected directly via an existing **Connection Point** to the **GB Transmission System**, or seeking such a direct connection, shall provide **NGET** with data on its **User System** which relates to the **Connection Site** and/or which may have a system effect on the performance of the **GB Transmission System**. Such data, current and forecast, is specified in PC.A.2.2 to PC.A.2.5. In addition each **Generator** with **Embedded Large Power Stations** or **Embedded Medium Power Stations** connected to the **Subtransmission System**, shall provide **NGET** with fault infeed data as specified in PC.A.2.5.5 and each **DC Converter** owner with **Embedded DC Converter Stations** connected to the **Subtransmission System** shall provide **NGET** with fault infeed data as specified in PC.A.2.5.6.

PC.A.2.1.2 Each **User** must reflect the system effect at the **Connection Site(s)** of any third party **Embedded** within its **User System** whether existing or proposed.

PC.A.2.1.3 Although not itemised here, each **User** with an existing or proposed **Embedded Small Power Station** or **Medium Power Station** or **Embedded DC Converter Station** with a **Registered Capacity** of less than 100MW or an **Embedded** installation of direct current converters which does not form a **DC Converter Station** in its **User System** may, at **NGET's** reasonable discretion, be required to provide additional details relating to the **User's System** between the **Connection Site** and the existing or proposed **Embedded Small Power Station** or **Medium Power Station** or **Embedded DC Converter Station** or **Embedded** installation of direct current converters which does not form a **DC Converter Station**.

PC.A.2.1.4 At **NGET's** reasonable request, additional data on the **User's System** will need to be supplied. Some of the possible reasons for such a request, and the data required, are given in PC.A.6.2, PC.A.6.4, PC.A.6.5 and PC.A.6.6.

PC.A.2.2 User's System Layout

PC.A.2.2.1 Each **User** shall provide a **Single Line Diagram**, depicting both its existing and proposed arrangement(s) of load current carrying **Apparatus** relating to both existing and proposed **Connection Points**.

PC.A.2.2.2 The **Single Line Diagram** (three examples are shown in Appendix B) must include all parts of the **User System** operating at **Supergrid Voltage** throughout **Great Britain** and, in Scotland, also all parts of the **User System** operating at 132kV, and those parts of its **Subtransmission System** at any **Transmission Site**. In addition, the **Single Line Diagram** must include all parts of the **User's Subtransmission System** throughout **Great Britain** operating at a voltage greater than 50kV, and, in Scotland, also all parts of the **User's Subtransmission System** operating at a voltage greater than 30kV, which, under either intact network or **Planned Outage** conditions:-

- (a) normally interconnects separate **Connection Points**, or busbars at a **Connection Point** which are normally run in separate sections; or
- (b) connects **Embedded Large Power Stations**, or **Embedded Medium Power Stations**, or **Embedded DC Converter Stations** connected to the **User's Subtransmission System**, to a **Connection Point**.

At the **User's** discretion, the **Single Line Diagram** can also contain additional details of the **User's Subtransmission System** not already included above, and also details of the transformers connecting the **User's Subtransmission System** to a lower voltage. With **NGET's** agreement, the **Single Line Diagram** can also contain information about the **User's System** at a voltage below the voltage of the **Subtransmission System**.

The **Single Line Diagram** for a **Power Park Module** must include all parts of the System connecting generating equipment to the **Grid Entry Point** or (**User System Entry Point** if **Embedded**). As an alternative the **User** may choose to submit a **Single Line Diagram** of an electrically equivalent system connecting generating equipment to the **Grid Entry Point** (or **User System Entry Point** if **Embedded**). An example of a **Single Line Diagram** for a **Power Park Module** electrically equivalent system is shown in Appendix B.

The **Single Line Diagram** must include the points at which **Demand** data (provided under PC.A.4.3.4) and fault infeed data (provided under PC.A.2.5) are supplied.

PC.A.2.2.3

The above mentioned **Single Line Diagram** shall include:

- (a) electrical circuitry (ie. overhead lines, identifying which circuits are on the same towers, underground cables, power transformers, reactive compensation equipment and similar equipment); and
- (b) substation names (in full or abbreviated form) with operating voltages.

In addition, for all load current carrying **Apparatus** operating at **Supergrid Voltage** throughout **Great Britain** and, in Scotland, also at 132kV, the **Single Line Diagram** shall include:-

- (a) circuit breakers
- (b) phasing arrangements.

PC.A.2.2.3.1

For the avoidance of doubt, the **Single Line Diagram** to be supplied is in addition to the **Operation Diagram** supplied pursuant to CC.7.4.

PC.A.2.2.4

For each circuit shown on the **Single Line Diagram** provided under PC.A.2.2.1, each **User** shall provide the following details relating to that part of its **User System**:

Circuit Parameters:

Rated voltage (kV)
Operating voltage (kV)
Positive phase sequence reactance
Positive phase sequence resistance
Positive phase sequence susceptance
Zero phase sequence reactance (both self and mutual)
Zero phase sequence resistance (both self and mutual)
Zero phase sequence susceptance (both self and mutual)

In the case of a **Single Line Diagram** for a **Power Park Module** electrically equivalent system the data should be on a 100MVA base. Depending on the equivalent system supplied an equivalent tap changer range may need to be supplied. Similarly mutual values, rated voltage and operating voltage may be inappropriate.

PC.A.2.2.5 For each transformer shown on the **Single Line Diagram** provided under PC.A.2.2.1, each **User** shall provide the following details:

Rated MVA
Voltage Ratio
Winding arrangement
Positive sequence reactance
(max, min and nominal tap)
Positive sequence resistance
(max, min and nominal tap)
Zero sequence reactance

PC.A.2.2.5.1. In addition, for all interconnecting transformers between the **User's Supergrid Voltage System** and the **User's Subtransmission System** throughout **Great Britain** and, in Scotland, also for all interconnecting transformers between the **User's 132kV System** and the **User's Subtransmission System** the **User** shall supply the following information:-

Tap changer range
Tap change step size
Tap changer type: on load or off circuit
Earthing method: Direct, resistance or reactance
Impedance (if not directly earthed)

PC.A.2.2.6 Each **User** shall supply the following information about the **User's** equipment installed at a **Transmission Site**:-

(a) Switchgear. For all circuit breakers:-

Rated voltage (kV)
Operating voltage (kV)
Rated 3-phase rms short-circuit breaking current, (kA)
Rated 1-phase rms short-circuit breaking current, (kA)
Rated 3-phase peak short-circuit making current, (kA)
Rated 1-phase peak short-circuit making current, (kA)
Rated rms continuous current (A)

DC time constant applied at testing of asymmetrical breaking abilities (secs)

- (b) Substation Infrastructure. For the substation infrastructure (including, but not limited to, switch disconnectors, disconnectors, current transformers, line traps, busbars, through bushings, etc):-

Rated 3-phase rms short-circuit withstand current (kA)
Rated 1-phase rms short-circuit withstand current (kA).
Rated 3-phase short-circuit peak withstand current (kA)
Rated 1- phase short-circuit peak withstand current (kA)
Rated duration of short circuit withstand (secs)
Rated rms continuous current (A)

A single value for the entire substation may be supplied, provided it represents the most restrictive item of current carrying apparatus.

PC.A.2.3 Lumped **System** Susceptance

PC.A.2.3.1 For all parts of the **User's Subtransmission System** which are not included in the **Single Line Diagram** provided under PC.A.2.2.1, each **User** shall provide the equivalent lumped shunt susceptance at nominal **Frequency**.

PC.A.2.3.1.1 This should include shunt reactors connected to cables which are not normally in or out of service independent of the cable (ie. they are regarded as part of the cable).

PC.A.2.3.1.2 This should not include:

- (a) independently switched reactive compensation equipment connected to the **User's System** specified under PC.A.2.4, or;
- (b) any susceptance of the **User's System** inherent in the **Demand (Reactive Power)** data specified under PC.A.4.3.1.

PC.A.2.4 Reactive Compensation Equipment

PC.A.2.4.1 For all independently switched reactive compensation equipment, including that shown on the **Single Line Diagram**, not operated by **NGET** and connected to the **User's System** at 132kV and above in England and Wales and 33kV and above in Scotland, other than power factor correction equipment associated directly with **Customers' Plant** and **Apparatus**, the following information is required:

- (a) type of equipment (eg. fixed or variable);
- (b) capacitive and/or inductive rating or its operating range in Mvar;
- (c) details of any automatic control logic to enable operating characteristics to be determined;
- (d) the point of connection to the **User's System** in terms of electrical location and **System** voltage.

PC.A.2.4.2 **DC Converter Station** owners are also required to provide information about the reactive compensation and harmonic filtering equipment required to ensure that their **Plant** and **Apparatus** complies with the criteria set out in CC.6.1.5.

PC.A.2.5 Short Circuit Contribution to **GB Transmission System**

PC.A.2.5.1 General

- (a) To allow **NGET** to calculate fault currents, each **User** is required to provide data, calculated in accordance with **Good Industry Practice**, as set out in the following paragraphs of PC.A.2.5.
- (b) The data should be provided for the **User's System** with all **Generating Units, Power Park Units** and **DC Converters Synchronised** to that **User's System**. The **User** must ensure that the pre-fault network conditions reflect a credible **System** operating arrangement.
- (c) The list of data items required, in whole or part, under the following provisions, is set out in PC.A.2.5.6. Each of the relevant following provisions identifies which data items in the list are required for the situation with which that provision deals.

The fault currents in sub-paragraphs (a) and (b) of the data list in PC.A.2.5.6 should be based on an a.c. load flow that takes into account any pre-fault current flow across the **Point of Connection** being considered.

Measurements made under appropriate **System** conditions may be used by the **User** to obtain the relevant data.

- (d) **NGET** may at any time, in writing, specifically request for data to be provided for an alternative **System** condition, for example minimum plant, and the **User** will, insofar as such request is reasonable, provide the information as soon as reasonably practicable following the request.

PC.A.2.5.2 **Network Operators** and **Non-Embedded Customers** are required to submit data in accordance with PC.A.2.5.4. **Generators** and **DC Converter Station** owners are required to submit data in accordance with PC.A.2.5.5.

PC.A.2.5.3 Where prospective short-circuit currents on equipment owned, operated or managed by **NGET** are close to the equipment rating, and in **NGET's** reasonable opinion more accurate calculations of the prospective short circuit currents are required, then **NGET** will request additional data as outlined in PC.A.6.6 below.

PC.A.2.5.4 Data from **Network Operators** and **Non-Embedded Customers**

Data is required to be provided at each node on the **Single Line Diagram** provided under PC.A.2.2.1 at which motor loads and/or **Embedded Small**

Power Stations and/or **Embedded Medium Power Stations** and/or **Embedded** installations of direct current converters which do not form a **DC Converter Station** are connected, assuming a fault at that location, as follows:-

The data items listed under the following parts of PC.A.2.5.6:-

- (a) (i), (ii), (iii), (iv), (v) and (vi);

and the data items shall be provided in accordance with the detailed provisions of PC.A.2.5.6(c) - (f).

PC.A.2.5.5

Data from **Generators** and **DC Converter Station** owners

PC.A.2.5.5.1

For each **Generating Unit** with one or more associated **Unit Transformers**, the **Generator** is required to provide values for the contribution of the **Power Station Auxiliaries** (including **Auxiliary Gas Turbines** or **Auxiliary Diesel Engines**) to the fault current flowing through the **Unit Transformer(s)**.

The data items listed under the following parts of PC.A.2.5.6(a) should be provided:-

- (i), (ii) and (v);

- (iii) if the associated **Generating Unit** step-up transformer can supply zero phase sequence current from the **Generating Unit** side to the **GB Transmission System**;

- (iv) if the value is not 1.0 p.u;

and the data items shall be provided in accordance with the detailed provisions of PC.A.2.5.6(c) - (f), and with the following parts of this PC.A.2.5.5.

PC.A.2.5.5.2

Auxiliary motor short circuit current contribution and any **Auxiliary Gas Turbine Unit** contribution through the **Unit Transformers** must be represented as a combined short circuit current contribution at the **Generating Unit's** terminals, assuming a fault at that location. In the case of a **Power Park Unit** in a **Power Park Module**, the combined short circuit contribution need only be provided for each type of **Power Park Unit** in the **Power Park Module**.

PC.A.2.5.5.3

If the **Power Station** or **DC Converter Station** has separate **Station Transformers**, data should be provided for the fault current contribution from each transformer at its high voltage terminals, assuming a fault at that location, as follows:-

The data items listed under the following parts of PC.A.2.5.6

- (a) (i), (ii), (iii), (iv), (v) and (vi);

and the data items shall be provided in accordance with the detailed provisions of PC.A.2.5.6(b) - (f).

PC.A.2.5.5.4 Data for the fault infeeds through both **Unit Transformers** and **Station Transformers** shall be provided for the normal running arrangement when the maximum number of **Generating Units** are **Synchronised** to the **System** or when all the **DC Converters** at a **DC Converter Station** are transferring **Rated MW** in either direction. Where there is an alternative running arrangement (or transfer in the case of a **DC Converter Station**) which can give a higher fault infeed through the **Station Transformers**, then a separate data submission representing this condition shall be made.

PC.A.2.5.5.5 Unless the normal operating arrangement within the **Power Station** is to have the **Station** and **Unit Boards** interconnected within the **Power Station**, no account should be taken of the interconnection between the **Station Board** and the **Unit Board**.

PC.A.2.5.5.6 Auxiliary motor short circuit current contribution and any auxiliary **DC Converter Station** contribution through the **Station Transformers** must be represented as a combined short circuit current contribution through the **Station Transformers**.

PC.A.2.5.6 Data Items

(a) The following is the list of data utilised in this part of the **PC**. It also contains rules on the data which generally apply:-

- (i) Root mean square of the symmetrical three-phase short circuit current infeed at the instant of fault, (I_1'');
- (ii) Root mean square of the symmetrical three-phase short circuit current after the subtransient fault current contribution has substantially decayed, (I_1');
- (iii) the zero sequence source resistance and reactance values of the **User's System** as seen from the node on the **Single Line Diagram** provided under PC.A.2.2.1 (or **Station Transformer** high voltage terminals or **Generating Unit** terminals or **DC Converter** terminals, as appropriate) consistent with the infeed described in PC.A.2.5.1.(b);
- (iv) root mean square of the pre-fault voltage at which the maximum fault currents were calculated;
- (v) the positive sequence X/R ratio at the instant of fault;
- (vi) the negative sequence resistance and reactance values of the **User's System** seen from the node on the **Single Line Diagram** provided under PC.A.2.2.1 (or **Station Transformer** high voltage terminals, or **Generating Unit** terminals or **DC Converter** terminals if appropriate) if substantially different from the values of positive sequence resistance and reactance which would be derived from the data provided above.

- (b) In considering this data, unless the **User** notifies **NGET** accordingly at the time of data submission, **NGET** will assume that the time constant of decay of the subtransient fault current corresponding to the change from I_1 to I_1' , (T) is not significantly different from 40ms. If that assumption is not correct in relation to an item of data, the **User** must inform **NGET** at the time of submission of the data.
- (c) The value for the X/R ratio must reflect the rate of decay of the d.c. component that may be present in the fault current and hence that of the sources of the initial fault current. All shunt elements and loads must therefore be deleted from any system model before the X/R ratio is calculated.
- (d) In producing the data, the **User** may use "time step analysis" or "fixed-point-in-time analysis" with different impedances.
- (e) If a fixed-point-in-time analysis with different impedances method is used, then in relation to the data submitted under (a) (i) above, the data will be required for "time zero" to give I_1 ". The figure of 120ms is consistent with a decay time constant T " of 40ms, and if that figure is different, then the figure of 120ms must be changed accordingly.
- (f) Where a "time step analysis" is carried out, the X/R ratio may be calculated directly from the rate of decay of the d.c. component. The X/R ratio is not that given by the phase angle of the fault current if this is based on a system calculation with shunt loads, but from the Thévenin equivalent of the system impedance at the instant of fault with all non-source shunts removed.

PC.A.3 **GENERATING UNIT AND DC CONVERTER DATA**

PC.A.3.1 **Introduction**

Directly Connected

PC.A.3.1.1 Each **Generator** and **DC Converter Station** owner with an existing, or proposed, **Power Station** or **DC Converter Station** directly connected, or to be directly connected, to the **GB Transmission System**, shall provide **NGET** with data relating to that **Power Station** or **DC Converter Station**, both current and forecast, as specified in PC.A.3.2 to PC.A.3.4.

Embedded

PC.A.3.1.2 (a) Each **Generator** and **DC Converter Station** owner with an existing, or proposed, **Embedded Large Power Station** and/or an **Embedded Medium Power Station** and/or **Embedded DC Converter Station** connected to the **Sub Transmission System**, shall provide **NGET** with data relating to that **Power Station** or **DC Converter Station**, both current and forecast, as specified in PC.A.3.2 to PC.A.3.4.

(b) No data need be supplied in relation to any **Small Power Station** or any **Medium Power Station** or installations of direct current converters which do not form a **DC Converter Station**, connected at a voltage level below the voltage level of the **Subtransmission System** except:-

(i) in connection with an application for, or under, a **CUSC Contract**, or

(ii) unless specifically requested by **NGET** under PC.A.3.1.4.

PC.A.3.1.3 (a) Each **Network Operator** shall provide **NGET** with the data specified in PC.A.3.2.2(c) and PC.A.3.2.2(i).

(b) **Network Operators** need not submit planning data in respect of an **Embedded Small Power Station** unless required to do so under PC.A.1.2(b) or unless specifically requested under PC.A.3.1.4 below, in which case they will supply such data.

PC.A.3.1.4 (a) PC.A.4.2.4(b) and PC.A.4.3.2(a) explain that the forecast **Demand** submitted by each **Network Operator** must be net of the output of all **Small Power Stations** and **Medium Power Stations** and **Customer Generating Plant** and all installations of direct current converters which do not form a **DC Converter Station Embedded** in that **Network Operator's System**. The **Network Operator** must inform **NGET** of the number of such **Embedded Power Stations** and such **Embedded** installations of direct current converters (including the number of **Generating Units** or **Power Park Modules** or **DC Converters**) together with their summated capacity.

- (b) On receipt of this data, the **Network Operator** or **Generator** (if the data relates to **Power Stations** referred to in PC.A.3.1.2) may be further required, at **NGET's** reasonable discretion, to provide details of **Embedded Small Power Stations** and **Embedded Medium Power Stations** and **Customer Generating Plant** and **Embedded** installations of direct current converters which do not form a **DC Converter Station**, both current and forecast, as specified in PC.A.3.2 to PC.A.3.4. Such requirement would arise where **NGET** reasonably considers that the collective effect of a number of such **Embedded Power Stations** and **Customer Generating Plants** and **Embedded** installations of direct current converters may have a significant system effect on the **GB Transmission System**.

PC.A.3.1.5 Where **Generating Units**, which term includes **CCGT Units** and **Power Park Modules**, and **DC Converters**, are connected to the **GB Transmission System** via a busbar arrangement which is or is expected to be operated in separate sections, the section of busbar to which each **Generating Unit**, **DC Converter** or **Power Park Module** is connected is to be identified in the submission.

PC.A.3.2 Output Data

PC.A.3.2.1 (a) **Large Power Stations and Gensets**

Data items PC.A.3.2.2 (a), (b), (c), (d), (e), (f) and (h) are required with respect to each **Large Power Station** and each **Generating Unit** and **Power Park Module** of each **Large Power Station** and for each **Genset** (although (a) is not required for **CCGT Units** and (b), (d) and (e) are not normally required for **CCGT Units** and (a), (b), (c), (d), (e), (f) and (h) are not normally required for **Power Park Units**).

(b) **Embedded Small Power Stations and Embedded Medium Power Stations**

Data item PC.A.3.2.2 (a) is required with respect to each **Embedded Small Power Station** and **Embedded Medium Power Station** and each **Generating Unit** and **Power Park Module** of each **Embedded Small Power Station** and **Embedded Medium Power Station** (although (a) is not required for **CCGT Units** or **Power Park Units**).

(c) **CCGT Units/Modules**

(i) Data item PC.A.3.2.2 (g) is required with respect to each **CCGT Unit**;

(ii) data item PC.A.3.2.2 (a) is required with respect to each **CCGT Module**; and

(iii) data items PC.A.3.2.2 (b), (c), (d) and (e) are required with respect to each **CCGT Module** unless **NGET** informs the relevant **User** in advance of the submission that it needs the data items with respect to each **CCGT Unit** for

particular studies, in which case it must be supplied on a **CCGT Unit** basis.

Where any definition utilised or referred to in relation to any of the data items does not reflect **CCGT Units**, such definition shall be deemed to relate to **CCGT Units** for the purposes of these data items. Any **Schedule** in the DRC which refers to these data items shall be interpreted to incorporate the **CCGT Unit** basis where appropriate;

(d) **Cascade Hydro Schemes**

Data item PC.A.3.2.2(i) is required with respect to each **Cascade Hydro Scheme**.

(e) **Power Park Units/Modules**

Data items PC.A.3.2.2 (j) is required with respect to each **Power Park Module**.

(f) **DC Converters**

Data items PC.A.3.2.2 (a), (b), (c), (d) (e) (f) (h) and (i) are required with respect to each **DC Converter Station** and each **DC Converter** in each **DC Converter Station**. For installations of direct current converters which do not form a **DC Converter Station** only data item PC.A.3.2.2.(a) is required.

PC.A.3.2.2

Items (a), (b), (d), (e), (f), (g), (h), (i), (j) and (k) are to be supplied by each **Generator**, **DC Converter Station** owner or **Network Operator** (as the case may be) in accordance with PC.A.3.1.1, PC.A.3.1.2, PC.A.3.1.3 and PC.A.3.1.4. Item (c) is to be supplied by each **Network Operator** in all cases:-

- (a) **Registered Capacity** (MW);
- (b) **Output Usable** (MW) on a monthly basis;
- (c) **System Constrained Capacity** (MW) ie. any constraint placed on the capacity of the **Embedded Generating Unit**, **Embedded Power Park Module**, or **DC Converter** at an **Embedded DC Converter Station** due to the **Network Operator's System** in which it is embedded. Where **Generating Units** (which term includes **CCGT Units**), **Power Park Modules** or **DC Converters** are connected to a **Network Operator's User System** via a busbar arrangement which is or is expected to be operated in separate sections, details of busbar running arrangements and connected circuits at the substation to which the **Embedded Generating Unit**, **Embedded Power Park Module** or **Embedded DC Converter** is connected sufficient for **NGET** to determine where the **MW** generated by each **Generating Unit**, **Power Park Module** or **DC Converter** at that **Power Station** or **DC Converter Station** would appear onto the **GB Transmission System**;

- (d) **Minimum Generation (MW);**
- (e) MW obtainable from **Generating Units, Power Park Modules or DC Converters** at a **DC Converter Station** in excess of **Registered Capacity;**
- (f) **Generator Performance Chart:**
 - (i) at the **Synchronous Generating Unit** stator terminals
 - (ii) at the electrical point of connection to the **GB Transmission System** (or **User System** if **Embedded**) for a **Non Synchronous Generating Unit** (excluding a **Power Park Unit**), **Power Park Module** and **DC Converter** at a **DC Converter Station;**
- (g) a list of the **CCGT Units** within a **CCGT Module**, identifying each **CCGT Unit**, and the **CCGT Module** of which it forms part, unambiguously. In the case of a **Range CCGT Module**, details of the possible configurations should also be submitted, together:-
 - (i) (in the case of a **Range CCGT Module** connected to the **GB Transmission System**) with details of the single **Grid Entry Point** (there can only be one) at which power is provided from the **Range CCGT Module;**
 - (ii) (in the case of an **Embedded Range CCGT Module**) with details of the single **User System Entry Point** (there can only be one) at which power is provided from the **Range CCGT Module;**

Provided that, nothing in this sub-paragraph (g) shall prevent the busbar at the relevant point being operated in separate sections;
- (h) expected running regime(s) at each **Power Station** or **DC Converter Station** and type of **Generating Unit**, eg. **Steam Unit, Gas Turbine Unit, Combined Cycle Gas Turbine Unit, Power Park Module, Novel Units** (specify by type), etc;
- (i) a list of **Power Stations** and **Generating Units** within a **Cascade Hydro Scheme**, identifying each **Generating Unit** and **Power Station** and the **Cascade Hydro Scheme** of which each form part unambiguously. In addition:
 - (i) details of the **Grid Entry Point** at which **Active Power** is provided, or if **Embedded** the **Grid Supply Point(s)** within which the **Generating Unit** is connected;
 - (ii) where the **Active Power** output of a **Generating Unit** is split between more than one **Grid Supply Points** the percentage that would appear under normal and outage conditions at each **Grid Supply Point.**

- (j) The following additional items are only applicable to **DC Converters** at **DC Converter Stations**.

Registered Import Capacity (MW);

Import Usable (MW) on a monthly basis;

Minimum Import Capacity (MW);

MW that may be absorbed by a **DC Converter** in excess of **Registered Import Capacity** and the duration for which this is available;

- (k) the number and types of the **Power Park Units** within a **Power Park Module**, identifying each **Power Park Unit**, and the **Power Park Module** of which it forms part, unambiguously. In the case of a **Power Station** directly connected to the **GB Transmission System** with multiple **Power Park Modules** where **Power Park Units** can be selected to run in different **Power Park Modules**, details of the possible configurations should also be submitted.

PC.A.3.2.3

Notwithstanding any other provision of this PC, the **CCGT Units** within a **CCGT Module**, details of which are required under paragraph (g) of PC.A.3.2.2, can only be amended in accordance with the following provisions:-

- (a) if the **CCGT Module** is a **Normal CCGT Module**, the **CCGT Units** within that **CCGT Module** can only be amended such that the **CCGT Module** comprises different **CCGT Units** if **NGET** gives its prior consent in writing. Notice of the wish to amend the **CCGT Units** within such a **CCGT Module** must be given at least 6 months before it is wished for the amendment to take effect;
- (b) if the **CCGT Module** is a **Range CCGT Module**, the **CCGT Units** within that **CCGT Module** and the **Grid Entry Point** at which the power is provided can only be amended as described in BC1.A1.6.4.

PC.A.3.2.4

Notwithstanding any other provision of this PC, the **Power Park Units** within a **Power Park Module**, details of which are required under paragraph (j) of PC.A.3.2.2, can only be amended in accordance with the following provisions:-

- (a) if the **Power Park Units** within that **Power Park Module** can only be amended such that the **Power Park Module** comprises different **Power Park Units** due to repair/replacement of individual **Power Park Units** if **NGET** gives its prior consent in writing. Notice of the wish to amend a **Power Park Unit** within such a **Power Park Module** must be given at least 4 weeks before it is wished for the amendment to take effect;
- (b) if the **Power Park Units** within that **Power Park Module** can be selected to run in different **Power Park Modules** as an alternative operational running arrangement the **Power Park Units** within the

Power Park Module and the **Grid Entry Point** at which the power is provided can only be amended as described in BC1.A.1.7.4.

PC.A.3.3. Rated Parameters Data

PC.A.3.3.1 The following information is required to facilitate an early assessment, by **NGET**, of the need for more detailed studies;

- (a) for all **Generating Units**(excluding **Power Park Units**) and **Power Park Modules**:

Rated MVA
Rated MW;

- (b) for each **Synchronous Generating Unit**:

Short circuit ratio
Direct axis transient reactance;
Inertia constant (for whole machine), MWsecs/MVA;

- (c) for each **Synchronous Generating Unit** step-up transformer:

Rated MVA
Positive sequence reactance (at max, min and nominal tap);

- (d) for each **DC Converter** at a **DC Converter Station** or **DC Converter** connecting a **Power Park Module**

DC Converter type (e.g. current/voltage sourced)
Rated MW per pole for import and export
Number of poles and pole arrangement
Rated DC voltage/pole (kV)
Return path arrangement
Remote AC connection arrangement

- (e) for each type of **Power Park Unit** in a **Power Park Module** not connected to the **Total System** by a **DC Converter**:

Rated MVA
Rated MW
Rated terminal voltage
Inertia constant, (MWsec/MVA)
Additionally, for **Power Park Units** that are squirrel-cage or doubly-fed induction generators driven by wind turbines:
Stator reactance.
Magnetising reactance.
Rotor resistance (at rated running)
Rotor reactance (at rated running)
The generator rotor speed range (minimum and maximum speeds in RPM) (for doubly-fed induction generators only)
Converter MVA rating (for doubly-fed induction generators only)

For a **Power Park Unit** consisting of a synchronous machine in combination with a back-to-back **DC Converter**, or for a **Power Park Unit** not driven by a wind turbine, the data to be supplied shall be agreed with **NGET** in accordance with PC.A.7.

This information should only be given in the data supplied with the application for a **CUSC Contract** (if appropriate for any variation), as the case may be.

PC.A.3.4

General **Generating Unit Power Park Module and DC Converter** Data

PC.A.3.4.1

The point of connection to the **GB Transmission System** or the **Total System**, if other than to the **GB Transmission System**, in terms of geographical and electrical location and system voltage is also required.

PC.A.3.4.2

- (a) Type of **Generating Unit** (ie **Synchronous Generating Unit, Non-synchronous Generating Unit , DC Converter or Power Park Module**).
- (b) In the case of a **Synchronous Generating Unit** details of the **Exciter** category, for example whether it is a rotating **Exciter** or a static **Exciter** or in the case of a **Non-Synchronous Generating Unit** the voltage control system.
- (c) Whether a **Power System Stabiliser** is fitted.

PC.A.4 **DEMAND AND ACTIVE ENERGY DATA**

PC.A.4.1 **Introduction**

PC.A.4.1.1 Each **User** directly connected to the **GB Transmission System** with **Demand** shall provide **NGET** with the **Demand** data, historic, current and forecast, as specified in PC.A.4.2, PC.A.4.3 and PC.A.4.5. Paragraphs PC.A.4.1.2 and PC.A.4.1.3 apply equally to **Active Energy** requirements as to **Demand** unless the context otherwise requires.

PC.A.4.1.2 Data will need to be supplied by:

- (a) each **Network Operator**, in relation to **Demand** and **Active Energy** requirements on its **User System**;
- (b) each **Non-Embedded Customer** (including **Pumped Storage Generators** with respect to Pumping **Demand**) in relation to its **Demand** and **Active Energy** requirements.
- (c) each **DC Converter Station** owner, in relation to **Demand** and **Active Energy** transferred (imported) to its **DC Converter Station**.

Demand of **Power Stations** directly connected to the **GB Transmission System** is to be supplied by the **Generator** under PC.A.5.2.

PC.A.4.1.3 References in this **PC** to data being supplied on a half hourly basis refer to it being supplied for each period of 30 minutes ending on the hour or half-hour in each hour.

PC.A.4.2 **Demand (Active Power) and Active Energy Data**

PC.A.4.2.1 Forecast daily **Demand (Active Power)** profiles, as specified in (a), (b) and (c) below, in respect of each of the **User's User Systems** (each summated over all **Grid Supply Points** in each **User System**) are required for:

- (a) peak day on each of the **User's User Systems** (as determined by the **User**) giving the numerical value of the maximum **Demand (Active Power)** that in the **Users'** opinion could reasonably be imposed on the **GB Transmission System**;
- (b) day of peak **GB Transmission System Demand (Active Power)** as notified by **NGET** pursuant to PC.A.4.2.2;
- (c) day of minimum **GB Transmission System Demand (Active Power)** as notified by **NGET** pursuant to PC.A.4.2.2.

In addition, the total **Demand (Active Power)** in respect of the time of peak **GB Transmission System Demand** in the preceding **Financial Year** in respect of each of the **User's User Systems** (each summated over all **Grid**

Supply Points in each **User System**) both outturn and weather corrected shall be supplied.

PC.A.4.2.2 No later than calendar week 17 each year **NGET** shall notify each **Network Operator** and **Non-Embedded Customer** in writing of the following, for the current **Financial Year** and for each of the following seven **Financial Years**, which will, until replaced by the following year's notification, be regarded as the relevant specified days and times under PC.A.4.2.1:

- a) the date and time of the annual peak of the **GB Transmission System Demand**;
- b) the date and time of the annual minimum of the **GB Transmission System Demand**.

PC.A.4.2.3 The total **Active Energy** used on each of the **Network Operators'** or **Non-Embedded Customers' User Systems** (each summated over all **Grid Supply Points** in each **User System**) in the preceding **Financial Year**, both outturn and weather corrected, together with a prediction for the current financial year, is required. Each **Active Energy** submission shall be subdivided into the following categories of **Customer** tariff:

- LV1
- LV2
- LV3
- HV
- EHV
- Traction
- Lighting

In addition, the total **User System** losses and the **Active Energy** provided by **Embedded Small Power Stations** and **Embedded Medium Power Stations** shall be supplied.

PC.A.4.2.4 All forecast **Demand (Active Power)** and **Active Energy** specified in PC.A.4.2.1 and PC.A.4.2.3 shall:

- (a) in the case of PC.A.4.2.1(a), (b) and (c), be such that the profiles comprise average **Active Power** levels in 'MW' for each time marked half hour throughout the day;
- (b) in the case of PC.A.4.2.1(a), (b) and (c), be that remaining after any deductions reasonably considered appropriate by the **User** to take account of the output profile of all **Embedded Small Power Stations** and **Embedded Medium Power Stations** and **Customer Generating Plant** and imports across **Embedded External Interconnections** including imports across **Embedded** installations of direct current converters which do not form a **DC Converter Station** and **Embedded DC Converter Stations** with a **Registered Capacity** of less than 100MW;

- (c) in the case of PC.A.4.2.1(a) and (b), be based on **Annual ACS Conditions** and in the case of PC.A.4.2.1(c) and the details of the annual **Active Energy** required under PC.A.4.2.3 be based on **Average Conditions**.

PC.A.4.3

Connection Point Demand (Active and Reactive Power)

PC.A.4.3.1

Forecast **Demand (Active Power)** and **Power Factor** (values of the **Power Factor** at maximum and minimum continuous excitation may be given instead where more than 95% of the total **Demand** at a **Connection Point** is taken by synchronous motors) to be met at each are required for:

- (a) the time of the maximum **Demand (Active Power)** at the **Connection Point** (as determined by the **User**) that in the **User's** opinion could reasonably be imposed on the **GB Transmission System**;
- (b) the time of peak **GB Transmission System Demand** as provided by **NGET** under PC.A.4.2.2;
- (c) the time of minimum **GB Transmission System Demand** as provided by **NGET** under PC.A.4.2.2.

PC.A.4.3.2

All forecast **Demand** specified in PC.A.4.3.1 shall:

- (a) be that remaining after any deductions reasonably considered appropriate by the **User** to take account of the output of all **Embedded Small Power Stations** and **Embedded Medium Power Stations** and **Customer Generating Plant** and imports across **Embedded External Interconnections**, including **Embedded** installations of direct current converters which do not form a **DC Converter Station** and **Embedded DC Converter Stations** and such deductions should be separately stated;
- (b) include any **User's System** series reactive losses but exclude any reactive compensation equipment specified in PC.A.2.4 and exclude any network susceptance specified in PC.A.2.3;
- (c) in the case of PC.A.4.3.1(a) and (b) be based on **Annual ACS Conditions** and in the case of PC.A.4.3.1(c) be based on **Average Conditions**.

PC.A.4.3.3

Where two or more **Connection Points** normally run in parallel with the **GB Transmission System** under intact network conditions, and a **Single Line Diagram** of the interconnection has been provided under PC.A.2.2.2, the **User** may provide a single submission covering the aggregate **Demand** for all such **Connection Points**.

PC.A.4.3.4

Each **Single Line Diagram** provided under PC.A.2.2.2 shall include the **Demand (Active Power)** and **Power Factor** (values of the **Power Factor** at maximum and minimum continuous excitation may be given instead where more than 95% of the **Demand** is taken by synchronous motors) at the time of the peak **GB Transmission System Demand** (as provided under

PC.A.4.2.2) at each node on the **Single Line Diagram**. These **Demands** shall be consistent with those provided under PC.A.4.3.1(b) above for the relevant year.

PC.A.4.3.5 So that **NGET** is able to assess the impact on the **GB Transmission System** of the diversified **GB Transmission System Demand** at various periods throughout the year, each **User** shall provide additional forecast **Demand** data as specified in PC.A.4.3.1 and PC.A.4.3.2 but with respect to times to be specified by **NGET**. However, **NGET** shall not make such a request for additional data more than once in any calendar year.

PC.A.4.4 **NGET** will assemble and derive in a reasonable manner, the forecast information supplied to it under PC.A.4.2.1, PC.A.4.3.1. and PC.A.4.3.4 above into a cohesive forecast and will use this in preparing **Forecast Demand** information in the **Seven Year Statement** and for use in **NGET's Operational Planning**. If any **User** believes that the cohesive forecast **Demand** information in the **Seven Year Statement** does not reflect its assumptions on **Demand**, it should contact **NGET** to explain its concerns and may require **NGET**, on reasonable request, to discuss these forecasts. In the absence of such expressions, **NGET** will assume that **Users** concur with **NGET's** cohesive forecast.

Demand Transfer Capability

PC.A.4.5 Where a **User's Demand** or group of **Demands (Active and Reactive Power)** may be offered by the **User** to be supplied from alternative **Connection Point(s)**, (either through non-**Transmission** interconnections or through **Demand** transfer facilities) and the **User** reasonably considers it appropriate that this should be taken into account (by **NGET**) in designing the **Connection Site** the following information is required:

- (a) **First Circuit (Fault) Outage Conditions**
 - (i) the alternative **Connection Point(s)**;
 - (ii) the **Demand (Active and Reactive Power)** which may be transferred under the loss of the most critical circuit from or to each alternative **Connection Point** (to the nearest 5MW/5Mvar);
 - (iii) the arrangements (eg. manual or automatic) for transfer together with the time required to effect the transfer.
- (b) **Second Circuit (Planned) Outage Conditions**
 - (i) the alternative **Connection Point(s)**;
 - (ii) the **Demand (Active and Reactive Power)** which may be transferred under the loss of the most critical circuit from or to each alternative **Connection Point** (to the nearest 5MW/5Mvar);

- (iii) the arrangements (eg. manual or automatic) for transfer together with the time required to effect the transfer.

PC.A.4.6 Control of **Demand** or Reduction of Pumping Load Offered as Reserve

- Magnitude of **Demand** or pumping load which is tripped MW
- **System Frequency** at which tripping is initiated Hz
- Time duration of **System Frequency** below trip setting for tripping to be initiated s
- Time delay from trip initiation to tripping s

PC.A.4.7 General **Demand** Data

PC.A.4.7.1 The following information is infrequently required and should be supplied (wherever possible) when requested by **NGET**:

- (a) details of any individual loads which have characteristics significantly different from the typical range of Domestic, Commercial or Industrial loads supplied;
- (b) the sensitivity of the **Demand (Active and Reactive Power)** to variations in voltage and **Frequency** on the **GB Transmission System** at the time of the peak **Demand (Active Power)**. The sensitivity factors quoted for the **Demand (Reactive Power)** should relate to that given under PC.A.4.3.1 and, therefore, include any **User's System** series reactive losses but exclude any reactive compensation equipment specified in PC.A.2.4 and exclude any network susceptance specified in PC.A.2.3;
- (c) details of any traction loads, e.g. connection phase pairs and continuous load variation with time;
- (d) the average and maximum phase unbalance, in magnitude and phase angle, which the **User** would expect its **Demand** to impose on the **GB Transmission System**;
- (e) the maximum harmonic content which the **User** would expect its **Demand** to impose on the **GB Transmission System**;
- (f) details of all loads which may cause **Demand** fluctuations greater than those permitted under **Engineering Recommendation P28, Stage 1** at a **Point of Common Coupling** including the **Flicker Severity (Short Term)** and the **Flicker Severity (Long Term)**.

PART 2

DETAILED PLANNING DATA

PC.A.5 GENERATING UNIT, POWER PARK MODULE AND DC CONVERTER DATA

PC.A.5.1 Introduction

Directly Connected

PC.A.5.1.1 Each **Generator**, with existing or proposed **Power Stations** directly connected, or to be directly connected, to the **GB Transmission System**, shall provide **NGET** with data relating to that **Plant and Apparatus**, both current and forecast, as specified in PC.A.5.2, PC.A.5.3 and PC.A.5.4 as applicable. Each **DC Converter Station** owner, with existing or proposed **DC Converter Stations** directly connected, or to be directly connected, to the **GB Transmission System**, shall provide **NGET** with data relating to that **Plant and Apparatus**, both current and forecast, as specified in PC.A.5.2 and PC.A.5.4.

Embedded

PC.A.5.1.2 Each **Generator**, with existing or proposed **Embedded Large Power Stations** and **Embedded Medium Power Stations** shall provide **NGET** with data relating to each of those **Large Power Stations** and/or **Medium Power Stations**, both current and forecast, as specified in PC.A.5.2, PC.A.5.3 and PC.A.5.4 as applicable. Each **DC Converter Station** owner, with existing or proposed **DC Converter Stations** shall provide **NGET** with data relating to each of those **DC Converter Stations**, both current and forecast, as specified in PC.A.5.2 and PC.A.5.4. However, no data need be supplied in relation to those **Embedded Medium Power Stations** if they are connected at a voltage level below the voltage level of the **Subtransmission System** except in connection with an application for, or under a, **CUSC Contract** or unless specifically requested by **NGET** under PC.A.5.1.4.

PC.A.5.1.3 Each **Network Operator** need not submit **Planning Data** in respect of **Embedded Small Power Stations** unless required to do so under PC.A.1.2(b) or unless specifically requested under PC.A.5.1.4 below, in which case they will supply such data.

PC.A.5.1.4 PC.A.4.2.4(b) and PC.A.4.3.2(a) explained that the forecast **Demand** submitted by each **Network Operator** must be net of the output of all **Medium Power Stations** and **Small Power Stations** and **Customer Generating Plant Embedded** in that **User's System**. In such cases (PC.A.3.1.4 also refers), the **Network Operator** must inform **NGET** of the number of such **Power Stations** (including the number of **Generating Units**) together with their summated capacity. On receipt of this data, the **Network Operator** or **Generator** (if the data relates to **Power Stations** referred to in PC.A.5.1.2) may be further required at **NGET's** discretion to provide details of **Embedded Small Power Stations** and **Embedded Medium Power Stations** and **Customer Generating Plant**, both current

and forecast, as specified in PC.A.5.2 and PC.A.5.3. Such requirement would arise when **NET** reasonably considers that the collective effect of a number of such **Embedded Small Power Stations and Embedded Medium Power Stations** and **Customer Generating Plants** may have a significant system effect on the **GB Transmission System**.

PC.A.5.2 **Demand**

PC.A.5.2.1 For each **Generating Unit** which has an associated **Unit Transformer**, the value of the **Demand** supplied through this **Unit Transformer** when the **Generating Unit** is at **Rated MW** output is to be provided.

PC.A.5.2.2 Where the **Power Station** or **DC Converter Station** has associated **Demand** additional to the unit-supplied **Demand** of PC.A.5.2.1 which is supplied from either the **GB Transmission System** or the **Generator's User System** the **Generator** or **DC Converter Station** owner shall supply forecasts for each **Power Station** or **DC Converter Station** of:

- a) the maximum **Demand** that, in the **User's** opinion, could reasonably be imposed on the **GB Transmission System** or the **Generator's User System** as appropriate;
- b) the **Demand** at the time of the peak **GB Transmission System Demand**;
- c) the **Demand** at the time of minimum **GB Transmission System Demand**.

PC.A.5.2.3 No later than calendar week 17 each year **NET** shall notify each **Generator** with **Large Power Stations** and/or **Medium Power Stations** in writing of the following, for the current **Financial Year** and for each of the following seven **Financial Years**, which will be regarded as the relevant specified days and times under PC.A.5.2.2:

- a) the date and time of the annual peak of the **GB Transmission System Demand** at **Annual ACS Conditions**;
- b) the date and time of the annual minimum of the **GB Transmission System Demand** at **Average Conditions**.

PC.A.5.2.4 At its discretion, **NET** may also request further details of the **Demand** as specified in PC.A.4.6

PC.A.5.3 **Synchronous Generating Unit and Associated Control System Data**

PC.A.5.3.1 The data submitted below are not intended to constrain any **Ancillary Services Agreement**

PC.A.5.3.2 The following **Synchronous Generating Unit** and **Power Station** data should be supplied:

(a) **Synchronous Generating Unit Parameters**

- Rated terminal volts (kV)
- * Rated MVA
- * **Rated MW**
- * Minimum Generation MW
- * Short circuit ratio
- Direct axis synchronous reactance
- * Direct axis transient reactance
- Direct axis sub-transient reactance
- Direct axis short-circuit transient time constant.
- Direct axis short-circuit sub-transient time constant.
- Quadrature axis synchronous reactance
- Quadrature axis sub-transient reactance
- Quadrature axis short-circuit sub-transient time constant.
- Stator time constant
- Stator leakage reactance
- Armature winding direct-current resistance.

Note: The above data item relating to armature winding direct-current resistance need only be supplied by **Generators** with respect to **Generating Units** commissioned after 1st March 1996 and in cases where, for whatever reason, the **Generator** is aware of the value of the relevant parameter.

- * Turbogenerator inertia constant (MWsec/MVA)
- Rated field current (amps) at **Rated MW** and Mvar output and at rated terminal voltage.

Field current (amps) open circuit saturation curve for **Generating Unit** terminal voltages ranging from 50% to 120% of rated value in 10% steps as derived from appropriate manufacturers test certificates.

(b) **Parameters for Generating Unit Step-up Transformers**

- * Rated MVA
- Voltage ratio
- * Positive sequence reactance
(at max, min, & nominal tap)
- Positive sequence resistance
(at max, min, & nominal tap)
- Zero phase sequence reactance
- Tap changer range
- Tap changer step size
- Tap changer type: on load or off circuit

(c) **Excitation Control System parameters**

Note: The data items requested under Option 1 below may continue to be provided by **Generators** in relation to **Generating Units** on the **System** at 09 January 1995

(in this paragraph, the "relevant date") or they may provide the new data items set out under Option 2. **Generators** must supply the data as set out under Option 2 (and not those under Option 1) for **Generating Unit** excitation control systems commissioned after the relevant date, those **Generating Unit** excitation control systems recommissioned for any reason such as refurbishment after the relevant date and **Generating Unit** excitation control systems where, as a result of testing or other process, the **Generator** is aware of the data items listed under Option 2 in relation to that **Generating Unit**.

Option 1

DC gain of **Excitation Loop**

Rated field voltage

Maximum field voltage

Minimum field voltage

Maximum rate of change of field voltage (rising)

Maximum rate of change of field voltage (falling)

Details of **Excitation Loop** described in block diagram form showing transfer functions of individual elements.

Dynamic characteristics of **Over-excitation Limiter**.

Dynamic characteristics of **Under-excitation Limiter**

Option 2

Excitation System Nominal Response

Rated Field Voltage

No-Load Field Voltage

Excitation System On-Load Positive Ceiling Voltage

Excitation System No-Load Positive Ceiling Voltage

Excitation System No-Load Negative Ceiling Voltage

Details of **Excitation System** (including **PSS** if fitted) described in block diagram form showing transfer functions of individual elements.

Details of **Over-excitation Limiter** described in block diagram form showing transfer functions of individual elements.

Details of **Under-excitation Limiter** described in block diagram form showing transfer functions of individual elements.

(d) Governor Parameters

Incremental Droop values (in %) are required for each **Generating Unit** at six MW loading points (MLP1 to MLP6) as detailed in PC.A.5.5.1 (this data item needs only be provided for **Large Power Stations**)

Note: The data items requested under Option 1 below may continue to be provided by **Generators** in relation to **Generating Units** on the **System** at 09 January 1995 (in this paragraph, the "relevant date") or they may provide the new data items set out under Option 2. **Generators** must supply the data as set out under Option 2 (and not those under Option 1) for **Generating Unit** governor control systems commissioned after the relevant date, those **Generating Unit** governor control systems recommissioned for any reason such as refurbishment after the relevant date and **Generating Unit** governor control systems where, as a result of testing or other process, the **Generator** is aware of the data items listed under Option 2 in relation to that **Generating Unit**.

Option 1

(i) Governor Parameters (for Reheat **Steam Units**)

HP governor average gain MW/Hz
Speeder motor setting range
HP governor valve time constant
HP governor valve opening limits
HP governor valve rate limits
Reheater time constant (**Active Energy** stored in reheater)

IP governor average gain MW/Hz
IP governor setting range
IP governor valve time constant
IP governor valve opening limits
IP governor valve rate limits

Details of acceleration sensitive elements in HP & IP governor loop.
A governor block diagram showing transfer functions of individual elements.

(ii) Governor Parameters (for Non-Reheat **Steam Units** and **Gas Turbine Units**)

Governor average gain
Speeder motor setting range
Time constant of steam or fuel governor valve
Governor valve opening limits
Governor valve rate limits
Time constant of turbine
Governor block diagram

The following data items need only be supplied for **Large Power Stations**:-

(iii) Boiler & Steam Turbine Data

Boiler Time Constant (Stored **Active Energy**)
s

HP turbine response ratio:
proportion of **Primary Response**
%
arising from HP turbine.

HP turbine response ratio:
proportion of **High Frequency Response**
%
arising from HP turbine.

[End of Option 1]

Option 2

(i) Governor and associated prime mover Parameters -
All **Generating Units**

Governor Block Diagram showing transfer function of individual elements including acceleration sensitive elements.

Governor Time Constant (in seconds)

Speeder Motor Setting Range (%)

Average Gain (MW/Hz)

Governor Deadband (this data item need only be provided for **Large Power Stations**)

- Maximum Setting ±Hz

- Normal Setting ±Hz

- Minimum Setting ±Hz

Where the **Generating Unit** governor does not have a selectable deadband facility, then the actual value of the deadband need only be provided

(ii) Governor and associated prime mover Parameters -
Steam Units

HP Valve Time Constant (in seconds)

HP Valve Opening Limits (%)

HP Valve Opening Rate Limits (%/second)

HP Valve Closing Rate Limits (%/second)

HP Turbine Time Constant (in seconds)

IP Valve Time Constant (in seconds)

IP Valve Opening Limits (%)

IP Valve Opening Rate Limits (%/second)

IP Valve Closing Rate Limits (%/second)

IP Turbine Time Constant (in seconds)

LP Valve Time Constant (in seconds)

LP Valve Opening Limits (%)
LP Valve Opening Rate Limits (%/second)
LP Valve Closing Rate Limits (%/second)
LP Turbine Time Constant (in seconds)

Reheater Time Constant (in seconds)
Boiler Time Constant (in seconds)
HP Power Fraction (%)
IP Power Fraction (%)

(iii) Governor and associated prime mover Parameters -
Gas Turbine Units

Inlet Guide Vane Time Constant (in seconds)
Inlet Guide Vane Opening Limits (%)
Inlet Guide Vane Opening Rate Limits (%/second)
Inlet Guide Vane Closing Rate Limits (%/second)
Fuel Valve Constant (in seconds)
Fuel Valve Opening Limits (%)
Fuel Valve Opening Rate Limits (%/second)
Fuel Valve Closing Rate Limits (%/second)

Waste Heat Recovery Boiler Time Constant (in seconds)

(iv) Governor and associated prime mover Parameters -
Hydro Generating Units

Guide Vane Actuator Time Constant (in seconds)
Guide Vane Opening Limits (%)
Guide Vane Opening Rate Limits (%/second)
Guide Vane Closing Rate Limits (%/second)
Water Time Constant (in seconds)

[End of Option 2]

(e) Unit Control Options

The following data items need only be supplied with respect to **Large Power Stations**:

Maximum Droop	%
Normal Droop	%
Minimum Droop	%
Maximum Frequency deadband	±Hz
Normal Frequency deadband	±Hz
Minimum Frequency deadband	±Hz
Maximum output deadband	±MW
Normal output deadband	±MW
Minimum output deadband	±MW

Frequency settings between which Unit Load Controller **Droop** applies:

- Maximum Hz
- Normal Hz
- Minimum Hz

State if sustained response is normally selected.

(f) Plant Flexibility Performance

The following data items need only be supplied with respect to **Large Power Stations**, and should be provided with respect to each **Genset**:

- # Run-up rate to **Registered Capacity**,
- # Run-down rate from **Registered Capacity**,
- # **Synchronising Generation**,
Regulating range
Load rejection capability while still **Synchronised** and able to supply **Load**.

Data items marked with a hash (#) should be applicable to a **Genset** which has been **Shutdown** for 48 hours.

- * Data items marked with an asterisk are already requested under part 1, PC.A.3.3.1, to facilitate an early assessment by **NGET** as to whether detailed stability studies will be required before an offer of terms for a **CUSC Contract** can be made. Such data items have been repeated here merely for completeness and need not, of course, be resubmitted unless their values, known or estimated, have changed.

PC.A.5.4 **Non-Synchronous Generating Unit and Associated Control System Data**

PC.A.5.4.1 The data submitted below are not intended to constrain any **Ancillary Services Agreement**

PC.A.5.4.2 The following **Power Park Unit**, **Power Park Module** and **Power Station** data should be supplied in the case of a **Power Park Module** not connected to the **Total System** by a **DC Converter**:

(a) **Power Park Unit** model

A mathematical model of each type of **Power Park Unit** capable of representing its transient and dynamic behaviour under both small and large disturbance conditions. The model shall include non-linear effects and represent all equipment relevant to the dynamic performance of the **Power Park Unit** as agreed with **NGET**. The model shall be suitable for the study of balanced, root mean square, positive phase sequence time-domain behaviour, excluding the effects of electromagnetic transients, harmonic and sub-harmonic frequencies.

The model shall accurately represent the overall performance of the **Power Park Unit** over its entire operating range including that which is inherent to the **Power Park Unit** and that which is achieved by use of supplementary control systems providing either continuous or stepwise control. Model resolution should be sufficient to accurately represent **Power Park Unit** behaviour both in response to operation of transmission system protection and in the context of longer-term simulations.

The overall structure of the model shall include:

- (i) any supplementary control signal modules not covered by (c), (d) and (e) below.
- (ii) any blocking, deblocking and protective trip features that are part of the **Power Park Unit** (e.g. "crowbar").
- (iii) any other information required to model the **Power Park Unit** behaviour to meet the model functional requirement described above.

The model shall be submitted in the form of a transfer function block diagram and may be accompanied by dynamic and algebraic equations. This model shall display all the transfer functions and their parameter values, any non wind-up logic, signal limits and non-linearities.

The submitted **Power Park Unit** model shall have been validated and this shall be confirmed by the **Generator**. The validation shall be based on comparing the submitted model simulation results against measured test results. Validation evidence shall also be submitted and this shall include the simulation and measured test results. The latter shall include appropriate short-circuit tests.

(b) **Power Park Unit** parameters

- * Rated MVA
- * **Rated MW**
- * Rated terminal voltage
- * Inertia constant (MWsec/MVA) at synchronous speed
Additionally, for **Power Park Units** that are squirrel-cage or doubly-fed induction generators driven by wind turbines:
 - * Stator resistance
 - * Stator reactance
 - * Magnetising reactance.
 - * Rotor resistance.(at starting)
 - * Rotor resistance.(at rated running)
 - * Rotor reactance (at starting)
 - * Rotor reactance (at rated running)
 - * Inertia constant (MWsec/MVA) of the wind turbine rotor
 - * Inertia constant (MWsec/MVA) of the generator rotor
 - * Shaft stiffness (Nm/electrical radian)

Additionally for doubly-fed induction generators only:

- The generator rotor speed range (minimum and maximum speeds in RPM)
- The optimum generator rotor speed versus wind speed submitted in tabular format

Power converter rating (MVA)

The rotor power coefficient (C_p) versus tip speed ratio (λ) curves for a range of blade angles (where applicable) together with the corresponding values submitted in tabular format. The tip speed ratio (λ) is defined as $\Omega R/U$ where Ω is the angular velocity of the rotor, R is the radius of the wind turbine rotor and U is the wind speed.

The electrical power output versus generator rotor speed for a range of wind speeds over the entire operating range of the **Power Park Unit**, together with the corresponding values submitted in tabular format.

The blade angle versus wind speed curve together with the corresponding values submitted in tabular format.

The electrical power output versus wind speed over the entire operating range of the **Power Park Unit**, together with the corresponding values submitted in tabular format.

Transfer function block diagram, including parameters and description of the operation of the power electronic converter (where applicable).

For a **Power Park Unit** consisting of a synchronous machine in combination with a back to back **DC Converter**, or for a **Power Park Unit** not driven by a wind turbine, the data to be supplied shall be agreed with **NGET** in accordance with PC.A.7.

- (c) Torque / speed and blade angle control systems and parameters

For the **Power Park Unit**, details of the torque / speed controller and blade angle controller in the case of a wind turbine and power limitation functions (where applicable) described in block diagram form showing transfer functions and parameters of individual elements.

- (d) Voltage/**Reactive Power/Power Factor** control system parameters

For the **Power Park Unit** and **Power Park Module** details of voltage/**Reactive Power/Power Factor** controller (and **PSS** if fitted) described in block diagram form showing transfer functions and parameters of individual elements.

- (e) **Frequency** control system parameters

For the **Power Park Unit** and **Power Park Module** details of the **Frequency** controller described in block diagram form showing transfer functions and parameters of individual elements.

- (f) Protection

Details of settings for the following protection relays (to include):
Under **Frequency**, over **Frequency**, under voltage, over voltage, rotor over current, stator over current, high wind speed shut down level.

- (g) Complete **Power Park Unit** model, parameters and controls

An alternative to PC.A.5.4.2 (a), (b), (c), (d), (e) and (f), is the submission of a single complete model that consists of the full information required under PC.A.5.4.2 (a), (b), (c), (d), (e) and (f) provided that all the information required under PC.A.5.4.2 (a), (b), (c), (d), (e) and (f) individually is clearly identifiable.

- (h) Harmonic and flicker parameters

When connecting a **Power Park Module**, it is necessary for **NGET** to evaluate the production of flicker and harmonics on **NGET** and **User's Systems**. At **NGET's** reasonable request, the **User** is required to submit the following data (as defined in IEC 61400-21 (2001)) for each **Power Park Unit**:-

Flicker coefficient for continuous operation.

Flicker step factor.

Number of switching operations in a 10 minute window.

Number of switching operations in a 2 hour window.

Voltage change factor.

Current Injection at each harmonic for each **Power Park Unit** and for each **Power Park Module**

* Data items marked with an asterisk are already requested under part 1, PC.A.3.3.1, to facilitate an early assessment by **NGET** as to whether detailed stability studies will be required before an offer of terms for a **CUSC Contract** can be made. Such data items have been repeated here merely for completeness and need not, of course, be resubmitted unless their values, known or estimated, have changed.

PC.A.5.4.3

DC Converter

PC.A.5.4.3.1

For a **DC Converter** at a **DC Converter Station** or a **Power Park Module** connected to the **Total System** by a **DC Converter** the following information for each **DC Converter** and **DC Network** should be supplied:

- (a) **DC Converter** parameters
- * **Rated MW** per pole for transfer in each direction;
 - * **DC Converter** type (i.e. current or voltage source);
 - * Number of poles and pole arrangement;
 - * Rated DC voltage/pole (kV);
 - * Return path arrangement;
- (b) **DC Converter** transformer parameters
- Rated MVA
 - Nominal primary voltage (kV);

Nominal secondary (converter-side) voltage(s) (kV);
Winding and earthing arrangement;
Positive phase sequence reactance at minimum, maximum and nominal tap;
Positive phase sequence resistance at minimum, maximum and nominal tap;
Zero phase sequence reactance;
Tap-changer range in %;
number of tap-changer steps;

- (c) **DC Network** parameters
Rated DC voltage per pole;
Rated DC current per pole;
Single line diagram of the complete **DC Network**;
Details of the complete **DC Network**, including resistance, inductance and capacitance of all DC cables and/or DC lines;
Details of any DC reactors (including DC reactor resistance), DC capacitors and/or DC-side filters that form part of the **DC Network**;

- (d) AC filter reactive compensation equipment parameters

Note: The data provided pursuant to this paragraph must not include any contribution from reactive compensation plant owned by **NGET**.

Total number of AC filter banks.

Type of equipment (e.g. fixed or variable)

Single line diagram of filter arrangement and connections;

Reactive Power rating for each AC filter bank, capacitor bank or operating range of each item of reactive compensation equipment, at rated voltage;

Performance chart showing **Reactive Power** capability of the **DC Converter**, as a function of MW transfer, with all filters and reactive compensation plant, belonging to the **DC Converter Station** working correctly.

Note: Details in PC.A.5.4.3.1 are required for each **DC Converter** connected to the **DC Network**, unless each is identical or where the data has already been submitted for an identical **DC Converter** at another **Connection Point**.

Note: For a **Power Park Module** connected to the **Grid Entry point** or (**User System Entry Point** if **Embedded**) by a **DC Converter** the equivalent inertia and fault infeed at the **Power Park Unit** should be given.

DC Converter control system models

PC.A.5.4.3.2

The following data is required by **NGET** to represent **DC Converters** and associated **DC Networks** in dynamic power system simulations, in which the AC power system is typically represented by a positive sequence

equivalent. **DC Converters** are represented by simplified equations and are not modeled to switching device level.

- (i) Static $V_{DC}-I_{DC}$ (DC voltage - DC current) characteristics, for both the rectifier and inverter modes for a current source converter. Static $V_{DC}-P_{DC}$ (DC voltage - DC power) characteristics, for both the rectifier and inverter modes for a voltage source converter. Transfer function block diagram including parameters representation of the control systems of each **DC Converter** and of the **DC Converter Station**, for both the rectifier and inverter modes. A suitable model would feature the **DC Converter** firing angle as the output variable.
- (ii) Transfer function block diagram representation including parameters of the **DC Converter** transformer tap changer control systems, including time delays
- (iii) Transfer function block diagram representation including parameters of AC filter and reactive compensation equipment control systems, including any time delays.
- (iv) Transfer function block diagram representation including parameters of any **Frequency** and/or load control systems.
- (v) Transfer function block diagram representation including parameters of any small signal modulation controls such as power oscillation damping controls or sub-synchronous oscillation damping controls, that have not been submitted as part of the above control system data
- (vi) Transfer block diagram representation of the **Reactive Power** control at converter ends for a voltage source converter.

Plant Flexibility Performance

PC.A.5.4.3.3 The following information on plant flexibility and performance should be supplied:

- (i) Nominal and maximum (emergency) loading rate with the **DC Converter** in rectifier mode.
- (ii) Nominal and maximum (emergency) loading rate with the **DC Converter** in inverter mode.
- (iii) Maximum recovery time, to 90% of pre-fault loading, following an AC system fault or severe voltage depression.
- (iv) Maximum recovery time, to 90% of pre-fault loading, following a transient **DC Network** fault.

PC.A.5.4.3.4 Harmonic Assessment Information

DC Converter owners shall provide such additional further information as required by **NET** in order that compliance with CC.6.1.5 can be demonstrated.

- * Data items marked with an asterisk are already requested under part 1, PC.A.3.3.1, to facilitate an early assessment by **NET** as to whether detailed stability studies will be required before an offer of terms for a **CUSC Contract** can be made. Such data items have been repeated here merely for completeness and need not, of course, be resubmitted unless their values, known or estimated, have changed.

PC.A.5.5 Response data for **Frequency** changes

The information detailed below is required to describe the actual frequency response capability profile as illustrated in Figure CC.A.3.1 of the **Connection Conditions**, and need only be provided for each **Genset** at a **Large Power Stations**.

In this **PC.A.5.5**, for a **CCGT Module** with more than one **Generating Unit**, the phrase **Minimum Generation** applies to the entire **CCGT Module** operating with all **Generating Units Synchronised** to the **System**. Similarly for a **Power Park Module** with more than one **Power Park Unit**, the phrase **Minimum Generation** applies to the entire **Power Park Module** operating with all **Power Park Units Synchronised** to the **System**.

PC.A.5.5.1 MW loading points at which data is required

Response values are required at six MW loading points (MLP1 to MLP6) for each **Genset**. **Primary** and **Secondary Response** values need not be provided for MW loading points which are below **Minimum Generation**. MLP1 to MLP6 must be provided to the nearest MW.

Prior to the **Genset** being first **Synchronised**, the MW loading points must take the following values :-

MLP1	Designed Minimum Operating Level
MLP2	Minimum Generation
MLP3	70% of Registered Capacity
MLP4	80% of Registered Capacity
MLP5	95% of Registered Capacity
MLP6	Registered Capacity

When data is provided after the **Genset** is first **Synchronised**, the MW loading points may take any value between **Designed Minimum Operating Level** and **Registered Capacity** but the value of the **Designed Minimum Operating Level** must still be provided if it does not form one of the MW loading points.

PC.A.5.5.2 **Primary and Secondary Response to Frequency fall**

Primary and **Secondary Response** values for a -0.5Hz ramp are required at six MW loading points (MLP1 to MLP6) as detailed above

PC.A.5.5.3 **High Frequency Response to Frequency rise**

High Frequency Response values for a +0.5Hz ramp are required at six MW loading points (MLP1 to MLP6) as detailed above.

PC.A.5.6 **Mothballed Generating Unit Mothballed Power Park Module or Mothballed DC Converter at a DC Converter Station and Alternative Fuel Information**

Data identified under this section PC.A.5.5 must be submitted as required under PC.A.1.2 and at **NGET**'s reasonable request.

PC.A.5.6.1 **Mothballed Generating Unit Information**

Generators and **DC Converter Station** owners must supply with respect to each **Mothballed Generating Unit, Mothballed Power Park Module or Mothballed DC Converter** at a **DC Converter Station** the estimated MW output which could be returned to service within the following time periods from the time that a decision to return was made:

< 1 month;

1-2 months;

2-3 months;

3-6 months;

6-12 months; and

>12 months.

The return to service time should be determined in accordance with **Good Industry Practice** assuming normal working arrangements and normal plant procurement lead times. The MW output values should be the incremental values made available in each time period as further described in the **DRC**.

PC.A.5.6.2 **Generators** and **DC Converter Station** owners must also notify **NGET** of any significant factors which may prevent the **Mothballed Generating Unit, Mothballed Power Park Module or Mothballed DC Converter** at a **DC Converter Station** achieving the estimated values provided under PC.A.5.6.1 above, excluding factors relating to **Transmission Entry Capacity**.

PC.A.5.6.3 **Alternative Fuel Information**

The following data items must be supplied with respect to each **Generating Unit** whose main fuel is gas.

For each alternative fuel type (if facility installed):

(a) Alternative fuel type e.g. oil distillate, alternative gas supply

(b) For the changeover from main to alternative fuel:

- Time to carry out off-line and on-line fuel changeover (minutes).
- Maximum output following off-line and on-line changeover (MW).
- Maximum output during on-line fuel changeover (MW).
- Maximum operating time at full load assuming typical and maximum possible stock levels (hours).
- Maximum rate of replacement of depleted stocks (MWh electrical/day) on the basis of **Good Industry Practice**.
- Is changeover to alternative fuel used in normal operating arrangements?
- Number of successful changeovers carried out in the last **NGET Financial Year** (choice of 0, 1-5, 6-10, 11-20, >20).

(c) For the changeover back to main fuel:

- Time to carry out off-line and on-line fuel changeover (minutes).
- Maximum output during on-line fuel changeover (MW).

PC.A.5.6.4 **Generators** must also notify **NGET** of any significant factors and their effects which may prevent the use of alternative fuels achieving the estimated values provided under PC.A.5.6.3 above (e.g. emissions limits, distilled water stocks etc.)

PC.A.6 **USERS' SYSTEM DATA**

PC.A.6.1 **Introduction**

PC.A.6.1.1 Each **User**, whether connected directly via an existing **Connection Point** to the **GB Transmission System** or seeking such a direct connection, shall provide **NGET** with data on its **User System** which relates to the **Connection Site** containing the **Connection Point** both current and forecast, as specified in PC.A.6.2 to PC.A.6.6.

PC.A.6.1.2 Each **User** must reflect the system effect at the **Connection Site(s)** of any third party **Embedded** within its **User System** whether existing or proposed.

PC.A.6.1.3 PC.A.6.2, and PC.A.6.4 to PC.A.6.6 consist of data which is only to be supplied to **NGET** at **NGET's** reasonable request. In the event that **NGET** identifies a reason for requiring this data, **NGET** shall write to the relevant **User(s)**, requesting the data, and explaining the reasons for the request. If the **User(s)** wishes, **NGET** shall also arrange a meeting at which the

request for data can be discussed, with the objective of identifying the best way in which **NGET**'s requirements can be met.

PC.A.6.2 Transient Overvoltage Assessment Data

PC.A.6.2.1 It is occasionally necessary for **NGET** to undertake transient overvoltage assessments (e.g. capacitor switching transients, switchgear transient recovery voltages, etc). At **NGET**'s reasonable request, each **User** is required to provide the following data with respect to the **Connection Site**, current and forecast, together with a **Single Line Diagram** where not already supplied under PC.A.2.2.1, as follows:-

- (a) busbar layout plan(s), including dimensions and geometry showing positioning of any current and voltage transformers, through bushings, support insulators, disconnectors, circuit breakers, surge arresters, etc. Electrical parameters of any associated current and voltage transformers, stray capacitances of wall bushings and support insulators, and grading capacitances of circuit breakers;
- (b) Electrical parameters and physical construction details of lines and cables connected at that busbar. Electrical parameters of all plant e.g., transformers (including neutral earthing impedance or zig-zag transformers, if any), series reactors and shunt compensation equipment connected at that busbar (or to the tertiary of a transformer) or by lines or cables to that busbar;
- (c) Basic insulation levels (BIL) of all **Apparatus** connected directly, by lines or by cables to the busbar;
- (d) characteristics of overvoltage **Protection** devices at the busbar and at the termination points of all lines, and all cables connected to the busbar;
- (e) fault levels at the lower voltage terminals of each transformer connected directly or indirectly to the **GB Transmission System** without intermediate transformation;
- (f) the following data is required on all transformers operating at **Supergrid Voltage** throughout **Great Britain** and, in Scotland, also at 132kV: three or five limb cores or single phase units to be specified, and operating peak flux density at nominal voltage;
- (g) an indication of which items of equipment may be out of service simultaneously during **Planned Outage** conditions.

PC.A.6.3 User's Protection Data

PC.A.6.3.1 Protection

The following information is required which relates only to **Protection** equipment which can trip or inter-trip or close any **Connection Point**

circuit-breaker or any **Transmission** circuit-breaker. This information need only be supplied once, in accordance with the timing requirements set out in PC.A.1.4(b), and need not be supplied on a routine annual basis thereafter, although **NGET** should be notified if any of the information changes

- (a) a full description, including estimated settings, for all relays and **Protection** systems installed or to be installed on the **User's System**;
- (b) a full description of any auto-reclose facilities installed or to be installed on the **User's System**, including type and time delays;
- (c) a full description, including estimated settings, for all relays and **Protection** systems or to be installed on the generator, generator transformer, **Station Transformer** and their associated connections;
- (d) for **Generating Units** (other than **Power Park Units**) or **Power Park Modules** or **DC Converters** at a **DC Converter Station** having (or intended to have) a circuit breaker at the generator terminal voltage, clearance times for electrical faults within the **Generating Unit** (other than a **Power Park Unit**) or **Power Park Module** zone;
- (e) the most probable fault clearance time for electrical faults on any part of the **User's System** directly connected to the **GB Transmission System**.

PC.A.6.4 Harmonic Studies

PC.A.6.4.1 It is occasionally necessary for **NGET** to evaluate the production/magnification of harmonic distortion on **NGET** and **User's Systems**, especially when **NGET** is connecting equipment such as capacitor banks. At **NGET's** reasonable request, each **User** is required to submit data with respect to the **Connection Site**, current and forecast, and where not already supplied under PC.A.2.2.4 and PC.A.2.2.5, as follows:-

PC.A.6.4.2 Overhead lines and underground cable circuits of the **User's Subtransmission System** must be differentiated and the following data provided separately for each type:-

- Positive phase sequence resistance;
- Positive phase sequence reactance;
- Positive phase sequence susceptance;

and for all transformers connecting the **User's Subtransmission System** to a lower voltage:-

- Rated MVA;
- Voltage Ratio;
- Positive phase sequence resistance;

Positive phase sequence reactance;

and at the lower voltage points of those connecting transformers:-

Equivalent positive phase sequence susceptance;
Connection voltage and Mvar rating of any capacitor bank and component design parameters if configured as a filter;
Equivalent positive phase sequence interconnection impedance with other lower voltage points;
The minimum and maximum **Demand** (both MW and Mvar) that could occur;
Harmonic current injection sources in Amps at the Connection voltage points. Where the harmonic injection current comes from a diverse group of sources, the equivalent contribution may be established from appropriate measurements;
Details of traction loads, eg connection phase pairs, continuous variation with time, etc;
An indication of which items of equipment may be out of service simultaneously during **Planned Outage** conditions.

PC.A.6.5

Voltage Assessment Studies

It is occasionally necessary for **NGET** to undertake detailed voltage assessment studies (e.g., to examine potential voltage instability, voltage control co-ordination or to calculate voltage step changes). At **NGET's** reasonable request, each **User** is required to submit the following data where not already supplied under PC.A.2.2.4 and PC.A.2.2.5:-

For all circuits of the **User's Subtransmission System**:-

Positive Phase Sequence Reactance;
Positive Phase Sequence Resistance;
Positive Phase Sequence Susceptance;
Mvar rating of any reactive compensation equipment;

and for all transformers connecting the **User's Subtransmission System** to a lower voltage:-

Rated MVA;
Voltage Ratio;
Positive phase sequence resistance;
Positive Phase sequence reactance;
Tap-changer range;
Number of tap steps;
Tap-changer type: on-load or off-circuit;
AVC/tap-changer time delay to first tap movement;
AVC/tap-changer inter-tap time delay;

and at the lower voltage points of those connecting transformers:-

Equivalent positive phase sequence susceptance;
Mvar rating of any reactive compensation equipment;
Equivalent positive phase sequence interconnection impedance with other lower voltage points;

The maximum **Demand** (both MW and Mvar) that could occur;
Estimate of voltage insensitive (constant power) load content in
% of total load at both winter peak and 75% off-peak load
conditions.

PC.A.6.6 Short Circuit Analysis:

PC.A.6.6.1 Where prospective short-circuit currents on equipment owned, operated or managed by **NGET** are greater than 90% of the equipment rating, and in **NGET**'s reasonable opinion more accurate calculations of short-circuit currents are required, then at **NGET**'s request each **User** is required to submit data with respect to the **Connection Site**, current and forecast, and where not already supplied under PC.A.2.2.4 and PC.A.2.2.5, as follows:

PC.A.6.6.2 For all circuits of the **User's Subtransmission System**:-

Positive phase sequence resistance;
Positive phase sequence reactance;
Positive phase sequence susceptance;
Zero phase sequence resistance (both self and mutuals);
Zero phase sequence reactance (both self and mutuals);
Zero phase sequence susceptance (both self and mutuals);

and for all transformers connecting the **User's Subtransmission System** to a lower voltage:-

Rated MVA;
Voltage Ratio;
Positive phase sequence resistance (at max, min and nominal tap);
Positive Phase sequence reactance (at max, min and nominal tap);
Zero phase sequence reactance (at nominal tap);
Tap changer range;
Earthing method: direct, resistance or reactance;
Impedance if not directly earthed;

and at the lower voltage points of those connecting transformers:-

The maximum **Demand** (in MW and Mvar) that could occur;
Short-circuit infeed data in accordance with PC.A.2.5.6 unless the **User's** lower voltage network runs in parallel with the **User's Subtransmission System**, when to prevent double counting in each node infeed data, a π equivalent comprising the data items of PC.A.2.5.6 for each node together with the positive phase sequence interconnection impedance between the nodes shall be submitted.

PC.A.7 ADDITIONAL DATA FOR NEW TYPES OF POWER STATIONS, DC CONVERTER STATIONS AND CONFIGURATIONS

Notwithstanding the **Standard Planning Data** and **Detailed Planning Data** set out in this Appendix, as new types of configurations and

operating arrangements of **Power Stations** and **DC Converter Stations** emerge in future, **NGET** may reasonably require additional data to represent correctly the performance of such **Plant** and **Apparatus** on the **System**, where the present data submissions would prove insufficient for the purpose of producing meaningful **System** studies for the relevant parties.

PART 3

NETWORK DATA

PC.A.8 To allow a **User** to model the **GB Transmission System**, **NGET** will provide the following **Network Data** to **Users**, calculated in accordance with **Good Industry Practice**:-

PC.A.8.1 Single Point of Connection

For a **Single Point of Connection** to a **User's System**, as an equivalent 400kV or 275kV source and also in Scotland as an equivalent 132kV source, the data (as at the HV side of the **Point of Connection** reflecting data given to **NGET** by **Users**) will be given to a **User** as follows:-

The data items listed under the following parts of PC.A.8.3:-

(a) (i), (ii), (iii), (iv), (v) and (vi)

and the data items shall be provided in accordance with the detailed provisions of PC.A.8.3 (b) - (e).

PC.A.8.2 Multiple Point of Connection

For a **Multiple Point of Connection** to a **User's System**, the equivalent will normally be in the form of a π model or extension with a source at each node and a linking impedance. The data at the **Connection Point** will be given to a **User** as follows:-

The data items listed under the following parts of PC.A.8.3:-

(a) (i), (ii), (iv), (v), (vi), (vii) and (viii)

and the data items shall be provided in accordance with the detailed provisions of PC.A.8.3 (b) - (e).

When an equivalent of this form is not required **NGET** will not provide the data items listed under the following parts of PC.A.8.3:-

(a) (vii) and (viii)

PC.A.8.3 Data Items

(a) The following is a list of data utilised in this part of the **PC**. It also contains rules on the data which generally apply.

(i) symmetrical three-phase short circuit current infeed at the instant of fault from the **GB Transmission System**, (I_1'');

(ii) symmetrical three-phase short circuit current from the **GB Transmission System** after the subtransient fault current contribution has substantially decayed, (I_1');

- (iii) the zero sequence source resistance and reactance values at the **Point of Connection**, consistent with the maximum infeed below;
 - (iv) the pre-fault voltage magnitude at which the maximum fault currents were calculated;
 - (v) the positive sequence X/R ratio at the instant of fault;
 - (vi) the negative sequence resistance and reactance values of the **GB Transmission System** seen from the **Point of Connection**, if substantially different from the values of positive sequence resistance and reactance which would be derived from the data provided above;
 - (vii) the initial positive sequence resistance and reactance values of the two (or more) sources and the linking impedance(s) derived from a fault study constituting the (π) equivalent and evaluated without the **User** network and load and;
 - (viii) the corresponding zero sequence impedance values of the (π) equivalent.
- (b) To enable the model to be constructed, **NGET** will provide data based on the following conditions.
- (c) The initial symmetrical three phase short circuit current and the transient period three phase short circuit current will normally be derived from the fixed impedance studies. The latter value should be taken as applying at times of 120ms and longer. Shorter values may be interpolated using a value for the subtransient time constant of 40ms. These fault currents will be obtained from a full **System** study based on load flow analysis that takes into account any existing flow across the point of connection being considered.
- (d) Since the equivalent will be produced for the 400kV or 275kV and also in Scotland 132kV parts of the **GB Transmission System** **NGET** will provide the appropriate supergrid transformer data.
- (e) The positive sequence X/R ratio and the zero sequence impedance value will correspond to the **NGET** source network only, that is with the section of network if any with which the equivalent is to be used excluded. These impedance values will be derived from the condition when all **Generating Units** are **Synchronised** to the **GB Transmission System** or a **User's System** and will take account of active sources only including any contribution from the load to the fault current. The passive component of the load itself or other system shunt impedances should not be included.
- (f) A **User** may at any time, in writing, specifically request for an equivalent to be prepared for an alternative **System** condition, for example where the **User's System** peak does not correspond to the **GB Transmission System** peak, and **NGET** will, insofar as such request is reasonable,

provide the information as soon as reasonably practicable following the request.

PLANNING CODE APPENDIX B

Single Line Diagram

The diagrams below show three examples of single line diagrams, showing the detail that should be incorporated in the diagram. The first example is for an **Network Operator** connection, the second for a **Generator** connection, the third for a **Power Park Module** electrically equivalent system.

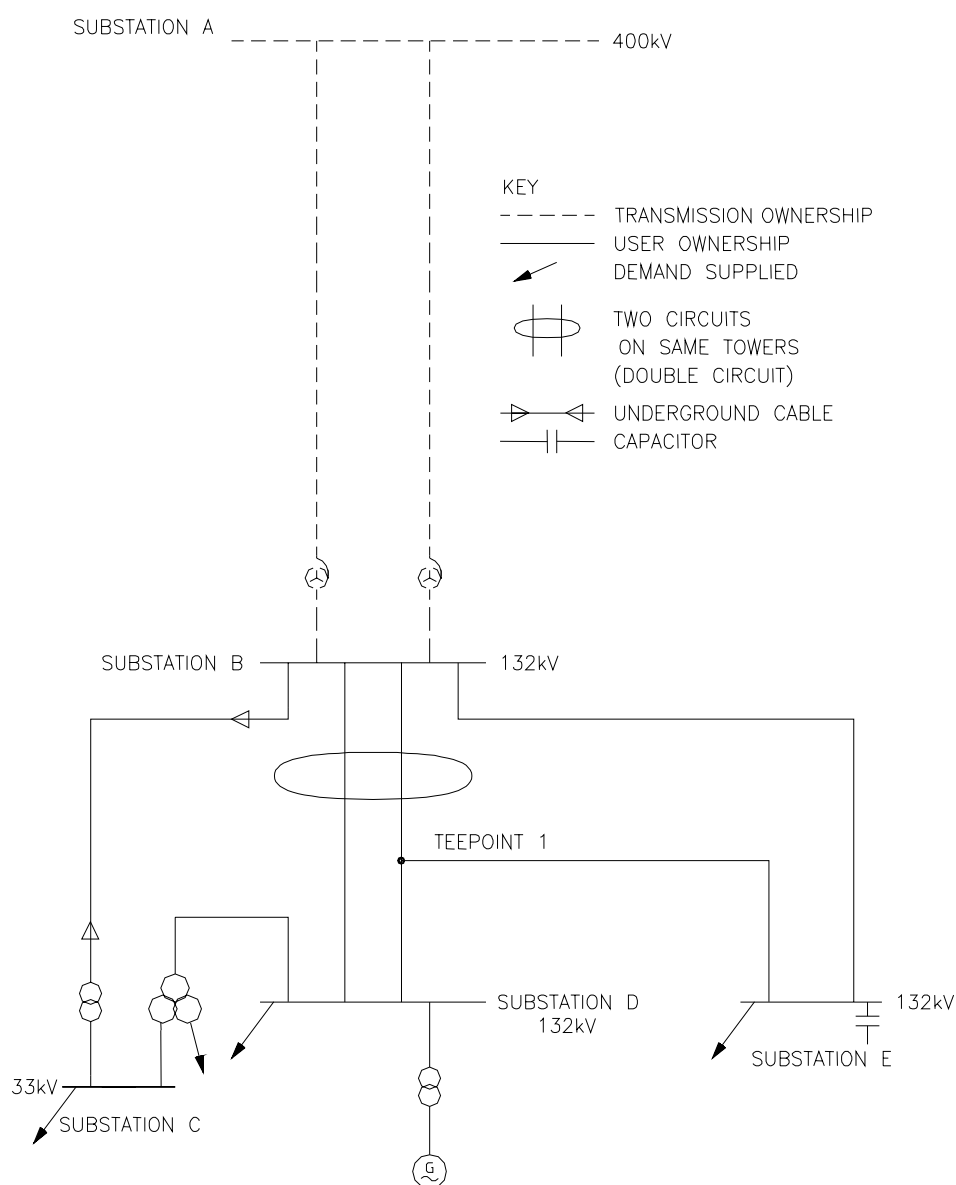

UNCONTROLLED COPY
NOT SUBJECT TO
REVISION SERVICES

ISS. D
41/18826_1_1 29-07-04

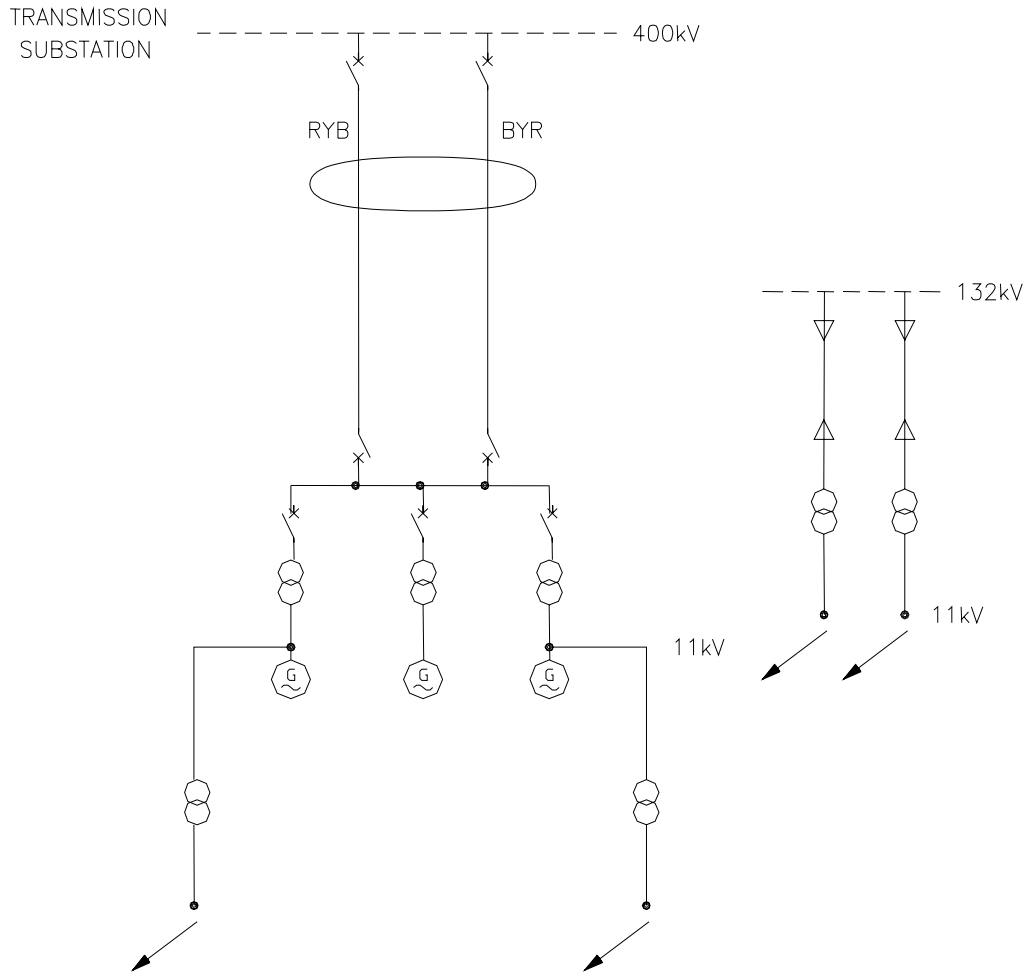

- KEY
- TRANSMISSION OWNERSHIP
 - USER OWNERSHIP
 - ↙ DEMAND SUPPLIED
 - ⊖ ⊖ TWO CIRCUITS ON SAME TOWERS (DOUBLE CIRCUIT)
 - ▷ ◁ UNDERGROUND CABLE

UNCONTROLLED COPY
NOT SUBJECT TO
REVISION SERVICES G

41/19468_1_1 ISS D
29-07-04

Power Park Module Single Line Diagram

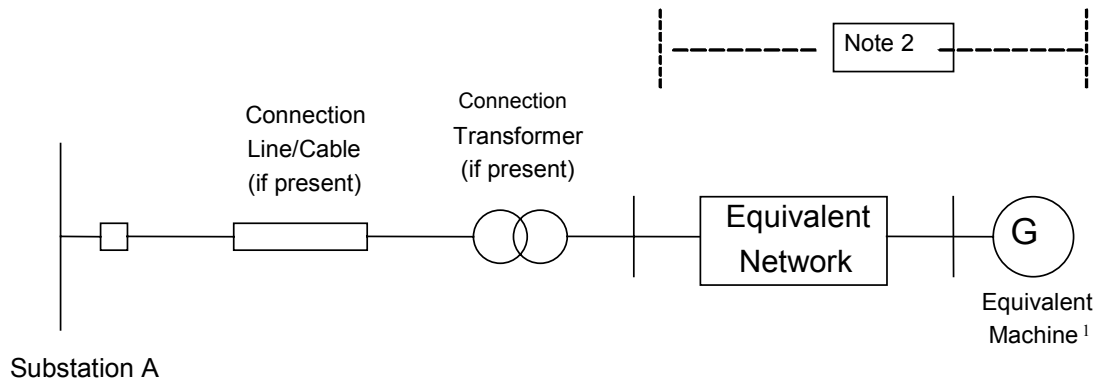

- Notes :
- 1) It is recommended that this consists of 'N' actual generators i.e. any equipment external to the generator terminals is considered as part of the Equivalent Network
 - 2) Where a Power Park Module consists of different Power Park Units, the equivalent machine and network can be repeated for each different unit

PLANNING CODE APPENDIX C

- C1.1 Planning and design of the **SPT** and **SHETL Transmission Systems** is based generally, but not totally, on criteria which evolved from joint consultation among various **Transmission Licensees** responsible for design of the **GB Transmission System**.
- C1.2 The above criteria are set down within the standards, memoranda, recommendations and reports and are provided as a guide to system planning. It should be noted that each scheme for reinforcement or modification of the **Transmission System** is individually designed in the light of economic and technical factors associated with the particular system limitations under consideration.
- C1.3 The tables below identify the literature referred to above, together with the main topics considered within each document.

PART 1 – SHETL's TECHNICAL AND DESIGN CRITERIA

ITEM No.	DOCUMENT	REFERENCE No.
1	GB Security and Quality of Supply Standard	Version 1
2	System Phasing	TPS 13/4
3	not used	
4	Planning Limits for Voltage Fluctuations Caused by Industrial, Commercial and Domestic Equipment in the United Kingdom	ER P28
5	EHV or HV Supplies to Induction Furnaces Voltage unbalance limits. Harmonic current limits.	ER P16 (Supported by ACE Report No.48)
6	Planning Levels for Harmonic Voltage Distortion and the Connection of Non-Linear Loads to Transmission Systems and Public Electricity Supply Systems in the United Kingdom Harmonic distortion (waveform). Harmonic voltage distortion. Harmonic current distortion. Stage 1 limits. Stage 2 limits. Stage 3 Limits Addition of Harmonics Short Duration Harmonics Site Measurements	ER G5/4 (Supported by ACE Report No.73)

ITEM No.	DOCUMENT	REFERENCE No.
7	<p>AC Traction Supplies to British Rail</p> <p>Type of supply point to railway system.</p> <p>Estimation of traction loads.</p> <p>Nature of traction current.</p> <p>System disturbance estimation.</p> <p>Earthing arrangements.</p>	ER P24
8	<p>Operational Memoranda</p> <p>Main System operating procedure.</p> <p>Operational standards of security.</p> <p>Voltage and reactive control on main system.</p> <p>System warnings and procedures for instructed load reduction.</p> <p>Continuous tape recording of system control telephone messages and instructions.</p> <p>Emergency action in the event of an exceptionally serious breakdown of the main system.</p>	<p>(SOM)</p> <p>SOM 1</p> <p>SOM 3</p> <p>SOM 4</p> <p>SOM 7</p> <p>SOM 10</p> <p>SOM 15</p>
9	Planning Limits for Voltage Unbalance in the United Kingdom.	ER P29

PART 2 – SPT's TECHNICAL AND DESIGN CRITERIA

ITEM No.	DOCUMENT	Reference No.
1	GB Security and Quality of Supply Standard	Version 1
2	System Phasing	TDM 13/10,002 Issue 4
3	not used	
4	Planning Limits for Voltage Fluctuations Caused by Industrial, Commercial and Domestic Equipment in the United Kingdom	ER P28
5	EHV or HV Supplies to Induction Furnaces Voltage Unbalance limits. Harmonic current limits.	ER P16 (Supported by ACE Report No.48)
6	Planning Levels for Harmonic Voltage Distortion and the Connection of Non-Linear Loads to Transmission Systems and Public Electricity Supply Systems in the United Kingdom Harmonic distortion (waveform). Harmonic voltage distortion. Harmonic current distortion. Stage 1 limits. Stage 2 limits. Stage 3 Limits Addition of Harmonics Short Duration Harmonics Site Measurements	ER G5/4 Supported by ACE Report No.73)
7	AC Traction Supplies to British Rail Type of supply point to railway system. Estimation of traction loads. Nature of traction current. System disturbance estimation. Earthing arrangements.	ER P24

< End of Planning Code (PC) >

CONNECTION CONDITIONS

CONTENTS

(This contents page does not form part of the Grid Code)

<u>Paragraph No/Title</u>	<u>Page Number</u>
CC.1 INTRODUCTION.....	1
CC.2 OBJECTIVE	1
CC.3 SCOPE	1
CC.4 PROCEDURE	1
CC.5 CONNECTION	2
CC.6 TECHNICAL, DESIGN AND OPERATIONAL CRITERIA	
CC.6.1 GB Transmission System Performance Characteristics.....	3
CC.6.2 Plant and Apparatus relating to Connection Site	
CC.6.2.1 General Requirements.....	5
CC.6.2.2 Requirements at Connection Points that relate to Generators or DC Converter Station owners	8
CC.6.2.3 Requirements. at Connection Points relating to Network Operator and Non-Embedded Customers	10
CC.6.3 General Generating Unit Requirements.....	13
CC.6.4 General Network Operator and Non-Embedded Customer Requirements	23
CC.6.5 Communications Plant.....	24
CC.6.6 System Monitoring.....	27
CC.7 SITE RELATED CONDITIONS	
CC.7.2 Responsibilities for Safety.....	27
CC.7.3 Site Responsibility Schedules.....	29
CC.7.4 Operation and Gas Zone Diagrams	29
CC.7.5 Site Common Drawings	31
CC.7.6 Access.....	32
CC.7.7 Maintenance Standards.....	33
CC.7.8 Site Operational Procedures.....	33
CC.8 ANCILLARY SERVICES	
CC.8.1 System Ancillary Services.....	34
CC.8.2 Commercial Ancillary Services.....	34
APPENDIX 1 – SITE RESPONSIBILITY SCHEDULES.....	35

APPENDIX 2 - OPERATION DIAGRAMS	43
APPENDIX 3 - MINIMUM FREQUENCY RESPONSE REQUIREMENTS.....	49
APPENDIX 4 – FAULT RIDE THROUGH REQUIREMENT	54
APPENDIX 5 - LOW FREQUENCY RELAYS.....	57

CONNECTION CONDITIONS

CC.1 INTRODUCTION

CC.1.1 The **Connection Conditions** ("CC") specify both the minimum technical, design and operational criteria which must be complied with by any **User** connected to or seeking connection with the **GB Transmission System** or **Generators** (other than in respect of **Small Power Stations**) or **DC Converter Station** owners connected to or seeking connection to a **User's System** which is located in **Great Britain**, and the minimum technical, design and operational criteria with which **NGET** will comply in relation to the part of the **GB Transmission System** at the **Connection Site** with **Users**.

CC.2 OBJECTIVE

CC.2.1 The objective of the **CC** is to ensure that by specifying minimum technical, design and operational criteria the basic rules for connection to the **GB Transmission System** and (for certain **Users**) to a **User's System** are similar for all **Users** of an equivalent category and will enable **NGET** to comply with its statutory and **Transmission Licence** obligations.

CC.3 SCOPE

CC.3.1 The **CC** applies to **NGET** and to **Users**, which in the **CC** means:

- (a) **Generators** (other than those which only have **Embedded Small Power Stations**)
- (b) **Network Operators**;
- (c) **Non-Embedded Customers**;
- (d) **DC Converter Station** owners; and
- (e) **BM Participants** and **Externally Interconnected System Operators** in respect of CC.6.5 only.

The above categories of **User** will become bound by the **CC** prior to them generating, distributing, supplying or consuming, as the case may be, and references to the various categories should, therefore, be taken as referring to them in that prospective role as well as to **Users** actually connected.

CC.4 PROCEDURE

CC.4.1 The **CUSC** contains provisions relating to the procedure for connection to the **GB Transmission System** or, in the case of **Embedded Power Stations** or **Embedded DC Converter Stations**, becoming operational and includes provisions relating to certain conditions to be complied with by **Users** prior to **NGET** notifying the **User** that it has the right to become operational.

CC.5. CONNECTION

CC.5.1 The provisions relating to connecting to the **GB Transmission System** (or to a **User's System** in the case of a connection of an **Embedded Large Power Station** or **Embedded Medium Power Station** or **Embedded DC Converter Station**) are contained in the **CUSC** and/or **CUSC Contract** (or in the relevant application form or offer for a **CUSC Contract**), and include provisions relating to both the submission of information and reports relating to compliance with the relevant **Connection Conditions** for that **User**, **Safety Rules**, commissioning programmes, **Operation Diagrams** and approval to connect. References in this **CC** to the "**Bilateral Agreement**" and/or "**Construction Agreement**" shall be deemed to include references to the application form or offer therefor.

CC.5.2 Prior to the **Completion Date** under the **Bilateral Agreement** and/or **Construction Agreement**, the following is submitted pursuant to the terms of the **Bilateral Agreement** and/or **Construction Agreement**:

- (a) updated **Planning Code** data (both **Standard Planning Data** and **Detailed Planning Data**), with any estimated values assumed for planning purposes confirmed or, where practical, replaced by validated actual values and by updated estimates for the future and by updated forecasts for **Forecast Data** items such as **Demand**, pursuant to the requirements of the **Planning Code**;
- (b) details of the **Protection** arrangements and settings referred to in CC.6;
- (c) copies of all **Safety Rules** and **Local Safety Instructions** applicable at **Users' Sites** which will be used at the **NGET/User** interface (which, for the purpose of **OC8**, must be to **NGET's** satisfaction regarding the procedures for **Isolation** and **Earthing**. For **User Sites** in Scotland **NGET** will consult the **Relevant Transmission Licensee** when determining whether the procedures for **Isolation** and **Earthing** are satisfactory);
- (d) information to enable **NGET** to prepare **Site Responsibility Schedules** on the basis of the provisions set out in Appendix 1;
- (e) an **Operation Diagram** for all **HV Apparatus** on the **User** side of the **Connection Point** as described in CC.7;
- (f) the proposed name of the **User Site** (which shall not be the same as, or confusingly similar to, the name of any **Transmission Site** or of any other **User Site**);
- (g) written confirmation that **Safety Coordinators** acting on behalf of the **User** are authorised and competent pursuant to the requirements of **OC8**;
- (h) **RISSP** prefixes pursuant to the requirements of **OC8**. **NGET** is required to circulate prefixes utilising a proforma in accordance with **OC8**;
- (i) a list of the telephone numbers for **Joint System Incidents** at which senior management representatives nominated for the purpose can be contacted and confirmation that they are fully authorised to make binding decisions on behalf of the **User**, pursuant to **OC9**;
- (j) a list of managers who have been duly authorised to sign **Site Responsibility Schedules** on behalf of the **User**;

- (k) information to enable **NGET** to prepare **Site Common Drawings** as described in CC.7;
- (l) a list of the telephone numbers for the **Users** facsimile machines referred to in CC.6.5.9; and
- (m) for **Sites** in Scotland a list of persons appointed by the **User** to undertake operational duties on the **User's System** and to issue and receive operational messages and instructions in relation to the **User's System**; and an appointed person or persons responsible for the maintenance and testing of **User's Plant** and **Apparatus**.

CC.5.3 As explained in the **Bilateral Agreement** and/or **Construction Agreement**, of the list:

- (a) items CC.5.2 (c), (e), (g), (h), (k) and (m) need not be supplied in respect of **Embedded Power Stations** or **Embedded DC Converter Stations**,
- (b) item CC.5.2(i) need not be supplied in respect of **Embedded Small Power Stations** and **Embedded Medium Power Stations** or **Embedded DC Converter Stations** with a **Registered Capacity** of less than 100MW, and
- (c) items CC.5.2(d) and (j) are only needed in the case where the **Embedded Power Station** or the **Embedded DC Converter Station** is within a **Connection Site** with another **User**.

CC.5.4 In addition, at the time the information is given under CC.5.2(g), **NGET** will provide written confirmation to the **User** that the **Safety Co-ordinators** acting on behalf of **NGET** are authorised and competent pursuant to the requirements of **OC8**.

CC.6 TECHNICAL, DESIGN AND OPERATIONAL CRITERIA

CC.6.1 GB TRANSMISSION SYSTEM PERFORMANCE CHARACTERISTICS

CC.6.1.1 **NGET** shall ensure that, subject as provided in the **Grid Code**, the **GB Transmission System** complies with the following technical, design and operational criteria in relation to the part of the **GB Transmission System** at the **Connection Site** with a **User** (unless otherwise specified in CC.6) although in relation to operational criteria **NGET** may be unable (and will not be required) to comply with this obligation to the extent that there are insufficient **Power Stations** or **User Systems** are not available or **Users** do not comply with **NGET's** instructions or otherwise do not comply with the **Grid Code** and each **User** shall ensure that its **Plant** and **Apparatus** complies with the criteria set out in CC.6.1.5.

Grid Frequency Variations

CC.6.1.2 The **Frequency** of the **GB Transmission System** shall be nominally 50Hz and shall be controlled within the limits of 49.5 - 50.5Hz unless exceptional circumstances prevail.

CC.6.1.3 The **System Frequency** could rise to 52Hz or fall to 47Hz in exceptional circumstances. Design of **User's Plant** and **Apparatus** must enable operation of that **Plant** and **Apparatus** within that range in accordance with the following:-

<u>Frequency Range</u>	<u>Requirement</u>
47.5Hz - 52Hz	Continuous operation is required
47Hz - 47.5Hz	Operation for a period of at least 20 seconds is required each time the Frequency is below 47.5Hz.

Grid Voltage Variations

CC.6.1.4 Subject as provided below, the voltage on the 400kV part of the **GB Transmission System** at each **Connection Site** with a **User** will normally remain within $\pm 5\%$ of the nominal value unless abnormal conditions prevail. The minimum voltage is -10% and the maximum voltage is +10% unless abnormal conditions prevail, but voltages between +5% and +10% will not last longer than 15 minutes unless abnormal conditions prevail. Voltages on the 275kV and 132kV parts of the **GB Transmission System** at each **Connection Site** with a **User** will normally remain within the limits $\pm 10\%$ of the nominal value unless abnormal conditions prevail. At nominal **System** voltages below 132kV the voltage of the **GB Transmission System** at each **Connection Site** with a **User** will normally remain within the limits $\pm 6\%$ of the nominal value unless abnormal conditions prevail. Under fault conditions, voltage may collapse transiently to zero at the point of fault until the fault is cleared.

NGET and a **User** may agree greater or lesser variations in voltage to those set out above in relation to a particular **Connection Site**, and insofar as a greater or lesser variation is agreed, the relevant figure set out above shall, in relation to that **User** at the particular **Connection Site**, be replaced by the figure agreed.

Voltage Waveform Quality

CC.6.1.5 All **Plant** and **Apparatus** connected to the **GB Transmission System**, and that part of the **GB Transmission System** at each **Connection Site**, should be capable of withstanding the following distortions of the voltage waveform in respect of harmonic content and phase unbalance:

(a) Harmonic Content

The **Electromagnetic Compatibility Levels** for harmonic distortion on the **GB Transmission System** from all sources under both **Planned Outage** and fault outage conditions, (unless abnormal conditions prevail) shall comply with the levels shown in the tables of Appendix A of **Engineering Recommendation G5/4**.

Engineering Recommendation G5/4 contains planning criteria which **NGET** will apply to the connection of non-linear **Load** to the **GB Transmission System**, which may result in harmonic emission limits being specified for these **Loads** in the relevant **Bilateral Agreement**. The application of the planning criteria will take into account the position of existing and prospective **Users' Plant** and **Apparatus** in relation to harmonic emissions. **Users** must ensure that connection of distorting loads to their **User Systems** do not cause any harmonic emission limits specified in the **Bilateral Agreement**, or where no such limits are specified, the relevant planning levels specified in **Engineering Recommendation G5/4** to be exceeded.

(b) Phase Unbalance

Under **Planned Outage** conditions, the maximum **Phase (Voltage) Unbalance** on the **GB Transmission System** should remain, in England and Wales, below 1%, and in Scotland, below 2%, unless abnormal conditions prevail.

CC.6.1.6 In England and Wales, under the **Planned Outage** conditions stated in CC.6.1.5(b) infrequent short duration peaks with a maximum value of 2% are permitted for **Phase (Voltage) Unbalance**, subject to the prior agreement of **NGET** under the **Bilateral Agreement**. **NGET** will only agree following a specific assessment of the impact of these levels on **Transmission Apparatus** and other **Users Apparatus** with which it is satisfied.

Voltage Fluctuations

CC.6.1.7 Voltage fluctuations at a **Point of Common Coupling** with a fluctuating **Load** directly connected to the **GB Transmission System** shall not exceed:

- (a) In England and Wales, 1% of the voltage level for step changes which may occur repetitively. Any large voltage excursions other than step changes may be allowed up to a level of 3% provided that this does not constitute a risk to the **GB Transmission System** or, in **NGET's** view, to the **System** of any **User**. In Scotland, the limits for voltage level step changes are as set out in **Engineering Recommendation P28**.
- (b) For voltages above 132kV, **Flicker Severity (Short Term)** of 0.8 Unit and a **Flicker Severity (Long Term)** of 0.6 Unit, for voltages 132kV and below, **Flicker Severity (Short Term)** of 1.0 Unit and a **Flicker Severity (Long Term)** of 0.8 Unit, as set out in **Engineering Recommendation P28** as current at the **Transfer Date**.

CC.6.2 **PLANT AND APPARATUS RELATING TO CONNECTION SITE**

The following requirements apply to **Plant** and **Apparatus** relating to the **Connection Point**, which (except as otherwise provided in the relevant paragraph) each **User** must ensure are complied with in relation to its **Plant** and **Apparatus** and which in the case of CC.6.2.2.2, CC.6.2.3.1.1 and CC.6.2.1.1(b) only, **NGET** must ensure are complied with in relation to **Transmission Plant** and **Apparatus**, as provided in those paragraphs.

CC.6.2.1 General Requirements

CC.6.2.1.1 (a) The design of connections between the **GB Transmission System** and:-

- (i) any **Generating Unit** (other than a **CCGT Unit** or **Power Park Unit**) **DC Converter, Power Park Module** or **CCGT Module**, or
- (ii) any **Network Operator's User System**, or
- (iii) **Non-Embedded Customers** equipment;

will be consistent with the **Licence Standards**.

- (b) The **GB Transmission System** at nominal **System** voltages of 132kV and above is designed to be earthed with an **Earth Fault Factor** of, in England and Wales, below 1.4 and in Scotland, below 1.5. Under fault conditions the rated **Frequency** component of voltage could fall transiently to zero on one or more phases or, in England and Wales, rise to 140% phase-to-earth voltage, or in Scotland, rise to 150% phase-to-earth voltage. The voltage rise would last only for the time that the fault conditions exist. The fault conditions referred to here are those existing when the type of fault is single or two phase-to-earth.
- (c) For connections to the **GB Transmission System** at nominal **System** voltages of below 132kV the earthing requirements and voltage rise conditions will be advised by **NGET** as soon as practicable prior to connection.

CC.6.2.1.2 Substation **Plant** and **Apparatus**

- (a) The following provisions shall apply to all **Plant** and **Apparatus** which is connected at the voltage of the **Connection Point** and which is contained in equipment bays that are within the **Transmission** busbar protection zone at the **Connection Point**. This includes circuit breakers, switch disconnectors, disconnectors, **Earthing Devices**, power transformers, voltage transformers, reactors, current transformers, surge arresters, bushings, neutral equipment, capacitors, line traps, coupling devices, external insulation and insulation co-ordination devices. Where necessary, this is as more precisely defined in the **Bilateral Agreement**.

- (i) **Plant** and/or **Apparatus** prior to 1st January 1999

Each item of such **Plant** and/or **Apparatus** which at 1st January 1999 is either :-

- installed; or
- owned (but is either in storage, maintenance or awaiting installation); or
- ordered

and is the subject of a **Bilateral Agreement** with regard to the purpose for which it is in use or intended to be in use, shall comply with the relevant standards/specifications applicable at the time that the **Plant** and/or **Apparatus** was designed (rather than commissioned) and any further requirements as specified in the **Bilateral Agreement**.

- (ii) **Plant** and/or **Apparatus** post 1st January 1999 for a new **Connection Point**

Each item of such **Plant** and/or **Apparatus** installed in relation to a new **Connection Point** after 1st January 1999 shall comply with the relevant

Technical Specifications and any further requirements identified by **NGET**, acting reasonably, to reflect the options to be followed within the **Technical Specifications** and/or to complement if necessary the **Technical Specifications** so as to enable **NGET** to comply with its obligations in relation to the **GB Transmission System** or, in Scotland, also the **Relevant Transmission Licensee** to comply with its obligations in relation to its **Transmission System**. This information, including the application dates of the relevant **Technical Specifications**, will be as specified in the **Bilateral Agreement**.

(iii) New **Plant** and/or **Apparatus** post 1st January 1999 for an existing **Connection Point**

Each new additional and/or replacement item of such **Plant** and/or **Apparatus** installed in relation to a change to an existing **Connection Point** after 1st January 1999 shall comply with the standards/specifications applicable when the change was designed, or such other standards/specifications as necessary to ensure that the item of **Plant** and/or **Apparatus** is reasonably fit for its intended purpose having due regard to the obligations of **NGET**, the relevant **User** and, in Scotland, also the **Relevant Transmission Licensee** under their respective **Licences**. Where appropriate this information, including the application dates of the relevant standards/specifications, will be as specified in the varied **Bilateral Agreement**.

(iv) Used **Plant** and/or **Apparatus** being moved, re-used or modified

If, after its installation, any such item of **Plant** and/or **Apparatus** is subsequently:-

- moved to a new location; or
- used for a different purpose; or
- otherwise modified;

then the standards/specifications as described in (i), (ii), or (iii) above as applicable will apply as appropriate to such **Plant** and/or **Apparatus**, which must be reasonably fit for its intended purpose having due regard to the obligations of **NGET**, the relevant **User** and, in Scotland, also the **Relevant Transmission Licensee** under their respective **Licences**.

- (b) **NGET** shall at all times maintain a list of those **Technical Specifications** and additional requirements which might be applicable under this CC.6.2.1.2 and which may be referenced by **NGET** in the **Bilateral Agreement**. **NGET** shall provide a copy of the list upon request to any **User**. **NGET** shall also provide a copy of the list to any new **User** upon receipt of an application form for a **Bilateral Agreement** for a new **Connection Point**.
- (c) Where the **User** provides **NGET** with information and/or test reports in respect of **Plant** and/or **Apparatus** which the **User** reasonably believes demonstrate the compliance of such items with the provisions of a **Technical Specification** then **NGET** shall promptly and without unreasonable delay give due and proper consideration to such information.
- (d) **Plant** and **Apparatus** shall be designed, manufactured and tested in premises with an accredited certificate in accordance with the quality assurance requirements of the relevant standard in the BS EN ISO 9000 series (or equivalent as reasonably approved by **NGET**) or in respect of test

premises which do not include a manufacturing facility premises with an accredited certificate in accordance with BS EN 45001.

- (e) Each connection between a **User** and the **GB Transmission System** must be controlled by a circuit-breaker (or circuit breakers) capable of interrupting the maximum short circuit current at the point of connection. The **Seven Year Statement** gives values of short circuit current and the rating of **Transmission** circuit breakers at existing and committed **Connection Points** for future years.

CC.6.2.2 Requirements at **Connection Points** that relate to **Generators** or **DC Converter Station** owners

CC.6.2.2.1 Not Used.

CC.6.2.2.2 **Generating Unit** and **Power Station Protection** Arrangements

CC.6.2.2.2.1 Minimum Requirements

Protection of Generating Units (other than **Power Park Units**), **DC Converters** or **Power Park Modules** and their connections to the **GB Transmission System** must meet the minimum requirements given below. These are necessary to reduce to a practical minimum the impact on the **GB Transmission System** of faults on circuits owned by **Generators** or **DC Converter Station** owners.

CC.6.2.2.2.2 Fault Clearance Times

- (a) The fault clearance times for faults on the **Generator's** or **DC Converter Station** owner's equipment directly connected to the **GB Transmission System** and for faults on the **GB Transmission System** directly connected to the **Generator** or **DC Converter Station** owner's equipment, from fault inception to the circuit breaker arc extinction, shall be set out in accordance with the **Bilateral Agreement**. The times specified in accordance with the **Bilateral Agreement** shall not be faster than:

- (i) 80mS at 400kV
- (ii) 100mS at 275kV
- (iii) 120mS at 132kV and below

but this shall not prevent a **User** or **NGET** having faster fault clearance times.

Slower fault clearance times may be specified in accordance with the **Bilateral Agreement** for faults on the **GB Transmission System**. Slower fault clearance times for faults on the **Generator** or **DC Converter Station** owner's equipment may be agreed in accordance with the terms of the **Bilateral Agreement** but only if **System** requirements, in **NGET's** view, permit. The probability that the fault clearance times stated in accordance with the **Bilateral Agreement** will be exceeded by any given fault, must be less than 2%.

- (b) For the event that the above fault clearance times are not met as a result of failure to operate on the **Main Protection System(s)** provided, the **Generators** or **DC Converter Station** owners shall provide **Back-Up Protection**. **NGET** will also provide **Back-Up Protection** and these **Back-Up Protections** will be co-ordinated so as to provide **Discrimination**.

On a **Generating Unit** (other than **Power Park Units**), **DC Converter** or **Power Park Module** connected to the **GB Transmission System** where only one **Main Protection** is provided to clear faults on the **HV Connections** within the required fault clearance time, the **Back-Up Protection** provided by the **Generators** and **DC Converter Station** owners shall operate to give a fault clearance time of no slower than 300 ms at the minimum infeed for normal operation for faults on the **HV Connections**. On **Generating Units** (other than **Power Park Units**), **DC Converters** or **Power Park Modules** connected to the **GB Transmission System** at 400 kV and 275 kV where two **Main Protections** are provided and on **Generating Units** (other than **Power Park Units**), **DC Converters** or **Power Park Modules** connected to the **GB Transmission System** at 132 kV and below, the **Back-Up Protection** shall operate to give a fault clearance time of no slower than 800 ms in England and Wales and 300 ms in Scotland at the minimum infeed for normal operation for faults on the **HV Connections**.

Generators' and **DC Converter Station** owners' **Back-Up Protection** will also be required to withstand, without tripping, the loading incurred during the clearance of a fault on the **GB Transmission System** by breaker fail **Protection** at 400kV or 275kV or of a fault cleared by **Back-Up Protection** where the **Generator** or **DC Converter** is connected at 132kV and below. This will permit **Discrimination** between **Generator** or **DC Converter Back-Up Protection** and **Back-Up Protection** provided on the **GB Transmission System** and other **Users' Systems**.

- (c) When the **Generating Unit** (other than **Power Park Units**), or the **DC Converter** or **Power Park Module** is connected to the **GB Transmission System** at 400kV or 275kV, and in Scotland also at 132kV, and a circuit breaker is provided by the **Generator** or the **DC Converter Station** owner, or **NGET**, as the case may be, to interrupt fault current interchange with the **GB Transmission System**, or **Generator's System**, or **DC Converter Station** owner's **System**, as the case may be, circuit breaker fail **Protection** shall be provided by the **Generator** or **DC Converter Station** owner, or **NGET**, as the case may be, on this circuit breaker. In the event, following operation of a **Protection** system, of a failure to interrupt fault current by these circuit-breakers within the **Fault Current Interruption Time**, the circuit breaker fail **Protection** is required to initiate tripping of all the necessary electrically adjacent circuit-breakers so as to interrupt the fault current within the next 200 ms.
- (d) The target performance for the **System Fault Dependability Index** shall be not less than 99%. This is a measure of the ability of **Protection** to initiate successful tripping of circuit breakers which are associated with the faulty item of **Apparatus**.

CC.6.2.2.3 Equipment to be provided

CC.6.2.2.3.1 Protection of Interconnecting Connections

The requirements for the provision of **Protection** equipment for interconnecting connections will be specified in the **Bilateral Agreement**. In this **CC** the term "interconnecting connections" means the primary conductors from the current transformer accommodation on the circuit side of the circuit breaker to the **Connection Point**.

CC.6.2.2.3.2 Circuit-breaker fail Protection

The **Generator** or **DC Converter Station** owner will install circuit breaker fail **Protection** equipment in accordance with the requirements of the **Bilateral Agreement**. The **Generator** or **DC Converter Station** owner will also provide a back-trip signal in the event of loss of air from its pressurised head circuit breakers, during the **Generating Unit** (other than a **CCGT Unit** or **Power Park Unit**) or **CCGT Module** or **DC Converter** or **Power Park Module** run-up sequence, where these circuit breakers are installed.

CC.6.2.2.3.3 Loss of Excitation

The **Generator** must provide **Protection** to detect loss of excitation on a **Generating Unit** and initiate a **Generating Unit** trip.

CC.6.2.2.3.4 Pole-Slipping Protection

Where, in **NGET's** reasonable opinion, **System** requirements dictate, **NGET** will specify in the **Bilateral Agreement** a requirement for **Generators** to fit pole-slipping **Protection** on their **Generating Units**.

CC.6.2.2.3.5 Signals for Tariff Metering

Generators and **DC Converter Station** owners will install current and voltage transformers supplying all tariff meters at a voltage to be specified in, and in accordance with, the **Bilateral Agreement**.

CC.6.2.2.4 Work on Protection Equipment

No busbar **Protection**, mesh corner **Protection**, circuit-breaker fail **Protection** relays, AC or DC wiring (other than power supplies or DC tripping associated with the **Generating Unit**, **DC Converter** or **Power Park Module** itself) may be worked upon or altered by the **Generator** or **DC Converter Station** owner personnel in the absence of a representative of **NGET** or in Scotland, a representative of **NGET**, or written authority from **NGET** to perform such work or alterations in the absence of a representative of **NGET**.

CC.6.2.2.5 Relay Settings

Protection and relay settings will be co-ordinated (both on connection and subsequently) across the **Connection Point** in accordance with the **Bilateral Agreement** to ensure effective disconnection of faulty **Apparatus**.

CC.6.2.3 Requirements at Connection Points relating to Network Operators and Non-Embedded Customers

CC.6.2.3.1 Protection Arrangements for Network Operators and Non-Embedded Customers

CC.6.2.3.1.1 **Protection of Network Operator and Non-Embedded Customers User Systems** directly supplied from the **GB Transmission System**, must meet the minimum requirements referred to below:

Fault Clearance Times

- (a) The fault clearance times for faults on **Network Operator** and **Non-Embedded Customer** equipment directly connected to the **GB Transmission System**, and for faults on the **GB Transmission System** directly connected to the **Network Operator's** or **Non-Embedded Customer's** equipment, from fault inception to the circuit breaker arc extinction, shall be set out in accordance with each **Bilateral Agreement**. The times specified in accordance with the **Bilateral Agreement** shall not be faster than:
- (i) 80mS at 400kV
 - (ii) 100mS at 275kV
 - (iii) 120mS at 132kV and below

but this shall not prevent a **User** or **NGET** having a faster fault clearance time.

Slower fault clearance times may be specified in accordance with the **Bilateral Agreement** for faults on the **GB Transmission System**. Slower fault clearance times for faults on the **Network Operator** and **Non-Embedded Customers** equipment may be agreed in accordance with the terms of the **Bilateral Agreement** but only if **System** requirements in **NGET's** view permit. The probability that the fault clearance times stated in accordance with the **Bilateral Agreement** will be exceeded by any given fault must be less than 2%.

- (b)
- (i) For the event of failure of the **Protection** systems provided to meet the above fault clearance time requirements, **Back-Up Protection** shall be provided by the **Network Operator** or **Non-Embedded Customer** as the case may be.
 - (ii) **NGET** will also provide **Back-Up Protection**, which will result in a fault clearance time slower than that specified for the **Network Operator** or **Non-Embedded Customer Back-Up Protection** so as to provide **Discrimination**.
 - (iii) For connections with the **GB Transmission System** at 132kV and below, it is normally required that the **Back-Up Protection** on the **GB Transmission System** shall discriminate with the **Network Operator** or **Non-Embedded Customer's Back-Up Protection**.
 - (iv) For connections with the **GB Transmission System** at 400kV or 275kV, the **Back-Up Protection** will be provided by the **Network Operator** or **Non-Embedded Customer**, as the case may be, with a fault clearance time not slower than 300mS for faults on the **Network Operator's** or **Non-Embedded Customer's Apparatus**.
 - (v) Such **Protection** will also be required to withstand, without tripping, the loading incurred during the clearance of a fault on the **GB Transmission System** by breaker fail **Protection** at 400kV or 275kV. This will permit **Discrimination** between **Network Operator** or **Non-Embedded Customer**, as the case may be, **Back-Up Protection** and **Back-Up Protection** provided on the **GB Transmission System** and other **User Systems**. The requirement for and level of **Discrimination** required will be specified in the **Bilateral Agreement**.
- (c)
- (i) Where the **Network Operator** or **Non-Embedded Customer** is connected to the **GB Transmission System** at 400kV or 275kV, and in

Scotland also at 132kV, and a circuit breaker is provided by the **Network Operator** or **Non-Embedded Customer**, or **NGET**, as the case may be, to interrupt the interchange of fault current with the **GB Transmission System** or the **System** of the **Network Operator** or **Non-Embedded Customer**, as the case may be, circuit breaker fail **Protection** will be provided by the **Network Operator** or **Non-Embedded Customer**, or **NGET**, as the case may be, on this circuit breaker.

(ii) In the event, following operation of a **Protection** system, of a failure to interrupt fault current by these circuit-breakers within the **Fault Current Interruption Time**, the circuit breaker fail **Protection** is required to initiate tripping of all the necessary electrically adjacent circuit-breakers so as to interrupt the fault current within the next 200 ms.

(d) The target performance for the **System Fault Dependability Index** shall be not less than 99%. This is a measure of the ability of **Protection** to initiate successful tripping of circuit breakers which are associated with the faulty items of **Apparatus**.

CC.6.2.3.2 Fault Disconnection Facilities

(a) Where no **Transmission** circuit breaker is provided at the **User's** connection voltage, the **User** must provide **NGET** with the means of tripping all the **User's** circuit breakers necessary to isolate faults or **System** abnormalities on the **GB Transmission System**. In these circumstances, for faults on the **User's System**, the **User's Protection** should also trip higher voltage **Transmission** circuit breakers. These tripping facilities shall be in accordance with the requirements specified in the **Bilateral Agreement**.

(b) **NGET** may require the installation of a **System to Generator Operational Intertripping Scheme** in order to enable the timely restoration of circuits following power **System** fault(s). These requirements shall be set out in the relevant **Bilateral Agreement**.

CC.6.2.3.3 Automatic Switching Equipment

Where automatic reclosure of **Transmission** circuit breakers is required following faults on the **User's System**, automatic switching equipment shall be provided in accordance with the requirements specified in the **Bilateral Agreement**.

CC.6.2.3.4 Relay Settings

Protection and relay settings will be co-ordinated (both on connection and subsequently) across the **Connection Point** in accordance with the **Bilateral Agreement** to ensure effective disconnection of faulty **Apparatus**.

CC.6.2.3.5 Work on Protection equipment

Where a **Transmission Licensee** owns the busbar at the **Connection Point**, no busbar **Protection**, mesh corner **Protection** relays, AC or DC wiring (other than power supplies or DC tripping associated with the **Network Operator** or **Non-Embedded Customer's Apparatus** itself) may be worked upon or altered by the **Network Operator** or **Non-Embedded Customer** personnel in the absence of a representative of **NGET** or in Scotland, a representative of **NGET**, or written authority from **NGET** to perform such work or alterations in the absence of a representative of **NGET**.

CC.6.2.3.6 Equipment to be provided

CC.6.2.3.6.1 Protection of Interconnecting Connections

The requirements for the provision of **Protection** equipment for interconnecting connections will be specified in the **Bilateral Agreement**.

CC.6.3 GENERAL GENERATING UNIT REQUIREMENTS

CC.6.3.1 This section sets out the technical and design criteria and performance requirements for **Generating Units, DC Converters and Power Park Modules** (whether directly connected to the **GB Transmission System** or **Embedded**) which each **Generator** or **DC Converter Station** owner must ensure are complied with in relation to its **Generating Units, DC Converters and Power Park Modules** but does not apply to **Small Power Stations** or individually to **Power Park Units**. References to **Generating Units, DC Converters and Power Park Modules** in this CC.6.3 should be read accordingly.

Plant Performance Requirements

- CC.6.3.2
- (a) All **Synchronous Generating Units** must be capable of supplying **Rated MW** at any point between the limits 0.85 **Power Factor** lagging and 0.95 **Power Factor** leading at the **Synchronous Generating Unit** terminals. The short circuit ratio of **Synchronous Generating Units** shall be not less than 0.5.
 - (b) Subject to paragraph (c) below, all **Non-Synchronous Generating Units, DC Converters and Power Park Modules** must be capable of maintaining zero transfer of **Reactive Power** at the **Grid Entry Point** (or **User System Entry Point** if **Embedded**) at all **Active Power** output levels under steady state voltage conditions. The steady state tolerance on **Reactive Power** transfer to and from the **GB Transmission System** expressed in MVar shall be no greater than 5% of the **Rated MW**.
 - (c) Subject to the provisions of CC.6.3.2(d) below, all **Non-Synchronous Generating Units, DC Converters** (excluding current source technology) and **Power Park Modules** (excluding those connected to the **Total System** by a current source **DC Converter**) with a **Completion Date** on or after 1 January 2006 must be capable of supplying **Rated MW** output at any point between the limits 0.95 **Power Factor** lagging and 0.95 **Power Factor** leading at the **Grid Entry Point** in England and Wales or at the HV side of the 33/132kV or 33/275kV or 33/400kV transformer for **Generators** directly connected to the **GB Transmission System** in Scotland (or **User System Entry Point** if **Embedded**). With all **Plant** in service, the **Reactive Power** limits defined at **Rated MW** at Lagging **Power Factor** will apply at all **Active Power** output levels above 20% of the **Rated MW** output as defined in Figure 1. With all **Plant** in service, the **Reactive Power** limits defined at **Rated MW** at Leading **Power Factor** will apply at all **Active Power** output levels above 50% of the **Rated MW** output as defined in Figure 1. With all **Plant** in service, the **Reactive Power** limits will reduce linearly below 50% **Active Power** output as shown in Figure 1 unless the requirement to maintain the **Reactive Power** limits defined at **Rated MW** at Leading **Power Factor** down to 20% **Active Power** output is specified in the **Bilateral Agreement**. These **Reactive Power** limits will be reduced pro rata to the amount of **Plant** in service.

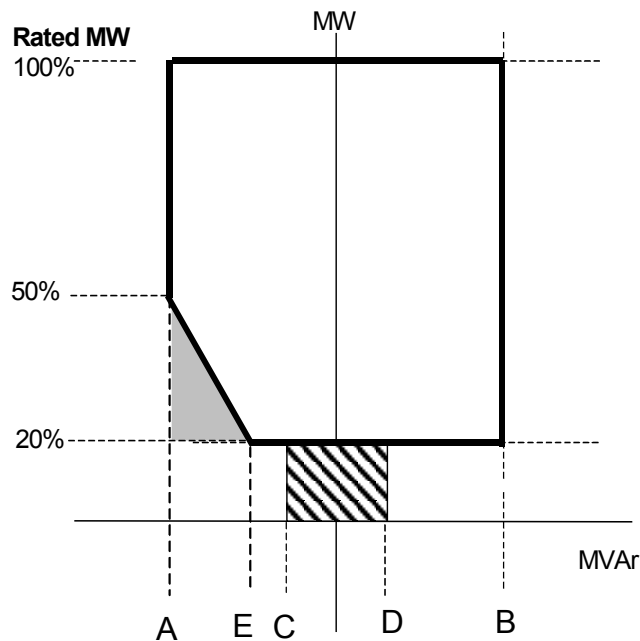

- Point A is equivalent (in MVar) to: 0.95 leading **Power Factor** at **Rated MW** output
- Point B is equivalent (in MVar) to: 0.95 lagging **Power Factor** at **Rated MW** output
- Point C is equivalent (in MVar) to: -5% of **Rated MW** output
- Point D is equivalent (in MVar) to: +5% of **Rated MW** output
- Point E is equivalent (in MVar) to: -12% of **Rated MW** output

Figure 1

- (d) All **Non-Synchronous Generating Units** and **Power Park Modules** in Scotland with a **Completion Date** after 1 April 2005 and before 1 January 2006 must be capable of supplying **Rated MW** at the range of power factors either:-
- (i) from 0.95 lead to 0.95 lag as illustrated in Figure 1 at the **User System Entry Point** for **Embedded Generators** or at the HV side of the 33/132kV or 33/275kV or 33/400kV transformer for **Generators** directly connected to the **GB Transmission System**. With all **Plant** in service, the **Reactive Power** limits defined at **Rated MW** will apply at all **Active Power** output levels above 20% of the **Rated MW** output as defined in Figure 1. These **Reactive Power** limits will be reduced pro rata to the amount of **Plant** in service.
- or,
- (ii) from 0.95 lead to 0.90 lag at the **Non-Synchronous Generating Unit** (including **Power Park Unit**) terminals. For the avoidance of doubt **Generators** complying with this option (ii) are not required to comply with CC.6.3.2(b).

CC.6.3.3 Each **Generating Unit, DC Converter, Power Park Module** and/or **CCGT Module** must be capable of

- (a) continuously maintaining constant **Active Power** output for **System Frequency** changes within the range 50.5 to 49.5 Hz; and

- (b) (subject to the provisions of CC.6.1.3) maintaining its **Active Power** output at a level not lower than the figure determined by the linear relationship shown in Figure 2 for **System Frequency** changes within the range 49.5 to 47 Hz, such that if the **System Frequency** drops to 47 Hz the **Active Power** output does not decrease by more than 5%.

In the case of a **CCGT Module**, the above requirement shall be retained down to the **Low Frequency Relay** trip setting of 48.8 Hz, which reflects the first stage of the Automatic Low **Frequency Demand Disconnection** scheme notified to **Network Operators** under OC6.6.2. For **System Frequency** below that setting, the existing requirement shall be retained for a minimum period of 5 minutes while **System Frequency** remains below that setting, and special measure(s) that may be required to meet this requirement shall be kept in service during this period. After that 5 minutes period, if **System Frequency** remains below that setting, the special measure(s) must be discontinued if there is a materially increased risk of the **Gas Turbine** tripping. The need for special measure(s) is linked to the inherent **Gas Turbine Active Power** output reduction caused by reduced shaft speed due to falling **System Frequency**

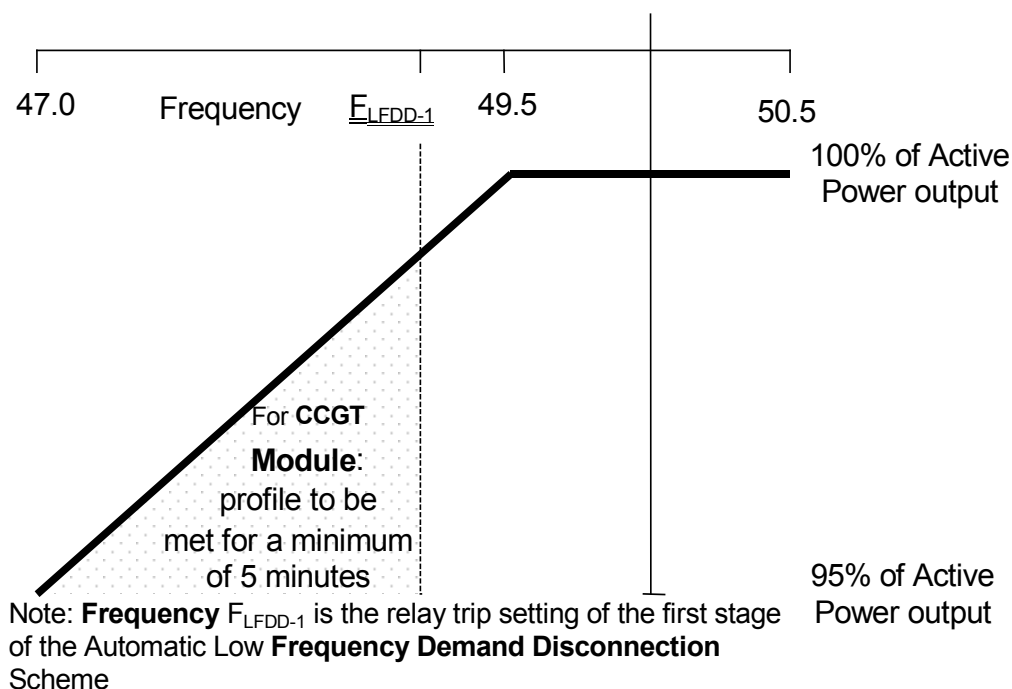

Figure 2

- (c) For the avoidance of doubt in the case of a **Generating Unit** or **Power Park Module** using an **Intermittent Power Source** where the mechanical power input will not be constant over time, the requirement is that the **Active Power** output shall be independent of **System Frequency** under (a) above and should not drop with **System Frequency** by greater than the amount specified in (b) above.
- (d) A **DC Converter Station** must be capable of maintaining its **Active Power** input (i.e. when operating in a mode analogous to **Demand**) from the **GB Transmission System** (or **User System** in the case of an **Embedded DC Converter Station**) at a level not greater than the figure determined by the linear relationship shown in Figure 3 for **System Frequency** changes within

the range 49.5 to 47 Hz, such that if the **System Frequency** drops to 47.8 Hz the **Active Power** input decreases by more than 60%.

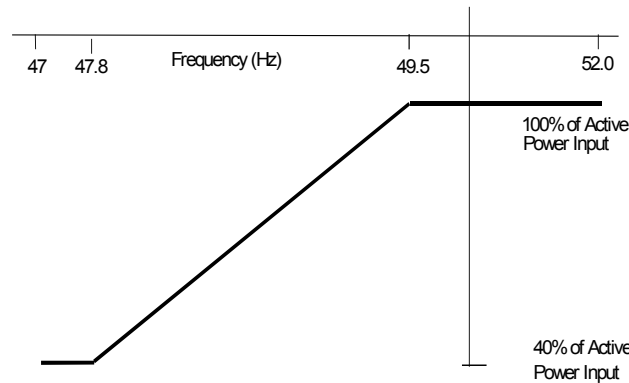

Figure 3

CC.6.3.4

At the **Grid Entry Point** the **Active Power** output under steady state conditions of any **Generating Unit, DC Converter or Power Park Module** directly connected to the **GB Transmission System** should not be affected by voltage changes in the normal operating range specified in paragraph CC.6.1.4 by more than the change in **Active Power** losses at reduced or increased voltage. The **Reactive Power** output under steady state conditions should be fully available within the voltage range $\pm 5\%$ at 400kV, 275kV and 132kV and lower voltages, except for a **Power Park Module** or **Non-synchronous Generating Unit** if **Embedded** at 33kV and below (or directly connected to the **GB Transmission System** in England and Wales at 33kV and below) where the requirement shown in Figure 4 applies.

Voltage at **Grid Entry Point** in England and Wales or **User System Entry Point** if **Embedded** (% of Nominal) at 33 kV and below

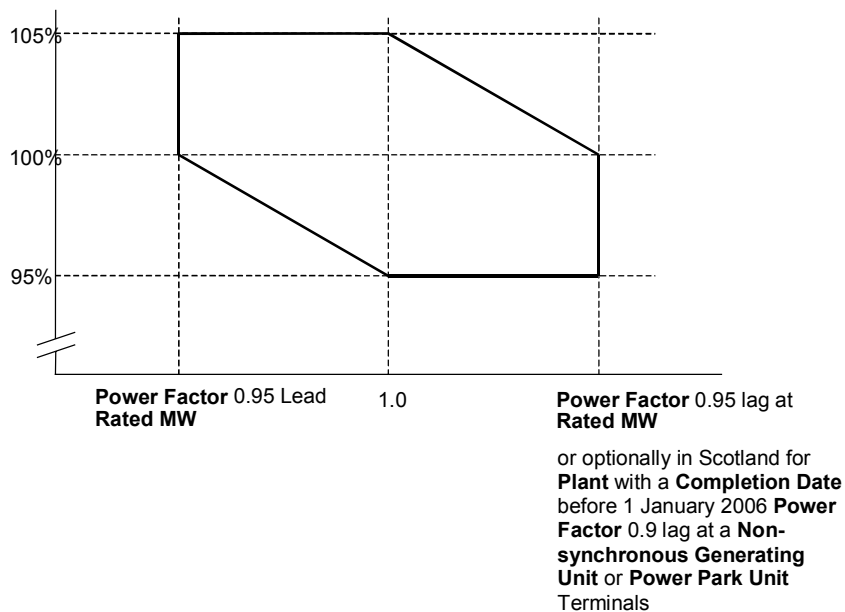

Figure 4

CC.6.3.5

It is an essential requirement that the **GB Transmission System** must incorporate a **Black Start Capability**. This will be achieved by agreeing a **Black Start Capability** at a number of strategically located **Power Stations**. For each **Power**

Station NGET will state in the **Bilateral Agreement** whether or not a **Black Start Capability** is required.

Control Arrangements

- CC.6.3.6 (a) Each:
- (i) **Generating Unit**; or,
 - (ii) **DC Converter** with a **Completion Date** on or after 1 April 2005; or,
 - (iii) **Power Park Module** in England and Wales with a **Completion Date** on or after 1 January 2006; or,
 - (iv) **Power Park Module** in operation in Scotland on or after 1 January 2006 (with a **Completion Date** after 1 July 2004 and in a **Power Station** with a **Registered Capacity** of 30MW or above),

must be capable of contributing to **Frequency** control by continuous modulation of **Active Power** supplied to the **GB Transmission System** or the **User System** in which it is **Embedded**.

- (b) Each:
- (i) **Generating Unit**; or,
 - (ii) **DC Converter** (with a **Completion Date** on or after 1 April 2005 excluding current source technologies); or
 - (iii) **Power Park Module** in England and Wales with a **Completion Date** on or after 1 January 2006; or,
 - (iv) **Power Park Module** in Scotland irrespective of **Completion Date**,

must be capable of contributing to voltage control by continuous changes to the **Reactive Power** supplied to the **GB Transmission System** or the **User System** in which it is **Embedded**.

- CC.6.3.7 (a) Each **Generating Unit**, **DC Converter** or **Power Park Module** (excluding **Power Park Modules** in Scotland with a **Completion Date** before 1 July 2004 or in a **Power Station** in Scotland with a **Registered Capacity** less than 30MW) must be fitted with a fast acting proportional **Frequency** control device (or turbine speed governor) and unit load controller or equivalent control device to provide **Frequency** response under normal operational conditions in accordance with **Balancing Code 3 (BC3)**. The **Frequency** control device (or speed governor) must be designed and operated to the appropriate:

- (i) **European Specification**; or
- (ii) in the absence of a relevant **European Specification**, such other standard which is in common use within the European Community (which may include a manufacturer specification);

as at the time when the installation of which it forms part was designed or (in the case of modification or alteration to the **Frequency** control device (or turbine speed governor)) when the modification or alteration was designed.

The **European Specification** or other standard utilised in accordance with sub-paragraph CC.6.3.7 (a) (ii) will be notified to **NGET** as:

- (i) part of the application for a **Bilateral Agreement**; or
 - (ii) part of the application for a varied **Bilateral Agreement**; or
 - (iii) soon as possible prior to any modification or alteration to the **Frequency** control device (or governor); and
- (b) The **Frequency** control device (or speed governor) in co-ordination with other control devices must control the **Generating Unit, DC Converter or Power Park Module Active Power Output** with stability over the entire operating range of the **Generating Unit, DC Converter or Power Park Module**; and
- (c) The **Frequency** control device (or speed governor) must meet the following minimum requirements:
- (i) Where a **Generating Unit, DC Converter or Power Park Module** becomes isolated from the rest of the **Total System** but is still supplying **Customers**, the **Frequency** control device (or speed governor) must also be able to control **System Frequency** below 52Hz unless this causes the **Generating Unit, DC Converter or Power Park Module** to operate below its **Designed Minimum Operating Level** when it is possible that it may, as detailed in BC 3.7.3, trip after a time. For the avoidance of doubt the **Generating Unit, DC Converter or Power Park Module** is only required to operate within the **System Frequency** range 47 - 52 Hz as defined in CC.6.1.3.;
 - (ii) the **Frequency** control device (or speed governor) must be capable of being set so that it operates with an overall speed **Droop** of between 3% and 5%;
 - (iii) in the case of all **Generating Units, DC Converter or Power Park Module** other than the **Steam Unit** within a **CCGT Module** the **Frequency** control device (or speed governor) deadband should be no greater than 0.03Hz (for the avoidance of doubt, $\pm 0.015\text{Hz}$). In the case of the **Steam Unit** within a **CCGT Module**, the speed governor deadband should be set to an appropriate value consistent with the requirements of CC.6.3.7(c)(i) and the requirements of BC3.7.2 for the provision of **Limited High Frequency Response**;

For the avoidance of doubt, the minimum requirements in (ii) and (iii) for the provision of **System Ancillary Services** do not restrict the negotiation of **Commercial Ancillary Services** between **NGET** and the **User** using other parameters; and

- (d) A facility to modify, so as to fulfil the requirements of the **Balancing Codes**, the **Target Frequency** setting either continuously or in a maximum of 0.05 Hz steps over at least the range 50 ± 0.1 Hz should be provided in the unit load controller or equivalent device.
- (e) (i) Each **Generating Unit** and/or **CCGT Module** which has a **Completion Date** after 1 January 2001 in England and Wales, and after 1 April 2005 in Scotland, must be capable of meeting the minimum **Frequency** response requirement profile subject to and in accordance with the provisions of Appendix 3.

- (ii) Each **DC Converter** at a **DC Converter Station** which has a **Completion Date** on or after 1 April 2005 must be capable of meeting the minimum **Frequency** response requirement profile subject to and in accordance with the provisions of Appendix 3.
 - (iii) Each **Power Park Module** in operation in England and Wales with a **Completion Date** on or after 1 January 2006 must be capable of meeting the minimum **Frequency** response requirement profile subject to and in accordance with the provisions of Appendix 3.
 - (iv) Each **Power Park Module** in operation on or after 1 January 2006 in Scotland (with a **Completion Date** on or after 1 April 2005 and a **Registered Capacity** of 30MW or greater) must be capable of meeting the minimum **Frequency** response requirement profile subject to and in accordance with the provisions of Appendix 3.
- (f) For the avoidance of doubt, the requirements of Appendix 3 do not apply to:
- (i) **Generating Units** and/or **CCGT Modules** which have a **Completion Date** before 1 January 2001 in England and Wales, and before 1 April 2005 in Scotland, for whom the remaining requirements of this clause CC.6.3.7 shall continue to apply unchanged: or
 - (ii) **DC Converters** at a **DC Converter Station** which have a **Completion Date** before 1 April 2005; or
 - (iii) **Power Park Modules** in England and Wales with a **Completion Date** before 1 January 2006 for whom only the requirements of **Limited Frequency Sensitive Mode** (BC.3.5.2) operation shall apply; or
 - (iv) **Power Park Modules** in operation in Scotland before 1 January 2006 for whom only the requirements of **Limited Frequency Sensitive Mode** (BC.3.5.2) operation shall apply; or
 - (v) **Power Park Modules** in operation after 1 January 2006 in Scotland which have a **Completion Date** before 1 April 2005 for whom the remaining requirements of this clause CC.6.3.7 shall continue to apply unchanged.

- CC.6.3.8
- (a) A continuously-acting automatic excitation control system is required to provide constant terminal voltage control of the **Synchronous Generating Unit** without instability over the entire operating range of the **Generating Unit**.
 - (b) The requirements for excitation control facilities, including **Power System Stabilisers**, where in **NGET's** view these are necessary for system reasons, will be specified in the **Bilateral Agreement**. Reference is made to on-load commissioning witnessed by **NGET** in BC2.11.2.
 - (c) In the case of a **Non-synchronous Generating Unit**, **DC Converter** or **Power Park Module** a continuously-acting automatic control system is required to provide control of the voltage (or zero transfer of **Reactive Power** as applicable to CC.6.3.2) at the **Grid Entry Point** or **User System**

Entry Point without instability over the entire operating range of the **Non-Synchronous Generating Unit, DC Converter or Power Park Module**. In the case of a **Power Park Module** in Scotland, voltage control may be at the **Power Park Unit** terminals, an appropriate intermediate busbar or the **Connection Point** as specified in the **Bilateral Agreement**. The automatic control system shall be designed to ensure a smooth transition between the shaded area bound by CD and the non shaded area bound by AB in Figure 1 of CC6.3.2 (c). The performance requirements for this automatic control system will be specified in the **Bilateral Agreement**.

- (d) In particular, other control facilities, including constant **Reactive Power** output control modes and constant **Power Factor** control modes (but excluding VAR limiters) are not required. However, if present in the excitation or voltage control system they will be disabled unless recorded in the **Bilateral Agreement**. Operation of such control facilities will be in accordance with the provisions contained in **BC2**.

Steady state Load Inaccuracies

- CC.6.3.9 The standard deviation of **Load** error at steady state **Load** over a 30 minute period must not exceed 2.5 per cent of a **Genset's Registered Capacity**. Where a **Genset** is instructed to **Frequency** sensitive operation, allowance will be made in determining whether there has been an error according to the governor droop characteristic registered under the **PC**.

For the avoidance of doubt in the case of a **Power Park Module** allowance will be made for the full variation of mechanical power output.

Negative Phase Sequence Loadings

- CC.6.3.10 In addition to meeting the conditions specified in CC.6.1.5(b), each **Synchronous Generating Unit** will be required to withstand, without tripping, the negative phase sequence loading incurred by clearance of a close-up phase-to-phase fault, by **System Back-Up Protection** on the **GB Transmission System** or **User System** in which it is **Embedded**.

Neutral Earthing

- CC.6.3.11 At nominal **System** voltages of 132kV and above the higher voltage windings of a transformer of a **Generating Unit, DC Converter or Power Park Module** must be star connected with the star point suitable for connection to earth. The earthing and lower voltage winding arrangement shall be such as to ensure that the **Earth Fault Factor** requirement of paragraph CC.6.2.1.1 (b) will be met on the **GB Transmission System** at nominal **System** voltages of 132kV and above.

Frequency Sensitive Relays

- CC.6.3.12 As stated in CC.6.1.3, the **System Frequency** could rise to 52Hz or fall to 47Hz. Each **Generating Unit, DC Converter, Power Park Module** or any constituent element must continue to operate within this **Frequency** range for at least the periods of time given in CC.6.1.3 unless **NGET** has agreed to any **Frequency**-level relays and/or rate-of-change-of-**Frequency** relays which will trip such **Generating Unit, DC Converter, Power Park Module** and any constituent element within this **Frequency** range, under the **Bilateral Agreement**.

CC.6.3.13 **Generators** and **DC Converter Station** owners will be responsible for protecting all their **Generating Units, DC Converters** or **Power Park Modules** against damage should **Frequency** excursions outside the range 52Hz to 47Hz ever occur. Should such excursions occur, it is up to the **Generator** or **DC Converter Station** owner to decide whether to disconnect his **Apparatus** for reasons of safety of **Apparatus, Plant** and/or personnel.

CC.6.3.14 It may be agreed in the **Bilateral Agreement** that a **Genset** shall have a **Fast-Start Capability**. Such **Gensets** may be used for **Operating Reserve** and their **Start-Up** may be initiated by **Frequency**-level relays with settings in the range 49Hz to 50Hz as specified pursuant to **OC2**.

CC.6.3.15 Fault Ride Through

- (a) Short circuit faults at **Supergrid Voltage** up to 140ms in duration
- (i) Each **Generating Unit, DC Converter, or Power Park Module** and any constituent **Power Park Unit** thereof shall remain transiently stable and connected to the **System** without tripping of any **Generating Unit, DC Converter** or **Power Park Module** and / or any constituent **Power Park Unit**, for a close-up solid three-phase short circuit fault or any unbalanced short circuit fault on the **GB Transmission System** operating at **Supergrid Voltages** for a total fault clearance time of up to 140 ms. A solid three-phase or unbalanced earthed fault results in zero voltage on the faulted phase(s) at the point of fault. The duration of zero voltage is dependent on local protection and circuit breaker operating times. This duration and the fault clearance times will be specified in the **Bilateral Agreement**. Following fault clearance, recovery of the **Supergrid Voltage** to 90% may take longer than 140ms as illustrated in Appendix 4 Figures CC.A.4.1 (a) and (b).
- (ii) Each **Generating Unit** or **Power Park Module** shall be designed such that upon both clearance of the fault on the **GB Transmission System** as detailed in CC.6.3.15 (a) (i) and within 0.5 seconds of the restoration of the **voltage at the Grid Entry Point** to the minimum levels specified in CC.6.1.4 (or within 0.5 seconds of restoration of the voltage at the **User System Entry Point** to 90% of nominal or greater if **Embedded**), **Active Power** output shall be restored to at least 90% of the level available immediately before the fault. During the period of the fault as detailed in CC.6.3.15 (a) (i) each **Generating Unit** or **Power Park Module** shall generate maximum reactive current without exceeding the transient rating limit of the **Generating Unit** or **Power Park Module** and / or any constituent **Power Park Unit**.
- (iii) Each **DC Converter** shall be designed to meet the **Active Power** recovery characteristics as specified in the **Bilateral Agreement** upon clearance of the fault on the **GB Transmission System** as detailed in CC.6.3.15 (a) (i).

- (b) **Supergrid Voltage** dips greater than 140ms in duration

In addition to the requirements of CC.6.3.15 (a) each **Generating Unit** or **Power Park Module** and / or any constituent **Power Park Unit**, each with a **Completion Date** on or after the 1 April 2005 shall:

- (i) remain transiently stable and connected to the **System** without tripping of any **Generating Unit** or **Power Park Module** and / or any constituent **Power Park**

Unit, for balanced **Supergrid Voltage** dips and associated durations anywhere on or above the heavy black line shown in Figure 5. Appendix 4 and Figures CC.A.4.3 (a), (b) and (c) provide an explanation and illustrations of Figure 5; and,

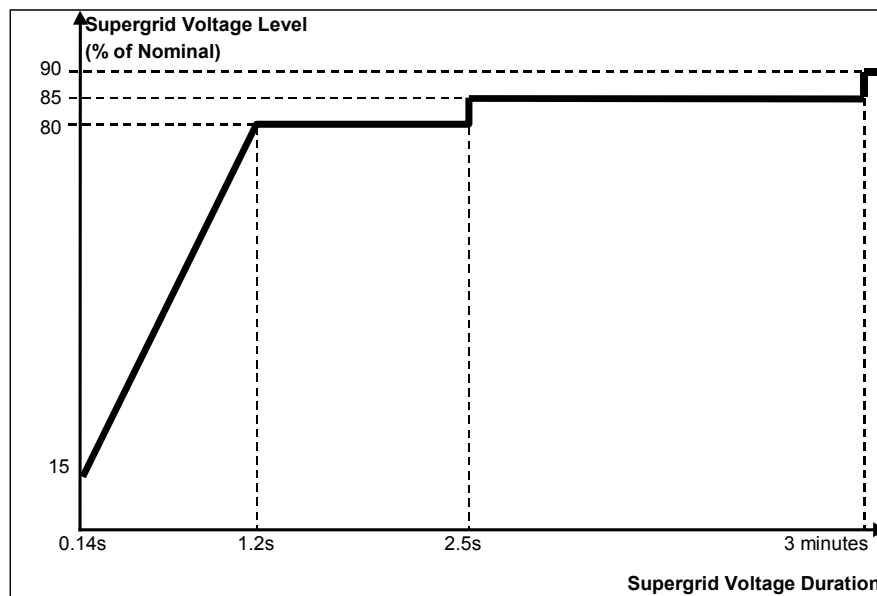

Figure 5

- (ii) provide **Active Power** output, during **Supergrid Voltage** dips as described in Figure 5, at least in proportion to the retained balanced voltage at the **Grid Entry Point** (or the retained balanced voltage at the **User System Entry Point** if **Embedded**) except in the case of a **Non-Synchronous Generating Unit** or **Power Park Module** where there has been a reduction in the **Intermittent Power Source** in the time range in Figure 5 that restricts the **Active Power** output below this level and shall generate maximum reactive current without exceeding the transient rating limits of the **Generating Unit** or **Power Park Module** and any constituent **Power Park Unit**; and,
- (iii) restore **Active Power** output, following **Supergrid Voltage** dips as described in Figure 5, within 1 second of restoration of the voltage at the **Grid Entry Point** to the minimum levels specified in CC.6.1.4 (or within 1 second of restoration of the voltage at the **User System Entry Point** to 90% of nominal or greater if **Embedded**), to at least 90% of the level available immediately before the occurrence of the dip except in the case of a **Non-Synchronous Generating Unit** or **Power Park Module** where there has been a reduction in the **Intermittent Power Source** in the time range in Figure 5 that restricts the **Active Power** output below this level.

For the avoidance of doubt a balanced **Supergrid Voltage** meets the requirements of CC.6.1.5 (b) and CC.6.1.6.

(c) Other Requirements

- (i) In the case of a **Power Park Module** (comprising of wind-turbine generator units), the requirements in CC.6.3.15(a) and CC.6.3.15(b) do not apply when the **Power Park Module** is operating at less than 5% of its **Rated MW** or during very high wind speed conditions when more than 50% of the wind turbine generator units in a **Power Park Module** have been shut down or disconnected under an emergency shutdown sequence to protect **User's Plant** and **Apparatus**.

- (ii) In addition to meeting the conditions specified in CC.6.1.5(b) and CC.6.1.6, each **Non-Synchronous Generating Unit** or **Power Park Module** and any constituent **Power Park Unit** thereof will be required to withstand, without tripping, the negative phase sequence loading incurred by clearance of a close-up phase-to-phase fault, by **System Back-Up Protection** on the **GB Transmission System** operating at **Supergrid Voltage**.
- (iii) In the case of a **Power Park Module** in Scotland with a **Completion Date** before 1 January 2004 and a **Registered Capacity** less than 30MW the requirements in CC.6.3.15 (a) do not apply. In the case of a **Power Park Module** in Scotland with a **Completion Date** on or after 1 January 2004 and before 1 July 2005 and a **Registered Capacity** less than 30MW the requirements in CC.6.3.15 (a) are relaxed from the minimum **Supergrid Voltage** of zero to a minimum **Supergrid Voltage** of 15% of nominal. In the case of a **Power Park Module** in Scotland with a **Completion Date** before 1 January 2004 and a **Registered Capacity** of 30MW and above the requirements in CC.6.3.15 (a) are relaxed from the minimum **Supergrid Voltage** of zero to a minimum **Supergrid Voltage** of 15% of nominal.
- (iv) To avoid unwanted island operation, **Non-Synchronous Generating Units** in Scotland or **Power Park Modules** in Scotland shall be tripped for the following conditions:-
 - (1) Frequency above 52Hz for more than 2 seconds
 - (2) Frequency below 47Hz for more than 2 seconds
 - (3) Voltage as measured at the **Connection Point** or **User System Entry Point** below 80% for more than 2 seconds
 - (4) Voltage as measured at the **Connection Point** or **User System Entry Point** above 120% (115% for 275kV) for more than 1 second.

The times in sections (1) and (2) are maximum trip times. Shorter times may be used to protect the **Non-Synchronous Generating Units** or **Power Park Modules**.

Additional Damping Control Facilities for DC Converters

- CC.6.3.16 (a) **DC Converter** owners must ensure that any of their **DC Converters** will not cause a sub-synchronous resonance problem on the **Total System**. Each **DC Converter** is required to be provided with sub-synchronous resonance damping control facilities.
- (b) Where specified in the **Bilateral Agreement**, each **DC Converter** is required to be provided with power oscillation damping or any other identified additional control facilities.

System to Generator Operational Intertripping Scheme

- CC.6.3.17 **NGET** may require that a **System to Generator Operational Intertripping Scheme** be installed as part of a condition of the connection of the **Generator**. Scheme specific details shall be included in the relevant **Bilateral Agreement**.

CC.6.4 GENERAL NETWORK OPERATOR AND NON-EMBEDDED CUSTOMER REQUIREMENTS

- CC.6.4.1 This part of the **Grid Code** describes the technical and design criteria and performance requirements for **Network Operators** and **Non-Embedded Customers**.

Neutral Earthing

- CC.6.4.2 At nominal **System** voltages of 132kV and above the higher voltage windings of three phase transformers and transformer banks connected to the **GB Transmission System** must be star connected with the star point suitable for connection to earth. The earthing and lower voltage winding arrangement shall be such as to ensure that the **Earth Fault Factor** requirement of paragraph CC.6.2.1.1 (b) will be met on the **GB Transmission System** at nominal **System** voltages of 132kV and above.

Frequency Sensitive Relays

- CC.6.4.3 As explained under **OC6**, each **Network Operator**, will make arrangements that will facilitate automatic low **Frequency Disconnection of Demand** (based on **Annual ACS Conditions**). The **Bilateral Agreement** will specify the manner in which **Demand** subject to low **Frequency** disconnection will be split into discrete MW blocks with associated **Low Frequency Relay** settings. Technical requirements relating to **Low Frequency Relays** are listed in Appendix 5.

CC.6.5 COMMUNICATIONS PLANT

- CC.6.5.1 In order to ensure control of the **GB Transmission System**, telecommunications between **Users** and **NGET** must, if required by **NGET**, be established in accordance with the requirements set down below.

Control Telephony

- CC.6.5.2 **Control Telephony** is the method by which a **User's Responsible Engineer/Operator** and **NGET Control Engineers** speak to one another for the purposes of control of the **Total System** in both normal and emergency operating conditions. **Control Telephony** provides secure point to point telephony for routine **Control Calls**, priority **Control Calls** and emergency **Control Calls**.

- CC.6.5.3 Supervisory tones indicate to the calling and receiving parties dial, engaged, ringing, secondary engaged (signifying that priority may be exercised) and priority disconnect tones.

- CC.6.5.4 Where **NGET** requires **Control Telephony**, **Users** are required to use the **Control Telephony** with **NGET** in respect of all **Connection Points** with the **GB Transmission System** and in respect of all **Embedded Large Power Stations** and **Embedded DC Converter Stations**. **NGET** will install **Control Telephony** at the **User's** location where the **User's** telephony equipment is not capable of providing the required facilities or is otherwise incompatible with the **Transmission Control Telephony**. Details of and relating to the **Control Telephony** required are contained in the **Bilateral Agreement**.

- CC.6.5.5 Detailed information on **Control Telephony** facilities and suitable equipment required for individual **User** applications will be provided by **NGET** upon request.

Operational Metering

- CC.6.5.6 (a) **NGET** shall provide system control and data acquisition (SCADA) outstation interface equipment. The **User** shall provide such voltage, current, **Frequency**, **Active Power** and **Reactive Power** measurement outputs and

plant status indications and alarms to the **Transmission** SCADA outstation interface equipment as required by **NGET** in accordance with the terms of the **Bilateral Agreement**.

- (b) For the avoidance of doubt, for **Active Power** and **Reactive Power** measurements, circuit breaker and disconnect status indications from:
- (i) **CCGT Modules** at **Large Power Stations**, the outputs and status indications must each be provided to **NGET** on an individual **CCGT Unit** basis. In addition, where identified in the **Bilateral Agreement**, **Active Power** and **Reactive Power** measurements from **Unit Transformers** and/or **Station Transformers** must be provided.
 - (ii) **DC Converters** at **DC Converter Stations**, the outputs and status indications must each be provided to **NGET** on an individual **DC Converter** basis. In addition, where identified in the **Bilateral Agreement**, **Active Power** and **Reactive Power** measurements from converter and/or station transformers must be provided.
 - (iii) **Power Park Modules** at **Embedded Large Power Stations** and at directly connected **Power Stations**, the outputs and status indications must each be provided to **NGET** on an individual **Power Park Module** basis. In addition, where identified in the **Bilateral Agreement**, **Active Power** and **Reactive Power** measurements from station transformers must be provided.
- (c) For the avoidance of doubt, the requirements of CC.6.5.6(a) in the case of a **Cascade Hydro Scheme** will be provided for each **Generating Unit** forming part of that **Cascade Hydro Scheme**. In the case of **Embedded Generating Units** forming part of a **Cascade Hydro Scheme** the data may be provided by means other than a **NGET** SCADA outstation located at the **Power Station**, such as, with the agreement of the **Network Operator** in whose system such **Embedded Generating Unit** is located, from the **Network Operator's** SCADA system to **NGET**. Details of such arrangements will be contained in the relevant **Bilateral Agreements** between **NGET** and the **Generator** and the **Network Operator**.
- (d) In the case of a **Power Park Module** an additional energy input signal (e.g. wind speed) may be specified in the **Bilateral Agreement**. The signal may be used to establish the level of energy input from the **Intermittent Power Source** for monitoring pursuant to CC.6.6.1 and **Ancillary Services** and will, in the case of a wind farm, be used to provide **NGET** with advanced warning of excess wind speed shutdown.

Instructor Facilities

- CC.6.5.7 The **User** shall accommodate **Instructor Facilities** provided by **NGET** for the receipt of operational messages relating to **System** conditions.

Electronic Data Communication Facilities

- CC.6.5.8 (a) All **BM Participants** must ensure that appropriate electronic data communication facilities are in place to permit the submission of data, as required by the **Grid Code**, to **NGET**.

- (b) In addition, any **User** that wishes to participate in the **Balancing Mechanism** must ensure that appropriate automatic logging devices are installed at the **Control Points** of its **BM Units** to submit data to and to receive instructions from **NGET**, as required by the **Grid Code**. For the avoidance of doubt, in the case of an **Interconnector User** the **Control Point** will be at the **Control Centre** of the appropriate **Externally Interconnected System Operator**.
- (c) Detailed specifications of these required electronic facilities will be provided by **NGET** on request and they are listed as **Electrical Standards** in the Annex to the **General Conditions**.

Facsimile Machines

CC.6.5.9 Each **User** and **NGET** shall provide a facsimile machine or machines:-

- (a) in the case of **Generators**, at the **Control Point** of each **Power Station** and at its **Trading Point**;
- (b) in the case of **NGET** and **Network Operators**, at the **Control Centre(s)**; and
- (c) in the case of **Non-Embedded Customers** and **DC Converter Station** owners at the **Control Point**.

Each **User** shall notify, prior to connection to the **System** of the **User's Plant and Apparatus**, **NGET** of its or their telephone number or numbers, and will notify **NGET** of any changes. Prior to connection to the **System** of the **User's Plant and Apparatus** **NGET** shall notify each **User** of the telephone number or numbers of its facsimile machine or machines and will notify any changes.

CC.6.5.10 Busbar Voltage

NGET shall, subject as provided below, provide each **Generator** or **DC Converter Station** owner at each **Grid Entry Point** where one of its **Power Stations** or **DC Converter Stations** is connected with appropriate voltage signals to enable the **Generator** or **DC Converter Station** owner to obtain the necessary information to permit its **Gensets** or **DC Converters** to be **Synchronised** to the **GB Transmission System**. The term "voltage signal" shall mean in this context, a point of connection on (or wire or wires from) a relevant part of **Transmission Plant** and/or **Apparatus** at the **Grid Entry Point**, to which the **Generator** or **DC Converter Station** owner, with **NGET's** agreement (not to be unreasonably withheld) in relation to the **Plant** and/or **Apparatus** to be attached, will be able to attach its **Plant** and/or **Apparatus** (normally a wire or wires) in order to obtain measurement outputs in relation to the busbar.

CC.6.5.11 Bilingual Message Facilities

- (a) A Bilingual Message Facility is the method by which the **User's Responsible Engineer/Operator**, the **Externally Interconnected System Operator** and **NGET Control Engineers** communicate clear and unambiguous information in two languages for the purposes of control of the **Total System** in both normal and emergency operating conditions.

- (b) A Bilingual Message Facility, where required, will provide up to two hundred pre-defined messages with up to five hundred and sixty characters each. A maximum of one minute is allowed for the transmission to, and display of, the selected message at any destination. The standard messages must be capable of being displayed at any combination of locations and can originate from any of these locations. Messages displayed in the UK will be displayed in the English language.
- (c) Detailed information on a Bilingual Message Facility and suitable equipment required for individual **User** applications will be provided by **NGET** upon request.

CC.6.6 SYSTEM MONITORING

CC.6.6.1 Monitoring equipment is provided on the **GB Transmission System** to enable **NGET** to monitor its power system dynamic performance conditions. Where this monitoring equipment requires voltage and current signals on the **Generating Unit** (other than **Power Park Unit**), **DC Converter** or **Power Park Module** circuit from the **User**, **NGET** will inform the **User** and they will be provided by the **User** with both the timing of the installation of the equipment for receiving such signals and its exact position being agreed (the **User's** agreement not to be unreasonably withheld) and the costs being dealt with, pursuant to the terms of the **Bilateral Agreement**.

CC.7 SITE RELATED CONDITIONS

CC.7.1 Not used.

CC.7.2 RESPONSIBILITIES FOR SAFETY

CC.7.2.1 In England and Wales, any **User** entering and working on its **Plant** and/or **Apparatus** on a **Transmission Site** will work to the **Safety Rules** of **NGET**.

In Scotland, any **User** entering and working on its **Plant** and/or **Apparatus** on a **Transmission Site** will work to the **Safety Rules** of the **Relevant Transmission Licensee**, as advised by **NGET**.

CC.7.2.2 **NGET** entering and working on **Transmission Plant** and/or **Apparatus** on a **User Site** will work to the **User's Safety Rules**. For **User Sites** in Scotland, **NGET** shall procure that the **Relevant Transmission Licensee** entering and working on **Transmission Plant** and/or **Apparatus** on a **User Site** will work to the **User's Safety Rules**.

CC.7.2.3 A **User** may, with a minimum of six weeks notice, apply to **NGET** for permission to work according to that **Users** own **Safety Rules** when working on its **Plant** and/or **Apparatus** on a **Transmission Site** rather than those set out in CC.7.2.1. If **NGET** is of the opinion that the **User's Safety Rules** provide for a level of safety commensurate with those set out in CC.7.2.1, **NGET** will notify the **User**, in writing, that, with effect from the date requested by the **User**, the **User** may use its own **Safety Rules** when working on its **Plant** and/or **Apparatus** on the **Transmission Site**. For a **Transmission Site** in Scotland, in forming its opinion, **NGET** will seek the opinion of the **Relevant Transmission Licensee**. Until receipt of such written approval from **NGET**, the **User** will continue to use the **Safety Rules** as set out in CC7.2.1.

CC.7.2.4 In the case of a **User Site** in England and Wales, **NGET** may, with a minimum of six weeks notice, apply to a **User** for permission to work according to **NGET's Safety Rules** when working on **Transmission Plant** and/or **Apparatus** on that **User Site**, rather than the **User's Safety Rules**. If the **User** is of the opinion that **NGET's Safety Rules** provide for a level of safety commensurate with that of that **User's Safety Rules**, it will notify **NGET**, in writing, that, with the effect from the date requested by **NGET**, **NGET** may use its own **Safety Rules** when working on its **Transmission Plant** and/or **Apparatus** on that **User Site**. Until receipt of such written approval from the **User**, **NGET** shall continue to use the **User's Safety Rules**.

In the case of a **User Site** in Scotland, **NGET** may, with a minimum of six weeks notice, apply to a **User** for permission for the **Relevant Transmission Licensee** to work according to the **Relevant Transmission Licensee's Safety Rules** when working on **Transmission Plant** and/or **Apparatus** on that **User Site**, rather than the **User's Safety Rules**. If the **User** is of the opinion that the **Relevant Transmission Licensee's Safety Rules**, provide for a level of safety commensurate with that of that **User's Safety Rules**, it will notify **NGET**, in writing, that, with effect from the date requested by **NGET**, that the **Relevant Transmission Licensee** may use its own **Safety Rules** when working on its **Transmission Plant** and/or **Apparatus** on that **User's Site**. Until receipt of such written approval from the **User**, **NGET** shall procure that the **Relevant Transmission Licensee** shall continue to use the **User's Safety Rules**.

CC.7.2.5 For a **Transmission Site** in England and Wales, if **NGET** gives its approval for the **User's Safety Rules** to apply to the **User** when working on its **Plant** and/or **Apparatus**, that does not imply that the **User's Safety Rules** will apply to entering the **Transmission Site** and access to the **User's Plant** and/or **Apparatus** on that **Transmission Site**. Bearing in mind **NGET's** responsibility for the whole **Transmission Site**, entry and access will always be in accordance with **NGET's** site access procedures. For a **User Site** in England and Wales, if the **User** gives its approval for **NGET's Safety Rules** to apply to **NGET** when working on its **Plant** and **Apparatus**, that does not imply that **NGET's Safety Rules** will apply to entering the **User Site**, and access to the **Transmission Plant** and **Apparatus** on that **User Site**. Bearing in mind the **User's** responsibility for the whole **User Site**, entry and access will always be in accordance with the **User's** site access procedures.

For a **Transmission Site** in Scotland, if **NGET** gives its approval for the **User's Safety Rules** to apply to the **User** when working on its **Plant** and/or **Apparatus**, that does not imply that the **User's Safety Rules** will apply to entering the **Transmission Site** and access to the **User's Plant** and/or **Apparatus** on that **Transmission Site**. Bearing in mind the **Relevant Transmission Licensee's** responsibility for the whole **Transmission Site**, entry and access will always be in accordance with the **Relevant Transmission Licensee's** site access procedures. For a **User Site** in Scotland, if the **User** gives its approval for **Relevant Transmission Licensee Safety Rules** to apply to the **Relevant Transmission Licensee** when working on its **Plant** and **Apparatus**, that does not imply that the **Relevant Transmission Licensee's Safety Rules** will apply to entering the **User Site**, and access to the **Transmission Plant** and **Apparatus** on that **User Site**. Bearing in mind the **User's** responsibility for the whole **User Site**, entry and access will always be in accordance with the **User's** site access procedures

CC.7.2.6 For **User Sites** in England and Wales, **Users** shall notify **NGET** of any **Safety Rules** that apply to **NGET's** staff working on **User Sites**. For **Transmission Sites**

in England and Wales, **NGET** shall notify **Users** of any **Safety Rules** that apply to the **User's** staff working on the **Transmission Site**.

For **User Sites** in Scotland, **Users** shall notify **NGET** of any **Safety Rules** that apply to the **Relevant Transmission Licensee's** staff working on **User Sites**. For **Transmission Sites** in Scotland **NGET** shall procure that the **Relevant Transmission Licensee** shall notify **Users** of any **Safety Rules** that apply to the **User's** staff working on the **Transmission Site**.

CC.7.2.7 Each **Site Responsibility Schedule** must have recorded on it the **Safety Rules** which apply to each item of **Plant** and/or **Apparatus**.

CC.7.3 **SITE RESPONSIBILITY SCHEDULES**

CC.7.3.1 In order to inform site operational staff and **NGET Control Engineers** of agreed responsibilities for **Plant** and/or **Apparatus** at the operational interface, a **Site Responsibility Schedule** shall be produced for **Connection Sites** in England and Wales for **NGET** and **Users** with whom they interface, and for **Connection Sites** in Scotland for **NGET**, the **Relevant Transmission Licensee** and **Users** with whom they interface.

CC.7.3.2 The format, principles and basic procedure to be used in the preparation of **Site Responsibility Schedules** are set down in Appendix 1.

CC.7.4 **OPERATION AND GAS ZONE DIAGRAMS**

Operation Diagrams

CC.7.4.1 An **Operation Diagram** shall be prepared for each **Connection Site** at which a **Connection Point** exists using, where appropriate, the graphical symbols shown in Part 1A of Appendix 2. **Users** should also note that the provisions of **OC11** apply in certain circumstances.

CC.7.4.2 The **Operation Diagram** shall include all **HV Apparatus** and the connections to all external circuits and incorporate numbering, nomenclature and labelling, as set out in **OC11**. At those **Connection Sites** where gas-insulated metal enclosed switchgear and/or other gas-insulated **HV Apparatus** is installed, those items must be depicted within an area delineated by a chain dotted line which intersects gas-zone boundaries. The nomenclature used shall conform with that used on the relevant **Connection Site** and circuit. The **Operation Diagram** (and the list of technical details) is intended to provide an accurate record of the layout and circuit interconnections, ratings and numbering and nomenclature of **HV Apparatus** and related **Plant**.

CC.7.4.3 A non-exhaustive guide to the types of **HV Apparatus** to be shown in the **Operation Diagram** is shown in Part 2 of Appendix 2, together with certain basic principles to be followed unless equivalent principles are approved by **NGET**.

Gas Zone Diagrams

CC.7.4.4 A **Gas Zone Diagram** shall be prepared for each **Connection Site** at which a **Connection Point** exists where gas-insulated switchgear and/or other gas-insulated **HV Apparatus** is utilised. They shall use, where appropriate, the graphical symbols shown in Part 1B of Appendix 2.

- CC.7.4.5 The nomenclature used shall conform with that used in the relevant **Connection Site** and circuit.
- CC.7.4.6 The basic principles set out in Part 2 of Appendix 2 shall be followed in the preparation of **Gas Zone Diagrams** unless equivalent principles are approved by **NGET**.

Preparation of **Operation** and **Gas Zone Diagrams** for **Users' Sites**

- CC.7.4.7 In the case of a **User Site**, the **User** shall prepare and submit to **NGET**, an **Operation Diagram** for all **HV Apparatus** on the **User** side of the **Connection Point** and **NGET** shall provide the **User** with an **Operation Diagram** for all **HV Apparatus** on the **Transmission** side of the **Connection Point**, in accordance with the timing requirements of the **Bilateral Agreement** and/or **Construction Agreement** prior to the **Completion Date** under the **Bilateral Agreement** and/or **Construction Agreement**.
- CC.7.4.8 The **User** will then prepare, produce and distribute, using the information submitted on the **User's Operation Diagram** and **NGET Operation Diagram**, a composite **Operation Diagram** for the complete **Connection Site**, also in accordance with the timing requirements of the **Bilateral Agreement** and/or **Construction Agreement** .
- CC.7.4.9 The provisions of CC7.4.7 and CC.7.4.8 shall apply in relation to **Gas Zone Diagrams** where gas-insulated switchgear and/or other gas-insulated **HV Apparatus** is utilised.

Preparation of **Operation** and **Gas Zone Diagrams** for **Transmission Sites**

- CC.7.4.10 In the case of an **Transmission Site**, the **User** shall prepare and submit to **NGET** an **Operation Diagram** for all **HV Apparatus** on the **User** side of the **Connection Point**, in accordance with the timing requirements of the **Bilateral Agreement** and/or **Construction Agreement**.
- CC.7.4.11 **NGET** will then prepare, produce and distribute, using the information submitted on the **User's Operation Diagram**, a composite **Operation Diagram** for the complete **Connection Site**, also in accordance with the timing requirements of the **Bilateral Agreement** and/or **Construction Agreement** .
- CC.7.4.12 The provisions of CC7.4.10 and CC.7.4.11 shall apply in relation to **Gas Zone Diagrams** where gas-insulated switchgear and/or other gas-insulated **HV Apparatus** is utilised.

CC.7.4.13 **Changes to **Operation** and **Gas Zone Diagrams****

- CC.7.4.13.1 When **NGET** has decided that it wishes to install new **HV Apparatus** or it wishes to change the existing numbering or nomenclature of **Transmission HV Apparatus** at a **Transmission Site**, **NGET** will (unless it gives rise to a **Modification** under the **CUSC**, in which case the provisions of the **CUSC** as to the timing apply) one month prior to the installation or change, send to each such **User** a revised **Operation Diagram** of that **Transmission Site**, incorporating the new **Transmission HV Apparatus** to be installed and its numbering and nomenclature or the changes, as the case may be. **OC11** is also relevant to certain **Apparatus**.

CC.7.4.13.2 When a **User** has decided that it wishes to install new **HV Apparatus**, or it wishes to change the existing numbering or nomenclature of its **HV Apparatus** at its **User Site**, the **User** will (unless it gives rise to a **Modification** under the **CUSC**, in which case the provisions of the **CUSC** as to the timing apply) one month prior to the installation or change, send to **NGET** a revised **Operation Diagram** of that **User Site** incorporating the new **User HV Apparatus** to be installed and its numbering and nomenclature or the changes as the case may be. **OC11** is also relevant to certain **Apparatus**.

CC.7.4.13.3 The provisions of CC7.4.13.1 and CC.7.4.13.2 shall apply in relation to **Gas Zone Diagrams** where gas-insulated switchgear and/or other gas-insulated **HV Apparatus** is installed.

Validity

CC.7.4.14 (a) The composite **Operation Diagram** prepared by **NGET** or the **User**, as the case may be, will be the definitive **Operation Diagram** for all operational and planning activities associated with the **Connection Site**. If a dispute arises as to the accuracy of the composite **Operation Diagram**, a meeting shall be held at the **Connection Site**, as soon as reasonably practicable, between **NGET** and the **User**, to endeavour to resolve the matters in dispute.

(b) An equivalent rule shall apply for **Gas Zone Diagrams** where they exist for a **Connection Site**.

CC.7.5 **SITE COMMON DRAWINGS**

CC.7.5.1 **Site Common Drawings** will be prepared for each **Connection Site** and will include **Connection Site** layout drawings, electrical layout drawings, common **Protection/control** drawings and common services drawings.

Preparation of Site Common Drawings for a User Site

CC.7.5.2 In the case of a **User Site**, **NGET** shall prepare and submit to the **User**, **Site Common Drawings** for the **Transmission** side of the **Connection Point** in accordance with the timing requirements of the **Bilateral Agreement** and/or **Construction Agreement**.

CC.7.5.3 The **User** will then prepare, produce and distribute, using the information submitted on the **Transmission Site Common Drawings**, **Site Common Drawings** for the complete **Connection Site** in accordance with the timing requirements of the **Bilateral Agreement** and/or **Construction Agreement**.

Preparation of Site Common Drawings for a Transmission Site

CC.7.5.4 In the case of a **Transmission Site**, the **User** will prepare and submit to **NGET** **Site Common Drawings** for the **User** side of the **Connection Point** in accordance with the timing requirements of the **Bilateral Agreement** and/or **Construction Agreement**.

CC.7.5.5 **NGET** will then prepare, produce and distribute, using the information submitted in the **User's Site Common Drawings**, **Site Common Drawings** for the complete **Connection Site** in accordance with the timing requirements of the **Bilateral Agreement** and/or **Construction Agreement**.

CC.7.5.6 When a **User** becomes aware that it is necessary to change any aspect of the **Site Common Drawings** at a **Connection Site** it will:

- (a) if it is a **User Site**, as soon as reasonably practicable, prepare, produce and distribute revised **Site Common Drawings** for the complete **Connection Site**; and
- (b) if it is a **Transmission Site**, as soon as reasonably practicable, prepare and submit to **NGET** revised **Site Common Drawings** for the **User** side of the **Connection Point** and **NGET** will then, as soon as reasonably practicable, prepare, produce and distribute, using the information submitted in the **User's Site Common Drawings**, revised **Site Common Drawings** for the complete **Connection Site**.

In either case, if in the **User's** reasonable opinion the change can be dealt with by it notifying **NGET** in writing of the change and for each party to amend its copy of the **Site Common Drawings** (or where there is only one set, for the party holding that set to amend it), then it shall so notify and each party shall so amend. If the change gives rise to a **Modification** under the **CUSC**, the provisions of the **CUSC** as to timing will apply.

CC.7.5.7 When **NGET** becomes aware that it is necessary to change any aspect of the **Site Common Drawings** at a **Connection Site** it will:

- (a) if it is a **Transmission Site**, as soon as reasonably practicable, prepare, produce and distribute revised **Site Common Drawings** for the complete **Connection Site**; and
- (b) if it is a **User Site**, as soon as reasonably practicable, prepare and submit to the **User** revised **Site Common Drawings** for the **Transmission** side of the **Connection Point** and the **User** will then, as soon as reasonably practicable, prepare, produce and distribute, using the information submitted in the **Transmission Site Common Drawings**, revised **Site Common Drawings** for the complete **Connection Site**.

In either case, if in **NGET's** reasonable opinion the change can be dealt with by it notifying the **User** in writing of the change and for each party to amend its copy of the **Site Common Drawings** (or where there is only one set, for the party holding that set to amend it), then it shall so notify and each party shall so amend. If the change gives rise to a **Modification** under the **CUSC**, the provisions of the **CUSC** as to timing will apply.

Validity

CC.7.5.8 The **Site Common Drawings** for the complete **Connection Site** prepared by the **User** or **NGET**, as the case may be, will be the definitive **Site Common Drawings** for all operational and planning activities associated with the **Connection Site**. If a dispute arises as to the accuracy of the **Site Common Drawings**, a meeting shall be held at the **Site**, as soon as reasonably practicable, between **NGET** and the **User**, to endeavour to resolve the matters in dispute.

CC.7.6 ACCESS

- CC.7.6.1 The provisions relating to access to **Transmission Sites** by **Users**, and to **Users' Sites** by **Transmission Licensees**, are set out in each **Interface Agreement** with, for **Transmission Sites** in England and Wales, **NGET** and each **User**, and for **Transmission Sites** in Scotland, the **Relevant Transmission Licensee** and each **User**.
- CC.7.6.2 In addition to those provisions, where a **Transmission Site** in England and Wales contains exposed **HV** conductors, unaccompanied access will only be granted to individuals holding an **Authority for Access** issued by **NGET** and where a **Transmission Site** in Scotland contains exposed **HV** conductors, unaccompanied access will only be granted to individuals holding an **Authority for Access** issued by the **Relevant Transmission Licensee**.
- CC.7.6.3 The procedure for applying for an **Authority for Access** is contained in the **Interface Agreement**.
- CC.7.7 MAINTENANCE STANDARDS
- CC.7.7.1 It is a requirement that all **User's Plant** and **Apparatus** on **Transmission Sites** is maintained adequately for the purpose for which it is intended and to ensure that it does not pose a threat to the safety of any **Transmission Plant, Apparatus** or personnel on the **Transmission Site**. **NGET** will have the right to inspect the test results and maintenance records relating to such **Plant** and **Apparatus** at any time. In Scotland, it is the **User's** responsibility to ensure that all the **User's Plant** and **Apparatus**, including protection systems, are tested and maintained and remain rated for the duty required. An annual update of system fault levels is available as part of the **Seven Year Statement**.
- CC.7.7.2 It is a requirement that all **Transmission Plant** and **Apparatus** on **User's Sites** is maintained adequately for the purposes for which it is intended and to ensure that it does not pose a threat to the safety of any of the **User's Plant, Apparatus** or personnel on the **User Site**. **Users** will have the right to inspect the test results and maintenance records relating to such **Plant** and **Apparatus**, at any time.
- CC.7.8 SITE OPERATIONAL PROCEDURES
- CC.7.8.1 **NGET** and **Users** with an interface with **NGET**, must make available staff to take necessary **Safety Precautions** and carry out operational duties as may be required to enable work/testing to be carried out and for the operation of **Plant** and **Apparatus** connected to the **Total System**.
- CC.7.9 **Generators** and **DC Converter Station** owners shall provide a **Control Point** in respect of each **Power Station** directly connected to the **GB Transmission System** and **Embedded Large Power Station** or **DC Converter Station**. The **Control Point** shall be continuously manned (except for **Embedded Power Stations** containing **Power Park Modules** in the **SHETL Transmission Area** which have a **Registered Capacity** less than 30MW where the **Control Point** shall be manned between the hours of 0800 and 1800 each day) to receive and act upon instructions pursuant to OC7 and BC2 at all times that **Generating Units** or **Power Park Modules** at the **Power Station** are generating or available to generate or **DC Converters** at the **DC Converter Station** are importing or exporting or available to do so.

CC.8 **ANCILLARY SERVICES**

CC.8.1 **System Ancillary Services**

The **CC** contain requirements for the capability for certain **Ancillary Services**, which are needed for **System** reasons ("**System Ancillary Services**"). There follows a list of these **System Ancillary Services**, together with the paragraph number of the **CC** (or other part of the **Grid Code**) in which the minimum capability is required or referred to. The list is divided into two categories: Part 1 lists the **System Ancillary Services** which **Generators** are obliged to provide and **DC Converter Station** owners are obliged to have the capability to supply, and Part 2 lists the **System Ancillary Services** which **Generators** will provide only if agreement to provide them is reached with **NGET**:

Part 1

- (a) **Reactive Power** supplied (in accordance with CC.6.3.2) otherwise than by means of synchronous or static compensators (except in the case of a **Power Park Module** where synchronous or static compensators within the **Power Park Module** may be used to provide **Reactive Power**)
- (b) **Frequency** Control by means of **Frequency** sensitive generation - CC.6.3.7 and BC3.5.1

Part 2

- (c) **Frequency** Control by means of **Fast Start** - CC.6.3.14
- (d) **Black Start Capability** - CC.6.3.5
- (e) **System to Generator Operational Intertripping**

CC.8.2 **Commercial Ancillary Services**

Other **Ancillary Services** are also utilised by **NGET** in operating the **Total System** if these have been agreed to be provided by a **User** (or other person) under an **Ancillary Services Agreement** or under a **Bilateral Agreement**, with payment being dealt with under an **Ancillary Services Agreement** or in the case of **Externally Interconnected System Operators** or **Interconnector Users**, under any other agreement (and in the case of **Externally Interconnected System Operators** and **Interconnector Users** includes ancillary services equivalent to or similar to **System Ancillary Services**) ("**Commercial Ancillary Services**"). The capability for these **Commercial Ancillary Services** is set out in the relevant **Ancillary Services Agreement** or **Bilateral Agreement** (as the case may be).

CONNECTION CONDITIONS

APPENDIX 1

FORMAT, PRINCIPLES AND BASIC PROCEDURE TO BE USED IN THE PREPARATION OF **SITE RESPONSIBILITY SCHEDULES**

CC.A.1.1 PRINCIPLES

Types of Schedules

CC.A.1.1.1 At all **Complexes** the following **Site Responsibility Schedules** shall be drawn up using the relevant proforma attached or with such variations as may be agreed between **NGET** and **Users**, but in the absence of agreement the relevant proforma attached will be used:

- (a) Schedule of **HV Apparatus**
- (b) Schedule of **Plant, LV/MV Apparatus**, services and supplies;
- (c) Schedule of telecommunications and measurements **Apparatus**.

Other than at **Generating Unit, DC Converter, Power Park Module** and **Power Station** locations, the schedules referred to in (b) and (c) may be combined.

New Connection Sites

CC.A.1.1.2 In the case of a new **Connection Site** each **Site Responsibility Schedule** for a **Connection Site** shall be prepared by **NGET** in consultation with relevant **Users** at least 2 weeks prior to the **Completion Date** under the **Bilateral Agreement** and/or **Construction Agreement** for that **Connection Site** (which may form part of a **Complex**). Each **User** shall, in accordance with the timing requirements of the **Bilateral Agreement** and/or **Construction Agreement**, provide information to **NGET** to enable it to prepare the **Site Responsibility Schedule**.

Sub-division

CC.A.1.1.3 Each **Site Responsibility Schedule** will be subdivided to take account of any separate **Connection Sites** on that **Complex**.

Scope

CC.A.1.1.4 Each **Site Responsibility Schedule** shall detail for each item of **Plant** and **Apparatus**:-

- (a) **Plant/Apparatus** ownership;
- (b) Site Manager (Controller) (except in the case of **Plant/Apparatus** located in **SPT's Transmission Area**);
- (c) Safety issues comprising applicable **Safety Rules** and **Control Person** or other responsible person (**Safety Co-ordinator**), or such other person who is responsible for safety;

- (d) Operations issues comprising applicable **Operational Procedures** and control engineer;
- (e) Responsibility to undertake statutory inspections, fault investigation and maintenance.

Each **Connection Point** shall be precisely shown.

Detail

- CC.A.1.1.5 (a) In the case of **Site Responsibility Schedules** referred to in CC.A.1.1.1(b) and (c), with the exception of **Protection Apparatus** and **Intertrip Apparatus** operation, it will be sufficient to indicate the responsible **User** or **Transmission Licensee**, as the case may be.
- (b) In the case of the **Site Responsibility Schedule** referred to in CC.A.1.1.1(a) and for **Protection Apparatus** and **Intertrip Apparatus**, the responsible management unit must be shown in addition to the **User** or **Transmission Licensee**, as the case may be.
- CC.A.1.1.6 The **HV Apparatus Site Responsibility Schedule** for each **Connection Site** must include lines and cables emanating from or traversing¹ the **Connection Site**.

Issue Details

- CC.A.1.1.7 Every page of each **Site Responsibility Schedule** shall bear the date of issue and the issue number.

Accuracy Confirmation

- CC.A.1.1.8 When a **Site Responsibility Schedule** is prepared it shall be sent by **NGET** to the **Users** involved for confirmation of its accuracy.
- CC.A.1.1.9 The **Site Responsibility Schedule** shall then be signed on behalf of **NGET** by its **Responsible Manager** (see CC.A.1.1.16) and on behalf of each **User** involved by its **Responsible Manager** (see CC.A.1.1.16), by way of written confirmation of its accuracy. For **Connection Sites** in Scotland, the **Site Responsibility Schedule** will also be signed on behalf of the **Relevant Transmission Licensee** by its **Responsible Manager**.

Distribution and Availability

- CC.A.1.1.10 Once signed, two copies will be distributed by **NGET**, not less than two weeks prior to its implementation date, to each **User** which is a party on the **Site Responsibility Schedule**, accompanied by a note indicating the issue number and the date of implementation.
- CC.A.1.1.11 **NGET** and **Users** must make the **Site Responsibility Schedules** readily available to operational staff at the **Complex** and at the other relevant control points.

¹ Details of circuits traversing the **Connection Site** are only needed from the date which is the earlier of the date when the **Site Responsibility Schedule** is first updated and 15th October 2004. In Scotland, from a date to be agreed between **NGET** and the **Relevant Transmission Licensee**.

Alterations to Existing **Site Responsibility Schedules**

- CC.A 1.1.12 Without prejudice to the provisions of CC.A.1.1.15 which deals with urgent changes, when a **User** identified on a **Site Responsibility Schedule** becomes aware that an alteration is necessary, it must inform **NGET** immediately and in any event 8 weeks prior to any change taking effect (or as soon as possible after becoming aware of it, if less than 8 weeks remain when the **User** becomes aware of the change). This will cover the commissioning of new **Plant** and/or Apparatus at the **Connection Site**, whether requiring a revised **Bilateral Agreement** or not, de-commissioning of **Plant** and/or **Apparatus**, and other changes which affect the accuracy of the **Site Responsibility Schedule**.
- CC.A 1.1.13 Where **NGET** has been informed of a change by a **User**, or itself proposes a change, it will prepare a revised **Site Responsibility Schedule** by not less than six weeks prior to the change taking effect (subject to it having been informed or knowing of the change eight weeks prior to that time) and the procedure set out in CC.A.1.1.8 shall be followed with regard to the revised **Site Responsibility Schedule**.
- CC.A 1.1.14 The revised **Site Responsibility Schedule** shall then be signed in accordance with the procedure set out in CC.A.1.1.9 and distributed in accordance with the procedure set out in CC.A.1.1.10, accompanied by a note indicating where the alteration(s) has/have been made, the new issue number and the date of implementation.

Urgent Changes

- CC.A.1.1.15 When a **User** identified on a **Site Responsibility Schedule**, or **NGET**, as the case may be, becomes aware that an alteration to the **Site Responsibility Schedule** is necessary urgently to reflect, for example, an emergency situation which has arisen outside its control, the **User** shall notify **NGET**, or **NGET** shall notify the **User**, as the case may be, immediately and will discuss:
- (a) what change is necessary to the **Site Responsibility Schedule**;
 - (b) whether the **Site Responsibility Schedule** is to be modified temporarily or permanently;
 - (c) the distribution of the revised **Site Responsibility Schedule**.

NGET will prepare a revised **Site Responsibility Schedule** as soon as possible, and in any event within seven days of it being informed of or knowing the necessary alteration. The **Site Responsibility Schedule** will be confirmed by **Users** and signed on behalf of **NGET** and **Users** (by the persons referred to in CC.A.1.1.9) as soon as possible after it has been prepared and sent to **Users** for confirmation.

Responsible Managers

- CC.A.1.1.16 Each **User** shall, prior to the **Completion Date** under each **Bilateral Agreement** and/or **Construction Agreement**, supply to **NGET** a list of Managers who have been duly authorised to sign **Site Responsibility Schedules** on behalf of the **User** and **NGET** shall, prior to the **Completion Date** under each **Bilateral Agreement** and/or **Construction Agreement**, supply to that **User** the name of its **Responsible Manager** and for **Connection Sites** in Scotland, the name of the **Relevant Transmission Licensee's Responsible Manager** and each shall supply to the other any changes to such list six weeks before the change takes effect where the

change is anticipated, and as soon as possible after the change, where the change was not anticipated.

De-commissioning of **Connection Sites**

CC.A.1.1.17 Where a **Connection Site** is to be de-commissioned, whichever of **NGET** or the **User** who is initiating the de-commissioning must contact the other to arrange for the **Site Responsibility Schedule** to be amended at the relevant time.

ATTACHMENT TO APPENDIX 1 OF CONNECTION CONDITIONS

PROFORMA FOR SITE RESPONSIBILITY SCHEDULE

_____ AREA

COMPLEX: _____

SCHEDULE: _____

CONNECTION SITE: _____

ITEM OF PLANT/ APPARATUS	PLANT APPARATUS OWNER	SITE MANAGER	SAFETY		OPERATIONS		PARTY RESPONSIBLE FOR UNDERTAKING STATUTORY INSPECTIONS, FAULT INVESTIGATION & MAINTENANCE	REMARKS
			SAFETY RULES	CONTROL OR OTHER RESPONSIBLE PERSON (SAFETY CO-ORDINATOR)	OPERATIONAL PROCEDURES	CONTROL OR OTHER RESPONSIBLE ENGINEER		

PAGE: _____ ISSUE NO: _____ DATE: _____

ATTACHMENT TO APPENDIX 1 OF CONNECTION CONDITIONS

PROFORMA FOR SITE RESPONSIBILITY SCHEDULE

_____ AREA

COMPLEX: _____

SCHEDULE: _____

CONNECTION SITE: _____

ITEM OF PLANT/ APPARATUS	PLANT APPARATUS OWNER	SITE MANAGER	SAFETY		OPERATIONS		PARTY RESPONSIBLE FOR UNDERTAKING STATUTORY INSPECTIONS, FAULT INVESTIGATION & MAINTENANCE	REMARKS
			SAFETY RULES	CONTROL OR OTHER RESPONSIBLE PERSON (SAFETY CO-ORDINATOR)	OPERATIONAL PROCEDURES	CONTROL OR OTHER RESPONSIBLE ENGINEER		

NOTES:

SIGNED: _____ NAME: _____ COMPANY: _____ DATE: _____

SIGNED: _____ NAME: _____ COMPANY: _____ DATE: _____

SIGNED: _____ NAME: _____ COMPANY: _____ DATE: _____

SIGNED: _____ NAME: _____ COMPANY: _____ DATE: _____

PAGE: _____ ISSUE NO: _____ DATE: _____

**SP TRANSMISSION Ltd
SITE RESPONSIBILITY SCHEDULE
OWNERSHIP, MAINTENANCE AND OPERATIONS OF EQUIPMENT
IN JOINT USER SITUATIONS**

Sheet No. _____
Revision: _____
Date: _____

Network Area: _____

SECTION 'A' BUILDING AND SITE		SECTION 'B' CUSTOMER OR OTHER PARTY	
OWNER	ACCESS REQUIRED:-	NAME:-	
LESSEE	SPECIAL CONDITIONS:-	ADDRESS:-	
MAINTENANCE	LOCATION OF SUPPLY	TELNO:-	
SAFETY	TERMINALS:-	SUB STATION:-	
SECURITY		LOCATION:-	

ITEM Nos	EQUIPMENT	IDENTIFICATION	OWNER	SAFETY RULES APPLICABLE	OPERATION			MAINTENANCE		FAULT INVESTIGATION		TESTING		RELAY SETTINGS	REMARKS
					Tripping	Closing	Isolating	Earthing	Primary Equip	Protection Equip	Primary Equip	Protection Equip	Reclosure		

SECTION 'D' CONFIGURATION AND CONTROL		SECTION 'E' ADDITIONAL INFORMATION	
ITEM Nos	CONNECTION RESPONSIBILITY	TELEPHONE NUMBER	REMARKS
ITEM Nos	CONTROL RESPONSIBILITY	TELEPHONE NUMBER	REMARKS

ABBREVIATIONS:-
D - SP AUTHORISED PERSON - DISTRIBUTION SYSTEM
NGC - NATIONAL GRID COMPANY
SPD - SP DISTRIBUTION LTD
SPPS - POWERSYSTEMS
SPT - SP TRANSMISSION Ltd
ST - SCOTTISH POWER TELECOMMUNICATIONS
T - SP AUTHORISED PERSON - TRANSMISSION SYSTEM
U - USER

SIGNED _____ FOR _____ DATE _____
SIGNED _____ FOR _____ DATE _____
SIGNED _____ FOR _____ DATE _____

Scottish Hydro-Electric Transmission Limited

Site Responsibility Schedule

Substation Type					Number:				Revision:			
Equipment	Owner	Controller	Maintainer	Responsible System User	Responsible Management Unit	Control Authority	Safety Rules	Operational Procedures	Notes			

CONNECTION CONDITIONS

APPENDIX 2

PART 1A

PROCEDURES RELATING TO OPERATION DIAGRAMS

FIXED CAPACITOR		SWITCH DISCONNECTOR	
EARTH		SWITCH DISCONNECTOR WITH INCORPORATED EARTH SWITCH	
EARTHING RESISTOR		DISCONNECTOR (CENTRE ROTATING POST)	
LIQUID EARTHING RESISTOR		DISCONNECTOR (SINGLE BREAK DOUBLE ROTATING)	
ARC SUPPRESSION COIL		DISCONNECTOR (SINGLE BREAK)	
FIXED MAINTENANCE EARTHING DEVICE		DISCONNECTOR (NON-INTERLOCKED)	
CARRIER COUPLING EQUIPMENT (WITHOUT VT)		DISCONNECTOR (POWER OPERATED)	
CARRIER COUPLING EQUIPMENT (WITH VT ON ONE PHASE)		DISCONNECTOR (NON-AUTOMATIC)	
CARRIER COUPLING EQUIPMENT (WITH VT ON 3 PHASES)		DISCONNECTOR (AUTOMATIC)	
AC GENERATOR		DISCONNECTOR (SEQUENTIAL OPERATION)	
SYNCHRONOUS COMPENSATOR		DISCONNECTOR (FAULT INTERFERING OPERATION)	
CIRCUIT BREAKER		EARTH SWITCH	
CIRCUIT BREAKER WITH DELAYED AUTO RECLOSE		FAULT THROWING SWITCH (PHASE TO PHASE)	
WITHDRAWABLE METALCLAD SWITCHGEAR		FAULT THROWING SWITCH (EARTH FAULT)	
		SURGE ARRESTOR	
		THYRISTOR	

TRANSFORMERS
(VECTORS TO INDICATE
WINDING CONFIGURATION)

TWO WINDING



THREE WINDING

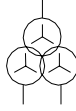

AUTO



AUTO WITH DELTA TERTIARY

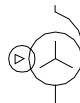

EARTHING OR AUX. TRANSFORMER

(-) INDICATE REMOTE SITE
IF APPLICABLE

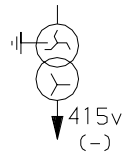

VOLTAGE TRANSFORMERS

SINGLE PHASE WOUND



THREE PHASE WOUND



SINGLE PHASE CAPACITOR



TWO SINGLE PHASE CAPACITOR



THREE PHASE CAPACITOR



* CURRENT TRANSFORMER
(WHERE SEPARATE PRIMARY
APPARATUS)



* COMBINED VT/CT UNIT
FOR METERING

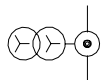

REACTOR



* BUSBARS



* OTHER PRIMARY CONNECTIONS



* CABLE & CABLE SEALING END

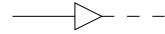

* THROUGH WALL BUSHING

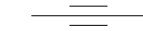

* BYPASS FACILITY



* CROSSING OF CONDUCTORS
(LOWER CONDUCTOR
TO BE BROKEN)

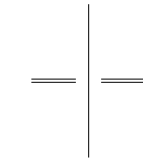

PREFERENTIAL ABBREVIATIONS

AUXILIARY TRANSFORMER	Aux T
EARTHING TRANSFORMER	ET
GAS TURBINE	Gas T
GENERATOR TRANSFORMER	Gen T
GRID TRANSFORMER	Gr T
SERIES REACTOR	Ser Reac
SHUNT REACTOR	Sh Reac
STATION TRANSFORMER	Stn T
SUPERGRID TRANSFORMER	SGT
UNIT TRANSFORMER	UT

* NON-STANDARD SYMBOL

PORTABLE MAINTENANCE
EARTH DEVICE



DISCONNECTOR
(PANTOGRAPH TYPE)



QUADRATURE BOOSTER

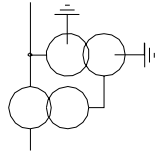

DISCONNECTOR
(KNEE TYPE)



SHORTING/DISCHARGE SWITCH

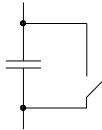

CAPACITOR
(INCLUDING HARMONIC FILTER)



SINGLE PHASE TRANSFORMER (BR)
NEUTRAL AND PHASE CONNECTIONS

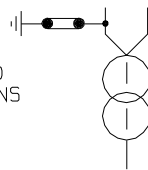

RESISTOR WITH INHERENT
NON-LINEAR VARIABILITY,
VOLTAGE DEPENDANT

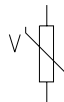

CONNECTION CONDITIONS

APPENDIX 2

PART 1B

PROCEDURES RELATING TO GAS ZONE DIAGRAMS

GAS INSULATED
BUSBAR

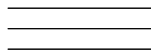

DOUBLE-BREAK
DISCONNECTOR

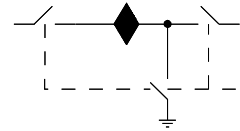

GAS BOUNDARY



EXTERNAL MOUNTED
CURRENT TRANSFORMER
(WHERE SEPARATE
PRIMARY APPARATUS)

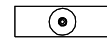

GAS/GAS BOUNDARY



STOP VALVE
NORMALLY CLOSED



GAS/CABLE BOUNDARY



STOP VALVE
NORMALLY OPEN



GAS/AIR BOUNDARY



GAS MONITOR



GAS/TRANSFORMER BOUNDARY



FILTER



MAINTENANCE VALVE

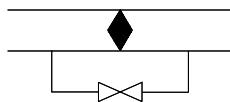

QUICK ACTING COUPLING



CONNECTION CONDITIONS

APPENDIX 2

NON-EXHAUSTIVE LIST OF APPARATUS TO BE INCLUDED ON OPERATION DIAGRAMS

PART 2

Basic Principles

1. Where practicable, all the **HV Apparatus** on any **Connection Site** shall be shown on one **Operation Diagram**. Provided the clarity of the diagram is not impaired, the layout shall represent as closely as possible the geographical arrangement on the **Connection Site**.
2. Where more than one **Operation Diagram** is unavoidable, duplication of identical information on more than one **Operation Diagram** must be avoided.
3. The **Operation Diagram** must show accurately the current status of the **Apparatus** eg. whether commissioned or decommissioned. Where decommissioned, the associated switchbay will be labelled "spare bay".
4. Provision will be made on the **Operation Diagram** for signifying approvals, together with provision for details of revisions and dates.
5. **Operation Diagrams** will be prepared in A4 format or such other format as may be agreed with **NGET**.
6. The **Operation Diagram** should normally be drawn single line. However, where appropriate, detail which applies to individual phases shall be shown. For example, some **HV Apparatus** is numbered individually per phase.

APPARATUS TO BE SHOWN ON OPERATION DIAGRAM

1. Busbars
2. Circuit Breakers
3. Disconnect (Isolator) and Switch Disconnecters (Switching Isolators)
4. Disconnectors (Isolators) - Automatic Facilities
5. Bypass Facilities
6. Earthing Switches
7. Maintenance Earths
8. Overhead Line Entries
9. Overhead Line Traps
10. Cable and Cable Sealing Ends
11. Generating Unit
12. Generator Transformers
13. Generating Unit Transformers, Station Transformers, including the lower voltage circuit-breakers.
14. Synchronous Compensators
15. Static Variable Compensators
16. Capacitors (including Harmonic Filters)
17. Series or Shunt Reactors (Referred to as "Inductors" at nuclear power station sites)
18. Supergrid and Grid Transformers
19. Tertiary Windings
20. Earthing and Auxiliary Transformers
21. Three Phase VT's
22. Single Phase VT & Phase Identity
23. High Accuracy VT and Phase Identity
24. Surge Arrestors/Diverters
25. Neutral Earthing Arrangements on HV Plant
26. Fault Throwing Devices
27. Quadrature Boosters
28. Arc Suppression Coils
29. Single Phase Transformers (BR) Neutral and Phase Connections
30. Current Transformers (where separate plant items)
31. Wall Bushings
32. Combined VT/CT Units
33. Shorting and Discharge Switches
34. Thyristor
35. Resistor with Inherent Non-Linear Variability, Voltage Dependent
36. Gas Zone

CONNECTION CONDITIONS

APPENDIX 3

MINIMUM FREQUENCY RESPONSE REQUIREMENT PROFILE AND OPERATING RANGE for new Power Stations and DC Converter Stations.

CC.A.3.1 SCOPE

The frequency response capability is defined in terms of **Primary Response**, **Secondary Response** and **High Frequency Response**. This appendix defines the minimum frequency response requirement profile for:

- (a) each **Generating Unit** and/or **CCGT Module** which has a **Completion Date** after 1 January 2001 in England and Wales and 1 April 2005 in Scotland,
- (b) each **DC Converter** at a **DC Converter Station** which has a **Completion Date** on or after 1 April 2005.
- (c) each **Power Park Module** in England and Wales with a **Completion Date** on or after 1 January 2006.
- (d) each **Power Park Module** in operation in Scotland after 1 January 2006 with a **Completion Date** after 1 April 2005 and in **Power Stations** with a **Registered Capacity** of 30MW or above.

For the avoidance of doubt, this appendix does not apply to:-

- (i) **Generating Units** and/or **CCGT Modules** which have a **Completion Date** before 1 January 2001 in England and Wales and before 1 April 2005 in Scotland,
- (ii) **DC Converters** at a **DC Converter Station** which have a **Completion Date** before 1 April 2005.
- (iii) **Power Park Modules** in England and Wales with a **Completion Date** before 1 January 2006.
- (iv) **Power Park Modules** in operation in Scotland before 1 January 2006.
- (v) **Power Park Modules** in Scotland with a **Completion Date** before 1 April 2005.
- (vi) **Power Park Modules** in Scotland in **Power Stations** with a **Registered Capacity** less than 30MW.
- (vii) **Small Power Stations** or individually to **Power Park Units**.

The functional definition provides appropriate performance criteria relating to the provision of **Frequency** control by means of **Frequency** sensitive generation in addition to the other requirements identified in CC.6.3.7.

In this Appendix 3 to the **CC**, for a **CCGT Module** or a **Power Park Module** with more than one **Generating Unit**, the phrase **Minimum Generation** applies to the entire **CCGT**

Module or Power Park Module operating with all Generating Units Synchronised to the System.

The minimum **Frequency** response requirement profile is shown diagrammatically in Figure CC.A.3.1. The capability profile specifies the minimum required levels of **Primary Response**, **Secondary Response** and **High Frequency Response** throughout the normal plant operating range. The definitions of these **Frequency** response capabilities are illustrated diagrammatically in Figures CC.A.3.2 & CC.A.3.3.

CC.A.3.2 PLANT OPERATING RANGE

The upper limit of the operating range is the **Registered Capacity** of the **Generating Unit** or **CCGT Module** or **DC Converter** or **Power Park Module**.

The **Minimum Generation** level may be less than, but must not be more than, 65% of the **Registered Capacity**. Each **Generating Unit** and/or **CCGT Module** and/or **Power Park Module** and/or **DC Converter** must be capable of operating satisfactorily down to the **Designed Minimum Operating Level** as dictated by **System** operating conditions, although it will not be instructed to below its **Minimum Generation** level. If a **Generating Unit** or **CCGT Module** or **Power Park Module** or **DC Converter** is operating below **Minimum Generation** because of high **System Frequency**, it should recover adequately to its **Minimum Generation** level as the **System Frequency** returns to **Target Frequency** so that it can provide **Primary** and **Secondary Response** from **Minimum Generation** if the **System Frequency** continues to fall. For the avoidance of doubt, under normal operating conditions steady state operation below **Minimum Generation** is not expected. The **Designed Minimum Operating Level** must not be more than 55% of **Registered Capacity**.

In the event of a **Generating Unit** or **CCGT Module** or **Power Park Module** or **DC Converter** load rejecting down to no less than its **Designed Minimum Operating Level** it should not trip as a result of automatic action as detailed in BC3.7. If the load rejection is to a level less than the **Designed Minimum Operating Level** then it is accepted that the condition might be so severe as to cause it to be disconnected from the **System**.

CC.A.3.3 MINIMUM FREQUENCY RESPONSE REQUIREMENT PROFILE

Figure CC.A.3.1 shows the minimum **Frequency** response requirement profile diagrammatically for a 0.5 Hz change in **Frequency**. The percentage response capabilities and loading levels are defined on the basis of the **Registered Capacity** of the **Generating Unit** or **CCGT Module** or **Power Park Module** or **DC Converter**. Each **Generating Unit** and/or **CCGT Module** and/or **Power Park Module** and/or **DC Converter** must be capable of operating in a manner to provide **Frequency** response at least to the solid boundaries shown in the figure. If the **Frequency** response capability falls within the solid boundaries, the **Generating Unit** or **CCGT Module** or **Power Park Module** or **DC Converter** is providing response below the minimum requirement which is not acceptable. Nothing in this appendix is intended to prevent a **Generating Unit** or **CCGT Module** or **Power Park Module** or **DC Converter** from being designed to deliver a **Frequency** response in excess of the identified minimum requirement.

The **Frequency** response delivered for **Frequency** deviations of less than 0.5 Hz should be no less than a figure which is directly proportional to the minimum **Frequency** response requirement for a **Frequency** deviation of 0.5 Hz. For example, if the **Frequency** deviation is 0.2 Hz, the corresponding minimum **Frequency** response requirement is 40% of the level shown in Figure CC.A.3.1. The **Frequency** response delivered for **Frequency** deviations of more than 0.5 Hz should be no less than the response delivered for a **Frequency** deviation of 0.5 Hz.

Each **Generating Unit** and/or **CCGT Module** and/or **Power Park Module** and/or **DC Converter** must be capable of providing some response, in keeping with its specific operational characteristics, when operating between 95% to 100% of **Registered Capacity** as illustrated by the dotted lines in Figure CC.A.3.1.

At the **Minimum Generation** level, each **Generating Unit** and/or **CCGT Module** and/or **Power Park Module** and/or **DC Converter** is required to provide high and low frequency response depending on the **System Frequency** conditions. Where the **Frequency** is high, the **Active Power** output is therefore expected to fall below the **Minimum Generation** level.

The **Designed Minimum Operating Level** is the output at which a **Generating Unit** and/or **CCGT Module** and/or **Power Park Module** and/or **DC Converter** has no **High Frequency Response** capability. It may be less than, but must not be more than, 55% of the **Registered Capacity**. This implies that a **Generating Unit** or **CCGT Module** or **Power Park Module** or **DC Converter** is not obliged to reduce its output to below this level unless the **Frequency** is at or above 50.5 Hz (cf BC3.7).

CC.A.3.4 TESTING OF FREQUENCY RESPONSE CAPABILITY

The response capabilities shown diagrammatically in Figure CC.A.3.1 are measured by taking the responses as obtained from some of the dynamic response tests specified by **NGET** and carried out by **Generators** and **DC Converter Station** owners for compliance purposes and to validate the content of **Ancillary Services Agreements** using an injection of a **Frequency** change to the plant control system (ie governor and load controller). The injected signal is a linear ramp from zero to 0.5 Hz **Frequency** change over a ten second period, and is sustained at 0.5 Hz **Frequency** change thereafter, as illustrated diagrammatically in figures CC.A.3.2 and CC.A.3.3.

The **Primary Response** capability (P) of a **Generating Unit** or a **CCGT Module** or **Power Park Module** or **DC Converter** is the minimum increase in **Active Power** output between 10 and 30 seconds after the start of the ramp injection as illustrated diagrammatically in Figure CC.A.3.2.

The **Secondary Response** capability (S) of a **Generating Unit** or a **CCGT Module** or **Power Park Module** or **DC Converter** is the minimum increase in **Active Power** output between 30 seconds and 30 minutes after the start of the ramp injection as illustrated diagrammatically in Figure CC.A.3.2.

The **High Frequency Response** capability (H) of a **Generating Unit** or a **CCGT Module** or **Power Park Module** or **DC Converter** is the decrease in **Active Power** output provided 10 seconds after the start of the ramp injection and sustained thereafter as illustrated diagrammatically in Figure CC.A.3.3.

CC.A.3.5 REPEATABILITY OF RESPONSE

When a **Generating Unit** or **CCGT Module** or **Power Park Module** or **DC Converter** has responded to a significant **Frequency** disturbance, its response capability must be fully restored as soon as technically possible. Full response capability should be restored no later than 20 minutes after the initial change of **System Frequency** arising from the **Frequency** disturbance.

Figure CC.A.3.1 - Minimum Frequency Response Requirement Profile
 for a 0.5 Hz frequency change from Target Frequency

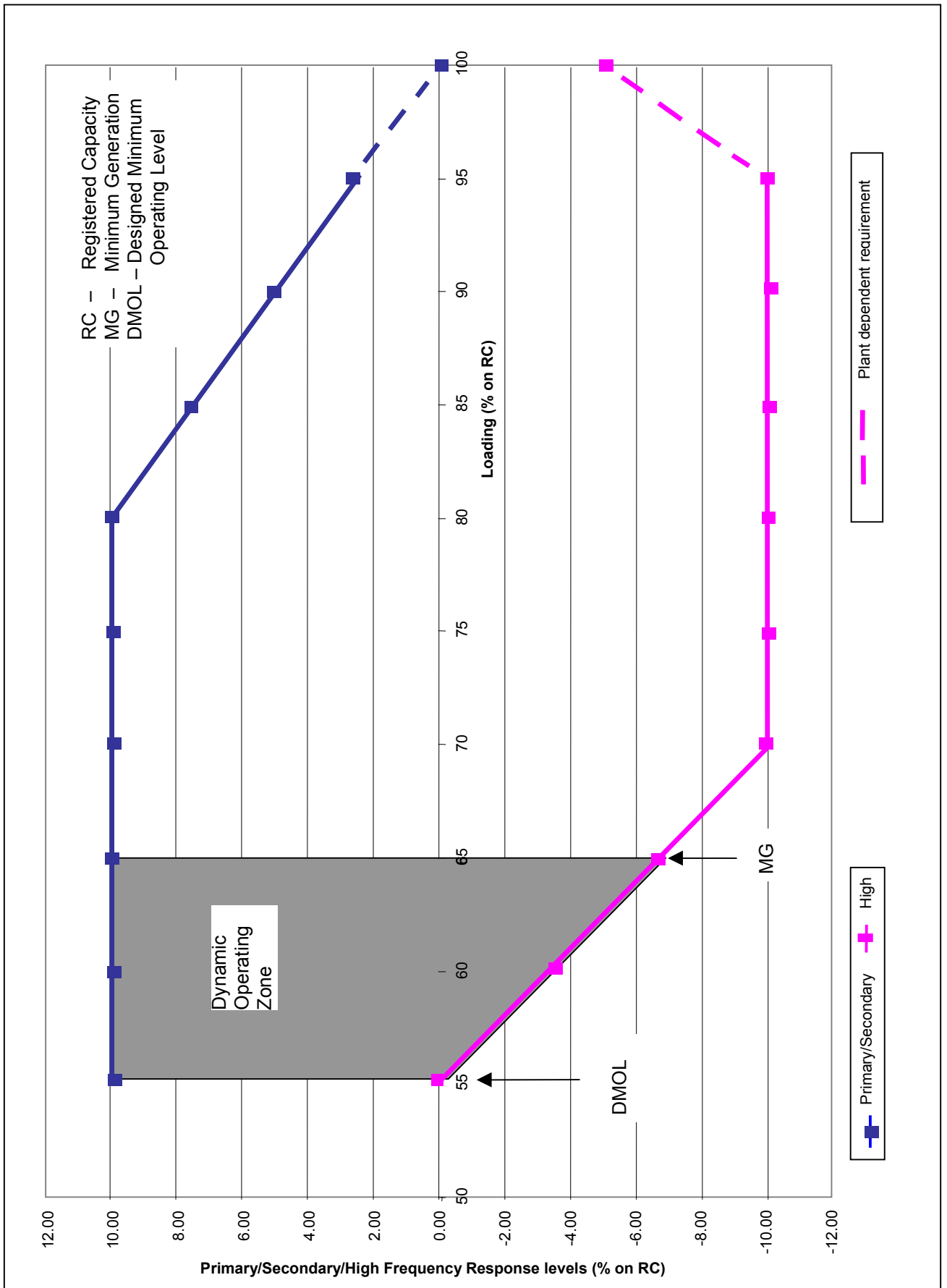

Figure CC.A.3.2 - Interpretation of Primary and Secondary Response Values

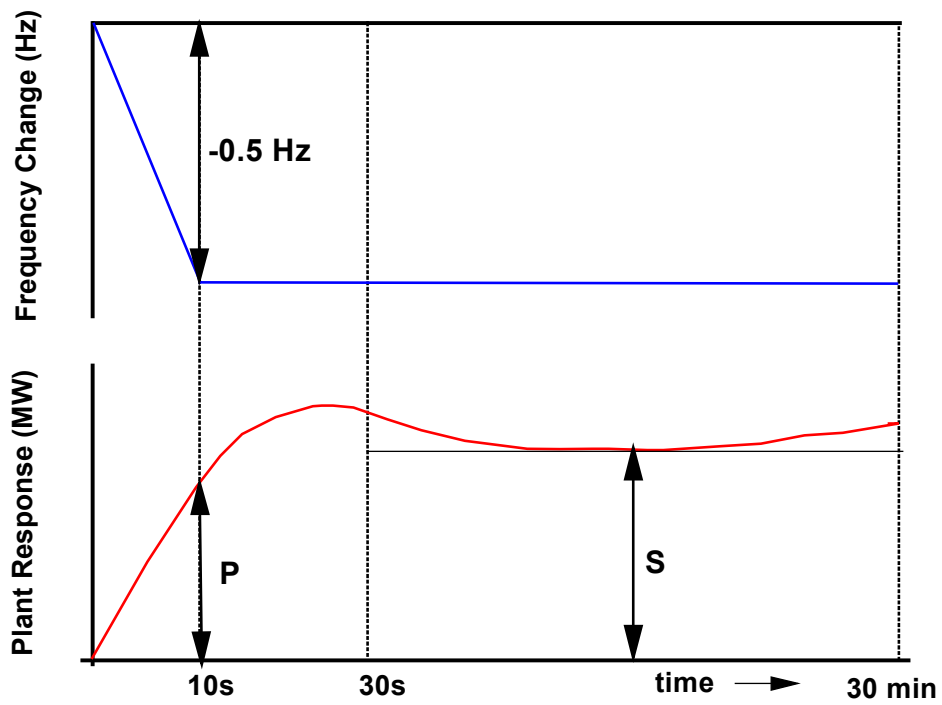
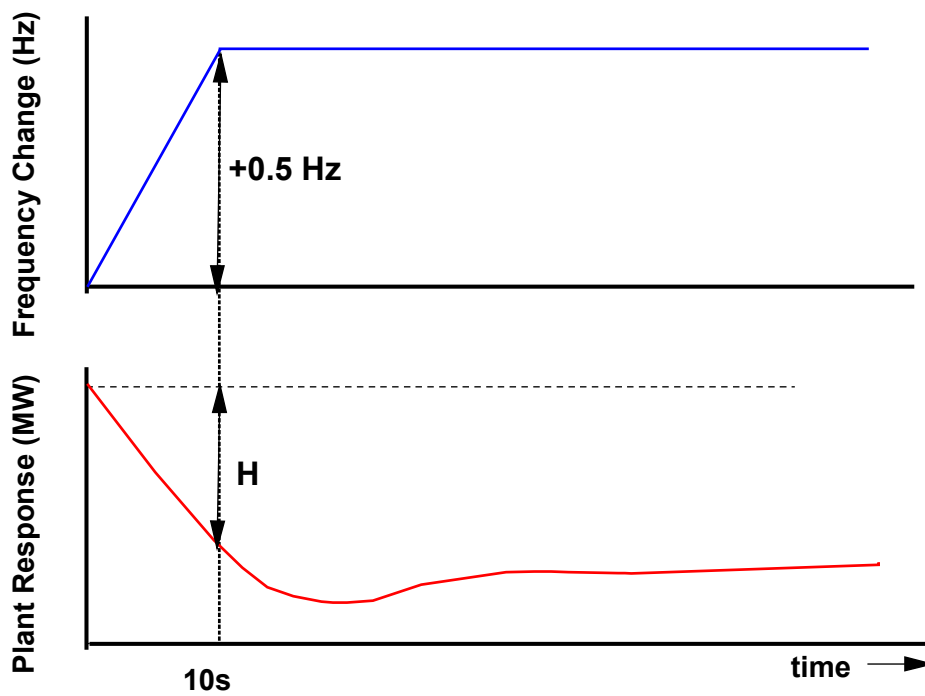

Figure CC.A.3.3 - Interpretation of High Frequency Response Values



APPENDIX 4

FAULT RIDE THROUGH REQUIREMENT FOR GENERATING UNITS, POWER PARK MODULES AND DC CONVERTERS

CC.A.4.1 SCOPE

The fault ride through requirement is defined in CC.6.3.15 (a), (b) and (c). This Appendix provides illustrations by way of examples only of CC.6.3.15 (a) (i) and further background and illustrations to CC.6.3.15 (b) (i) and is not intended to show all possible permutations.

CC.A.4.2 SHORT CIRCUIT FAULTS AT **SUPERGRID VOLTAGE** UP TO 140MS IN DURATION

For short circuit faults at **Supergrid Voltage** up to 140ms in duration, the fault ride through requirement is defined in CC.6.3.15 (a) (i). Figures CC.A.4.1 (a) and (b) illustrate two typical examples of voltage recovery for short-circuit faults cleared within 140ms by two circuit breakers (a) and three circuit breakers (b) respectively.

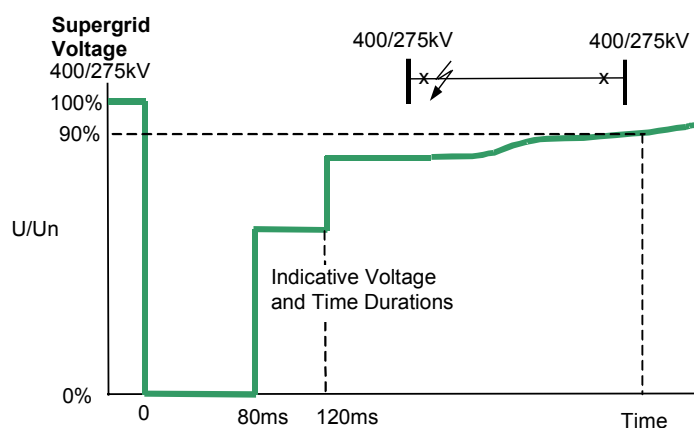

Typical fault cleared in less than 140ms: 2 ended circuit

Figure CC.A.4.1 (a)

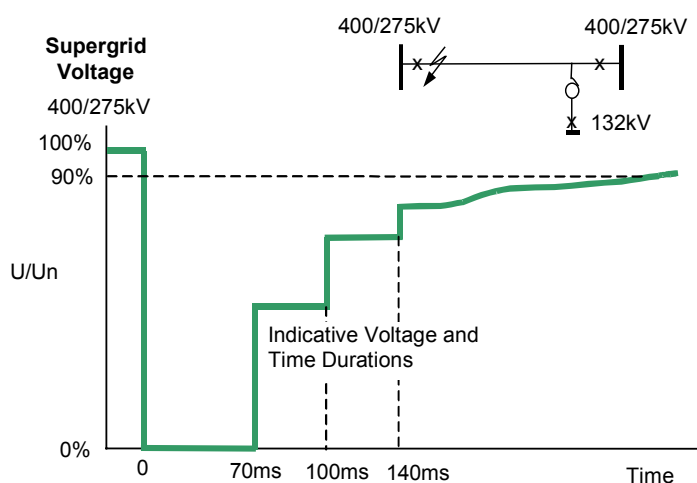

Typical fault cleared in 140ms:- 3 ended circuit

Figure CC.A.4.1 (b)

CCA.4.3 SUPERGRID VOLTAGE DIPS GREATER THAN 140MS IN DURATION

For balanced **Supergrid voltage** dips having durations greater than 140ms and up to 3 minutes the fault ride through requirement is defined in CC6.3.15 (b) (i) and Figure 5 which is reproduced in this Appendix as Figure CC.A.4.2 and termed the the voltage–duration profile.

This profile is not a voltage-time response curve that would be obtained by plotting the transient voltage response at a point on the **GB Transmission System** or **User System** to a disturbance. Rather, each point on the profile (ie the heavy black line) represents a voltage level and an associated time duration which connected **Generating Units, or Power Park Modules** must withstand or ride through.

Figures CC.A.4.3 (c), (d) and (e) illustrate the meaning of the voltage-duration profile for voltage dips having durations greater than 140ms.

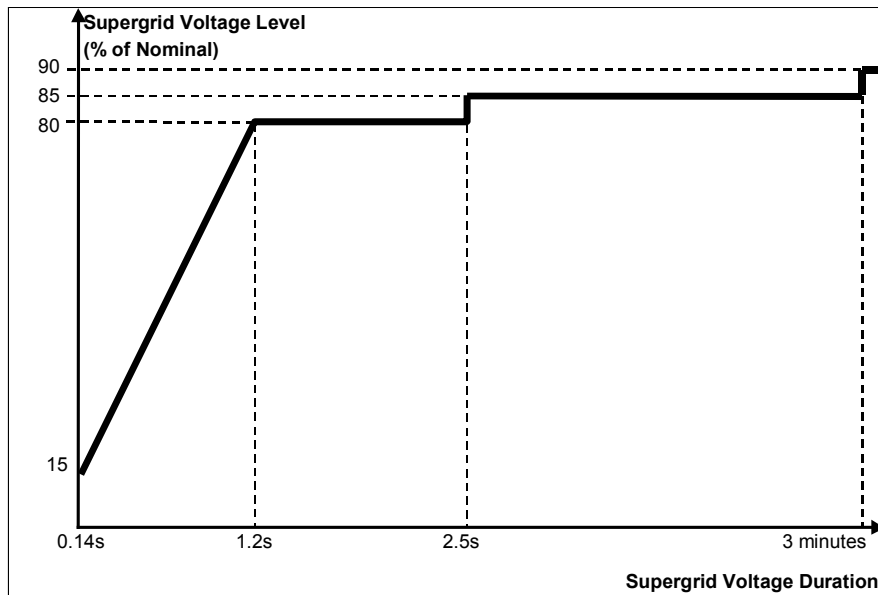
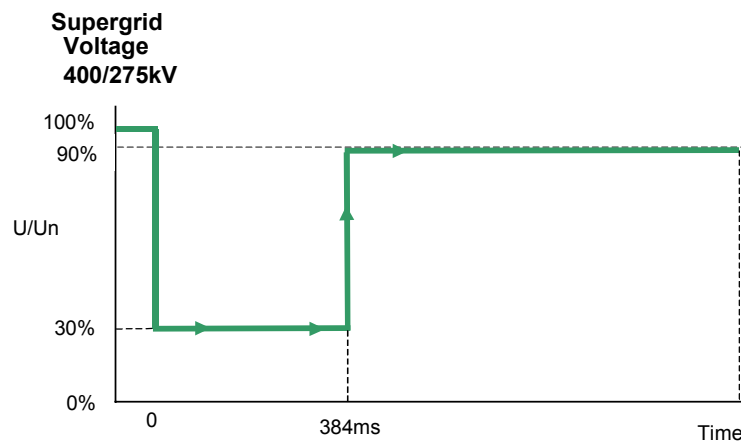
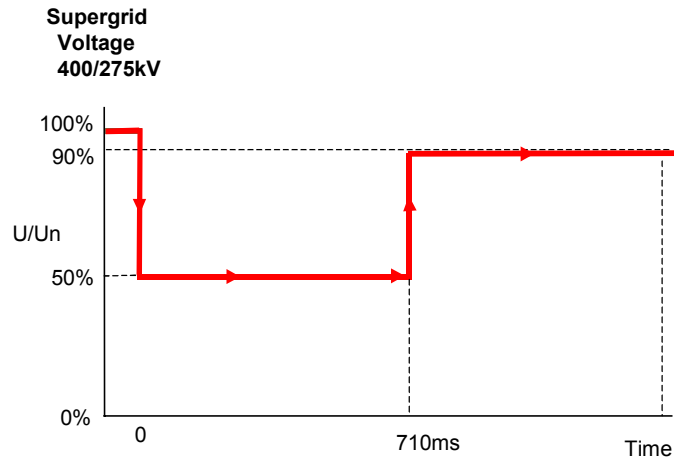

Figure CC.A.4.2



30% retained voltage, 384ms duration

Figure CC.A.4.3(a)



50% retained voltage, 710ms duration

Figure CC.A.4.3(b)

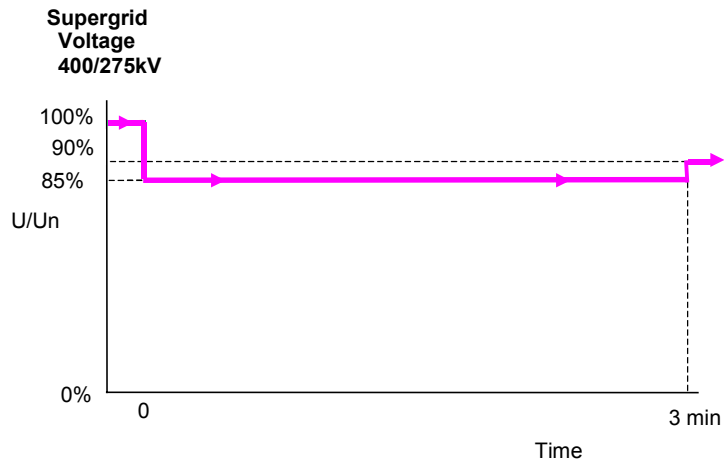

85% retained voltage, 3 minutes duration

Figure CC.A.4.3(c)

APPENDIX 5

TECHNICAL REQUIREMENTS LOW FREQUENCY RELAYS FOR THE AUTOMATIC DISCONNECTION OF SUPPLIES AT LOW FREQUENCY

CC.A.5.1

LOW FREQUENCY RELAYS

CC.A.5.1.1

The **Low Frequency Relays** to be used shall be in accordance with the requirements of the **Bilateral Agreement**. They should have a setting range of 47.0 to 50Hz and be suitable for operation from a nominal AC input of 63.5, 110 or 240V. The following general parameters on the requirements of approved **Low Frequency Relays** for automatic installations is given as an indication, without prejudice to the provisions that may be included in a **Bilateral Agreement**:

- | | | |
|-----|-------------------------------------|--|
| (a) | Frequency settings: | 47-50Hz in steps of 0.05Hz or better, preferably 0.01Hz; |
| (b) | Measurement period settings: | Within a minimum selectable settings range of 4 to 6 cycles; |
| (c) | Operating time: | Between 100 and 150ms dependent on measurement period setting; |
| (d) | Voltage lock-out: | Selectable within a range of 55 to 90% of nominal voltage; |
| (e) | Facility stages: | One or two stages of Frequency operation; |
| (f) | Output contacts: | Two output contacts per stage to be capable of repetitively making and breaking for 1000 operations. |

CC.A.5.2

LOW FREQUENCY RELAY VOLTAGE SUPPLIES

CC.A.5.2.1

It is essential that the voltage supply to the **Low Frequency Relays** shall be derived from the primary **System** at the supply point concerned so that the **Frequency** of the **Low Frequency Relays** input voltage is the same as that of the primary **System**. This requires either:

- the use of a secure supply obtained from voltage transformers directly associated with the grid transformer(s) concerned, the supply being obtained where necessary via a suitable automatic voltage selection scheme; or
- the use of the substation 240V phase-to-neutral selected auxiliary supply, provided that this supply is always derived at the supply point concerned and is never derived from a standby

supply **Generating Unit** or from another part of the **User System**.

CC.A.5.3

SCHEME REQUIREMENTS

CC.A.5.3.1

The tripping facility should be engineered in accordance with the following reliability considerations:

(a) Dependability

Failure to trip at any one particular **Demand** shedding point would not harm the overall operation of the scheme. However, many failures would have the effect of reducing the amount of **Demand** under low **Frequency** control. An overall reasonable minimum requirement for the dependability of the **Demand** shedding scheme is 96%, ie. the average probability of failure of each **Demand** shedding point should be less than 4%. Thus the **Demand** under low **Frequency** control will not be reduced by more than 4% due to relay failure.

(b) Outages

Low **Frequency Demand** shedding schemes will be engineered such that the amount of **Demand** under control is as specified by **NGET** and is not reduced unacceptably during equipment outage or maintenance conditions.

< End of CC >

OPERATING CODE NO. 1

DEMAND FORECASTS

CONTENTS

(This contents page does not form part of the Grid Code)

<u>Paragraph No/Title</u>	<u>Page Number</u>
OC1.1 INTRODUCTION.....	1
OC1.2 OBJECTIVE	2
OC1.3 SCOPE.....	2
OC1.4 DATA REQUIRED BY NGET IN THE OPERATIONAL PLANNING PHASE.....	2
OC1.5 DATA REQUIRED BY NGET IN THE PROGRAMMING PHASE, CONTROL PHASE AND POST-CONTROL PHASE.....	3
OC1.5.1 Programming Phase.....	3
OC1.5.5 Control Phase.....	3
OC1.5.6 Post-Control Phase	4
OC1.6 NGET FORECASTS.....	5

OPERATING CODE NO. 1

DEMAND FORECASTS

OC1.1 INTRODUCTION

OC1.1.1 **Operating Code No.1 ("OC1")** is concerned with **Demand** forecasting for operational purposes. In order to match generation output with **Demand** for electricity it is necessary to undertake **Demand** forecasting. It is also necessary to undertake **Demand** forecasting of **Reactive Power**.

OC1.1.2 In the **Operational Planning Phase**, **Demand** forecasting shall be conducted by **NGET** taking account of **Demand** forecasts furnished by **Network Operators** and in certain circumstances, **Generators**, who shall provide **NGET** with information in the form set out in this **OC1**. The data supplied under the **PC** is also taken into account.

OC1.1.3 In the **Programming Phase** and **Control Phase**, **NGET** will conduct its own **Demand** forecasting taking into account information to be furnished by **Suppliers**, **Network Operators** and by **Generators** and the other factors referred to in OC1.6.1.

OC1.1.4 In this **OC1**, the point of connection of the **External Interconnection** to the **GB Transmission System** shall be considered as a **Grid Supply Point**. **Reactive Power Demand** includes the series **Reactive** losses of the **User's System** but excludes any network susceptance and any **Reactive** compensation on the **User's System**. **NGET** will obtain the lumped network susceptance and details of **Reactive** compensation from the requirements to submit data under the **PC**.

OC1.1.5 Data relating to **Demand Control** should include details relating to MW.

OC1.1.6 **OC1** deals with the provision of data on **Demand Control** in the **Operational Planning Phase**, the **Programming Phase** and the **Post-Control Phase**, whereas **OC6** (amongst other things) deals with the provision of data on **Demand Control** following the **Programming Phase** and in the **Control Phase**.

OC1.1.7 In this **OC1**, Year 0 means the current **Financial Year** at any time, Year 1 means the next **Financial Year** at any time, Year 2 means the **Financial Year** after Year 1, etc.

OC1.1.8 References in **OC1** to data being supplied on a half hourly basis refer to it being supplied for each period of 30 minutes ending on the hour and half-hour in each hour.

OC1.2 OBJECTIVE

The objectives of **OC1** are to:

OC1.2.1 enable the provision of data to **NGET** by **Users** in the **Programming Phase**, **Control Phase** and **Post-Control Phase**; and

OC1.2.2 provide for the factors to be taken into account by **NGET** when **Demand** forecasting in the **Programming Phase** and **Control Phase**.

OC1.3 SCOPE

OC1 applies to **NGET** and to **Users** which in this **OC1** means:-

- (a) **Generators**,
- (b) **Network Operators**, and
- (c) **Suppliers**.

OC1.4 DATA REQUIRED BY **NGET** IN THE **OPERATIONAL PLANNING PHASE**

OC1.4.1 (a) Each **User**, as specified in (b) below, shall provide **NGET** with the data requested in OC1.4.2 below.

(b) The data will need to be supplied by:-

- (i) each **Network Operator** directly connected to the **GB Transmission System** in relation to **Demand Control**; and
- (ii) each **Generator** with respect to the output of **Medium Power Stations**.

OC1.4.2 (a) Data
By calendar week 28 each year each **Network Operator** will provide to **NGET** in writing the forecast information listed in (c) below for the current **Financial Year** and each of the succeeding five **Financial Years**.

(b) Data Providers
In circumstances when the busbar arrangement at a **Grid Supply Point** is expected to be operated in separate sections, separate sets of forecast information for each section will be provided to **NGET**.

(c) **Embedded Medium Power Station Output and Demand Control:**
For the specified time of the annual peak half hour **GB Transmission System Demand**, as specified by **NGET** under PC.A.5.2.2, the output of **Embedded Medium Power Stations** and forecasts of **Demand** to be relieved by **Demand Control** on a **Grid Supply Point** basis giving details of the amount and duration of the **Demand Control**.

OC1.5 DATA REQUIRED BY NGET IN THE PROGRAMMING PHASE, CONTROL PHASE and POST-CONTROL PHASE

OC1.5.1 Programming Phase

For the period of 2 to 8 weeks ahead the following will be supplied to **NGET** in writing by 1000 hours each Monday:

(a) **Demand Control:**

Each **Network Operator** will supply MW profiles of the amount and duration of their proposed use of **Demand Control** which may result in a **Demand** change equal to or greater than the **Demand Control Notification Level** (averaged over any half hour on any **Grid Supply Point**) on a half hourly and **Grid Supply Point** basis;

(b) **Medium Power Station Operation:**

Each **Generator** will, if reasonably required by **NGET**, supply MW schedules for the operation of **Medium Power Stations** on a half hourly and **Grid Supply Point** basis.

OC1.5.2 For the period 2 to 12 days ahead the following will be supplied to **NGET** in writing by 1200 hours each Wednesday:

(a) **Demand Control:**

Each **Network Operator** will supply MW profiles of the amount and duration of their proposed use of **Demand Control** which may result in a **Demand** change equal to or greater than the **Demand Control Notification Level** (averaged over any half hour on any **Grid Supply Point**) on a half hourly and **Grid Supply Point** basis;

(b) **Medium Power Station Operation:**

Each **Generator** will, if reasonably required by **NGET**, supply MW schedules for the operation of **Medium Power Stations** on a half hourly and **Grid Supply Point** basis.

OC1.5.3 **Medium Power Station Output:**

Each **Generator** will, if reasonably required by **NGET**, supply **NGET** with MW schedules for the operation of **Medium Power Stations** on a half hourly and **Grid Supply Point** basis in writing by 1000 hours each day (or such other time specified by **NGET** from time to time) for the next day (except that it will be for the next 3 days on Fridays and 2 days on Saturdays and may be longer (as specified by **NGET** at least one week in advance) to cover holiday periods);

OC1.5.4 Other Codes

Under **OC6** each **Network Operator** will notify **NGET** of their proposed use of **Demand Control** (which may result in a **Demand** change equal to or greater than the **Demand Control Notification Level**), and under **BC1**, each **Supplier** will notify **NGET** of their proposed use of **Customer Demand Management** (which may result in a **Demand** change equal to or greater than the **Customer Demand Management Notification Level**) in this timescale.

OC1.5.5 **Control Phase**

OC1.5.5.1 **Demand Control:**

Under **OC6**, each **Network Operator** will notify **NGET** of any **Demand Control** proposed by itself which may result in a **Demand** change equal to or greater than the **Demand Control Notification Level** averaged over any half hour on any **Grid Supply Point** which is planned after 1000 hours, and of any changes to the planned **Demand Control** notified to **NGET** prior to 1000 hours as soon as possible after the formulation of the new plans;

OC1.5.5.2 **Customer Demand Management:**

(a) Each **Supplier** will notify **NGET** of any **Customer Demand Management** proposed by itself which may result in a **Demand** change equal to or greater than the **Customer Demand Management Notification Level** averaged over any half hour on any **Grid Supply Point** which is planned to occur at any time in the **Control Phase** and of any changes to the planned **Customer Demand Management** already notified to **NGET** as soon as possible after the formulation of the new plans.

(b) The following information is required on a **Grid Supply Point** and half-hourly basis:-

(i) the proposed date, time and duration of implementation of **Customer Demand Management**; and

(ii) the proposed reduction in **Demand** by use of **Customer Demand Management**.

OC1.5.5.3 **Load Management Blocks:**

In Scotland, by 11:00 each day, each **Supplier** who controls a **Load Management Block of Demand** with a capacity of 5MW or more shall submit to **NGET** a schedule of its proposed switching times and profiles in respect of each block for the next day.

OC1.5.6 **Post-Control Phase**

The following will be supplied to **NGET** in writing by 0600 hours each day in respect of **Active Power** data and by 1000 hours each day in respect of **Reactive Power** data:

(a) **Demand Control:**

Each **Network Operator** will supply MW profiles for the previous calendar day of the amount and duration of **Demand** reduction achieved by itself from the use of **Demand Control** equal to or greater than the **Demand Control Notification Level** (averaged over any half hour on any **Grid Supply Point**), on a half hourly and **Grid Supply Point** basis.

(b) **Customer Demand Management:**

Each **Supplier** will supply MW profiles of the amount and duration of **Demand** reduction achieved by itself from the use of **Customer Demand Management** equal to or greater than the **Customer Demand Management Notification Level** (averaged over any half hour on any

Grid Supply Point) on a half hourly and **Grid Supply Point** basis during the previous calendar day.

OC1.6 **NGET FORECASTS**

OC1.6.1 The following factors will be taken into account by **NGET** when conducting **GB Transmission System Demand** forecasting in the **Programming Phase** and **Control Phase**:

- (a) Historic **Demand** data (this includes **GB Transmission System** losses).
- (b) Weather forecasts and the current and historic weather conditions.
- (c) The incidence of major events or activities which are known to **NGET** in advance.
- (d) Anticipated interconnection flows across **External Interconnections**.
- (e) **Demand Control** equal to or greater than the **Demand Control Notification Level** (averaged over any half hour at any **Grid Supply Point**) proposed to be exercised by **Network Operators** and of which **NGET** has been informed.
- (f) **Customer Demand Management** equal to or greater than the **Customer Demand Management Notification Level** (averaged over any half hour at any **Grid Supply point**) proposed to be exercised by **Suppliers** and of which **NGET** has been informed.
- (g) Other information supplied by **Users**.
- (h) Anticipated **Pumped Storage Unit** demand.
- (i) the sensitivity of **Demand** to anticipated market prices for electricity.
- (j) **BM Unit Data** submitted by **BM Participants** to **NGET** in accordance with the provisions of **BC1** and **BC2**.
- (k) **Demand** taken by **Station Transformers**

OC1.6.2 Taking into account the factors specified in OC1.6.1 **NGET** uses **Demand** forecast methodology to produce forecasts of **GB Transmission System Demand**. A written record of the use of the methodology must be kept by **NGET** for a period of at least 12 months.

OC1.6.3 The methodology will be based upon factors (a), (b) and (c) above to produce, by statistical means, unbiased forecasts of **GB National Demand**. **GB Transmission System Demand** will be calculated from these forecasts but will also take into account factors (d), (e), (f), (g), (h), (i) and (j) above. No other factors are taken into account by **NGET**, and it will base its **GB Transmission System Demand** forecasts on those factors only.

< End of OC1 >

OPERATING CODE NO.2

OPERATIONAL PLANNING AND DATA PROVISION

CONTENTS

(This contents page does not form part of the Grid Code)

<u>Paragraph No/Title</u>	<u>Page Number</u>
OC2.1 INTRODUCTION.....	1
OC2.2 OBJECTIVE	2
OC2.3 SCOPE.....	2
OC2.4 PROCEDURE	3
OC2.4.1 Co-ordination of outages.....	3
OC2.4.1.2 Planning of Genset Outages.....	3
OC2.4.1.2.1 Operational Planning Phase – Planning for Calendar Years 3 to 5 inclusive – Weekly Resolution	3
OC2.4.1.2.2 Operational Planning Phase – Planning for Calendar Year 1 and Calendar Year 2 – Weekly Resolution	7
OC2.4.1.2.3 Planning for Calendar Year 0 – Weekly Resolution	9
OC2.4.1.2.4 Programming Phase – 2-49 Days Ahead – Daily Resolution	10
OC2.4.1.3 Planning of GB Transmission System Outages	11
OC2.4.1.3.1 Operational Planning Phase – Planning for Financial Years 2 to 5 inclusive	11
OC2.4.1.3.3 Operational Planning Phase – Planning for Financial Year 1 ahead	12
OC2.4.1.3.4 Operational Planning Phase – Planning for Financial Year 0.....	15
OC2.4.1.3.5 Programming Phase.....	17
OC2.4.2 Data Requirements	18
OC2.4.3 Negative Reserve Active Power Margins	21
OC2.4.4 Frequency Sensitive Operation	24
OC2.4.6 Operating Margin Data Requirements	24
APPENDIX 1 – GENERATOR PERFORMANCE CHART.....	26
APPENDIX 2 – GENERATION PLANNING PARAMETERS.....	28
APPENDIX 3 – CCGT MODULE PLANNING MATRIX.....	30
APPENDIX 4 – POWER PARK MODULE PLANNING MATRIX.....	31

OPERATING CODE NO.2

OPERATIONAL PLANNING AND DATA PROVISION

OC2.1 INTRODUCTION

OC2.1.1 **Operating Code No. 2 ("OC2")** is concerned with:

- (a) the co-ordination of the release of **Gensets**, the **GB Transmission System** and **Network Operators' Systems** for construction, repair and maintenance;
- (b) provision by **NGET** of the **Surpluses** both for the **GB Transmission System** and **System Zones**;
- (c) the provision by **Generators** of **Generation Planning Parameters** for **Gensets**, including **CCGT Module Planning Matrices** and **Power Park Module Planning Matrices**, to **NGET** for planning purposes only; and
- (d) the agreement for release of **Existing Gas Cooled Reactor Plant** for outages in certain circumstances.

OC2.1.2 (a) **Operational Planning** involves planning, through various timescales, the matching of generation output with forecast **GB Transmission System Demand** together with a reserve of generation to provide a margin, taking into account outages of certain **Generating Units**, **Power Park Modules** and **DC Converters**, and of parts of the **GB Transmission System** and of parts of **Network Operators' Systems** which is carried out to achieve, so far as possible, the standards of security set out in **NGET's Transmission Licence**, each **Relevant Transmission Licensee's Transmission Licence** or **Electricity Distribution Licence** as the case may be.

- (b) In general terms there is an "envelope of opportunity" for the release of **Gensets** and for the release of parts of the **GB Transmission System** and parts of the **Network Operator's User Systems** for outages. The envelope is defined by the difference between the total generation output expected from **Large Power Stations**, **Medium Power Stations** and **Demand**, the operational planning margin and taking into account **External Interconnections**.

OC2.1.3 In this **OC2** for the purpose of **Generator** outage co-ordination Year 0 means the current calendar year at any time, Year 1 means the next calendar year at any time, Year 2 means the calendar year after Year 1, etc. For the purpose of **Transmission** outage planning Year 0 means the current **Financial Year** at any time, Year 1 means the next **Financial Year** at any time, Year 2 means the **Financial Year** after Year 1, etc. References to 'weeks' in **OC2** are to calendar weeks as defined in ISO 8601.

OC2.1.4 References in **OC2** to a **Generator's** "best estimate" shall be that **Generator's** best estimate acting as a reasonable and prudent **Generator** in all the circumstances.

OC2.1.5 References to **NGET** planning the **GB Transmission System** outage programme on the basis of the **Final Generation Outage Programme**, are to **NGET** planning against the **Final Generation Outage Programme** current at the time it so plans.

OC2.1.6 Where in **OC2** data is required to be submitted or information is to be given on a particular day, that data does not need to be submitted and that information does not need to be given on that day if it is not a **Business Day** or it falls within a holiday period (the occurrence and length of which shall be determined by **NGET**, in its reasonable discretion, and notified to **Users**). Instead, that data shall be submitted and/or that information shall be given on such other **Business Day** as **NGET** shall, in its reasonable discretion, determine. However, **NGET** may determine that that data and/or information need not be submitted or given at all, in which case it shall notify each **User** as appropriate.

OC2.1.7 In Scotland, it may be possible with the agreement of **NGET** to reduce the administrative burden for **Users** in producing planning information where either the output or demand is small.

OC2.2 OBJECTIVE

OC2.2.1 (a) The objective of **OC2** is to seek to enable **NGET** to harmonise outages of **Gensets** in order that such outages are co-ordinated (taking account of **Medium Power Stations**) between **Generators** and **Network Operators**, and that such outages are co-ordinated taking into account **GB Transmission System** outages and other **System** outages, so far as possible to minimise the number and effect of constraints on the **GB Transmission System** or any other **System**.

(b) In the case of **Network Operator' User Systems** directly connected to the **GB Transmission System** this means in particular that there will also need to be harmonisation of outages of **Embedded Gensets**, and **GB Transmission System** outages, with **Network Operators** in respect of their outages on those **Systems**.

OC2.2.2 The objective of **OC2** is also to enable the provision by **NGET** of the **Surpluses** both for the **GB Transmission System** and **System Zones**.

OC2.2.3 A further objective of **OC2** is to provide for the agreement for outages for **Existing Gas Cooled Reactor Plant** in certain circumstances and to enable a process to be followed in order to provide for that.

OC2.2.4 The boundaries of the **System Zones** will be determined by **NGET** from time to time taking into account the disposition of **Generators' Power Stations** within the **System Zones**. The location of the boundaries will be made available to all **Users**. Any **User** may request that **NGET** reviews any of the **System Zonal** boundaries if that **User** considers that the current boundaries are not appropriate, giving the reasons for their concerns. On receipt of such a request **NGET** will review the boundaries if, in **NGET's** reasonable opinion, such a review is justified.

OC2.3 SCOPE

- OC2.3.1 **OC2** applies to **NGET** and to **Users** which in **OC2** means:-
- (a) **Generators**, other than those which only have **Embedded Small Power Stations** or **Embedded Medium Power Stations**, (and the term **Generator** in this **OC2** shall be construed accordingly);
 - (b) **Network Operators**; and
 - (c) **Non-Embedded Customers**; and
 - (d) **DC Converter Station** owners.

OC2.4 PROCEDURE

OC2.4.1 Co-ordination of Outages

OC2.4.1.1 Under **OC2** the interaction between **NGET** and **Users** will be as follows:

- (a) Each **Generator** and **NGET** In respect of outages of **Gensets** and in respect of outages of other **Plant** and/or **Apparatus** directly connected to the **GB Transmission System**;
- (b) **NGET** and each **Generator** in respect of **GB Transmission System** outages relevant to each **Generator** (other than in respect of **Embedded Small Power Stations** or **Embedded Medium Power Stations**);
- (c) **NGET** and each **Network Operator** in respect of outages of all **Embedded Large Power Stations** and in respect of outages of other **Plant** and/or **Apparatus** relating to such **Embedded Large Power Stations**;
- (d) **NGET** and each **Network Operator** and each **Non-Embedded Customer** in respect of **GB Transmission System** outages relevant to the particular **Network Operator** or **Non-Embedded Customers**;
- (e) Each **Network Operator** and each **Non-Embedded Customer** and **NGET** in respect of **User System** outages relevant to **NGET**.

OC2.4.1.2 PLANNING OF GENSET OUTAGES

OC2.4.1.2.1 Operational Planning Phase - Planning for Calendar Years 3 to 5 inclusive – Weekly Resolution

In each calendar year:

(a) By the end of week 2

Each **Generator** will provide **NGET** in writing with:

- (i) a provisional **Genset** outage programme (covering all non-**Embedded Power Stations** and **Embedded Large Power Stations**) for Year 3 to Year 5 (inclusive) specifying the **Genset** and MW concerned, duration of proposed outages, the preferred date for each outage and where there is a possibility of flexibility, the earliest start date and latest finishing date; and
- (ii) a best estimate weekly **Output Usable** forecast of all its **Gensets** for Year 3 to Year 5.

(b) Between the end of week 2 and the end of week 12

NGET will be:

- (i) calculating total winter peak generating capacity assumed to be available to the **Total System** (taking into account the import capacity which may be available from **External Interconnections**);
- (ii) calculating the total winter peak generating capacity expected from **Large Power Stations**, taking into account **Demand** forecasts and details of proposed use of **Demand Control** received under **OC1**, and an operational planning margin set by **NGET** (the "**Operational Planning Margin**");
- (iii) calculating the weekly peak generating capacity expected from **Large Power Stations** taking into account demand forecasts and details of proposed use of **Demand Control** received under **OC1**, and the **Operational Planning Margin** and **Zonal System Security Requirements**. The total weekly peak MW needed to be available is the "weekly total MW required".

The calculation under (iii) will effectively define the envelope of opportunity for outages of **Gensets**.

During this period, **NGET** may, as appropriate, contact each **Generator** who has supplied information to seek clarification on points.

(c) By the end of week 12

NGET will:

- (i) having taken into account the information notified to it by **Generators** and taking into account:-
 - (1) **GB Transmission System** constraints and outages,
 - (2) **Network Operator System** constraints and outages, known to **NGET**, and
 - (3) the **Output Usable** required, in its view, to meet weekly total MW requirements,

provide each **Generator** in writing with any suggested amendments to the provisional outage programme supplied by the **Generator** which **NGET** believes necessary, and will advise **Generators** with **Large Power Stations** of the **Surpluses** both for the **GB Transmission System** and **System Zones** and potential export limitations, on a weekly basis, which would occur without such amendments;

- (ii) provide each **Network Operator** in writing with potential outages of **Gensets** which may, in the reasonable opinion of **NGET** and the **Network Operator**, affect the integrity of that **Network Operator's User System** provided that, in such circumstances **NGET** has notified the **Generator** concerned at least 48 hours beforehand of its intention to do so (including identifying the **Genset** concerned).

(d) By the end of week 14

- (i) Where a **Generator** or a **Network Operator** is unhappy with the suggested amendments to its provisional outage programme (in the case of a **Generator**) or such potential outages (in the case of a **Network Operator**) it may contact **NGET** to explain its concerns and **NGET** and that **Generator** or **Network Operator** will then discuss the problem and seek to resolve it.
- (ii) The possible resolution of the problem may require **NGET** or a **User** to contact other **Generators** and **Network Operators**, and joint meetings of all parties may, if any **User** feels it would be helpful, be convened by **NGET**. The need for further discussions, be they on the telephone or at meetings, can only be determined at the time.

(e) By the end of week 25

Each **Generator** will provide **NGET** in writing with an updated provisional **Genset** outage programme covering both **Embedded** and non-**Embedded Large Power Stations** together with the best estimate weekly **Output Usable** forecasts for each **Genset**, in all cases for Year 3 to Year 5 (inclusive). The updated provisional **Genset** outage programme will contain the MW concerned, duration of proposed outages, the preferred date for each outage and, where applicable, earliest start date and latest finishing date, together with an update of the **Output Usable** estimate supplied under (a)(ii) above.

(f) Between the end of week 25 and the end of week 28

NGET will be considering the updated provisional **Genset** outage programme, together with the best estimate weekly **Output Usable** forecasts supplied to it by **Generators** under (e) and their **Registered Capacity** and will be analysing **Operational Planning Margins** for the period.

(g) By the end of week 28

NGET will:

- (i) provide each **Generator** in writing with details of any suggested revisions considered by **NGET** as being necessary to the updated provisional **Genset** outage programme supplied to **NGET** under (e) and will advise **Generators** with **Large Power Stations** of the **Surpluses** for the **GB Transmission System** and **System Zones** and potential export limitations on a weekly basis which would occur without such revisions; and
- (ii) provide each **Network Operator** in writing with the update of potential outages of **Gensets** which, in the reasonable opinion of **NGET** and the **Network Operator**, affect the integrity of that **Network Operator's User System**.

(h) By the end of week 31

Where a **Generator** or a **Network Operator** is unhappy with the revisions suggested to the updated provisional **Genset** outage programme (in the case of a **Generator**) or such update of potential outages (in the case of a **Network Operator**) under (g) it may contact **NGET** to explain its concerns and the provisions set out in (d) above will apply to that process.

(i) By the end of week 42

NGET will:

- (1) provide each **Generator** in writing with details of suggested revisions considered by **NGET** as being necessary to the updated provisional **Genset** outage programme supplied to **NGET** and will advise **Generators** with **Large Power Stations** of the **Surpluses** for the **GB Transmission System** and **System Zones** and potential export limitations, on a weekly basis which would occur without such revisions;
- (2) provide each **Network Operator** in writing with the update of potential outages of **Gensets** which may, in the reasonable opinion of **NGET** and the **Network Operator**, affect the integrity of that **Network Operator's User System** provided that, in such circumstances **NGET** has notified the **Generator** concerned at least 48 hours beforehand of its intention to do so (including identifying the **Gensets** concerned).

(j) By the end of week 45

NGET will seek to agree a **Final Generation Outage Programme** for Year 3 to Year 5. If agreement cannot be reached on all aspects, **NGET** and each **Generator** will record their agreement on as many aspects as have been agreed and **NGET** will advise each **Generator** with **Large Power Stations** and each **Network Operator**, of the **Surpluses** for the **GB Transmission System** and **System Zones** on a weekly basis which would occur in relation to those aspects not agreed. It is accepted that agreement of the **Final Generation Outage Programme** is not a commitment on **Generators** or **NGET** to abide by it, but **NGET** will be planning the **GB Transmission System** outage programme on the basis of the **Final Generation Outage Programme** and if in the event the **Generator's** outages differ from those contained in the **Final Generation Outage Programme**, or in

any way conflict with the **GB Transmission System** outage programme, **NGET** need not alter the **GB Transmission System** outage programme.

OC2.4.1.2.2 **Operational Planning Phase - Planning for Calendar Year 1 and Calendar Year 2 – Weekly Resolution**

The basis for **Operational Planning** for Year 1 and Year 2 will be the **Final Generation Outage Programmes** agreed for Years 2 and 3:

In each calendar year:

(a) **By the end of week 10**

Each **Generator** will provide **NGET** in writing with its previously agreed **Final Generation Outage Programme** updated and best estimate weekly **Output Usable** forecasts for each **Genset** for weeks 1-52 of Years 1 and 2.

(b) **Between the end of week 10 and the end of week 12**

NGET will be considering the updated proposed **Genset** outage programme together with the estimate of **Output Usable** supplied by **Generators** under (a) and will be analysing **Operational Planning Margins** for the period. Taking these into account together with **GB Transmission System** constraints and outages and **Network Operator User System** constraints and outages known to **NGET**, **NGET** will assess whether the estimates of **Output Usable** supplied by **Generators** are sufficient to meet forecast **GB Transmission System Demand** plus the **Operational Planning Margin**.

(c) **By the end of week 12**

NGET will:

(i) notify each **Generator** in writing whether the **Output Usable** estimates are adequate for weeks 1-52 of Years 1 and 2, together with suggested changes to its **Final Generation Outage Programme** where necessary and will advise each **Generator** with **Large Power Stations** of the **Surpluses** both for the **GB Transmission System** and **System Zones** and potential export limitations, on a weekly resolution which would occur without such changes;

(ii) provide each **Network Operator** in writing with weekly **Output Usable** estimates of **Generators** for weeks 1-52 of Years 1 and 2, and updated details of potential outages, in each case relating to **Gensets** which may, in the reasonable opinion of **NGET** and the **Network Operator**, affect the integrity of that **Network Operator's User System** provided that, in such circumstances, **NGET** has notified the **Generator** concerned at least 48 hours beforehand of its intention to do so (including identifying the **Gensets** concerned).

(d) **By the end of week 14**

Where a **Generator** or a **Network Operator** is unhappy with any suggested changes to its **Final Generation Outage Programme** (in the case of a **Generator**) or such update of potential outages (in the case of a **Network Operator**), equivalent provisions to those set out in OC2.4.1.2.1(d) will apply.

(e) By the end of week 34

Each **Generator** will provide **NGET** in writing with revised best estimate weekly **Output Usable** forecasts for each **Genset** for weeks 1-52 of Years 1 and 2.

(f) Between the end of week 34 and the end of week 39

NGET will be analysing the revised estimates of **Output Usable** supplied by **Generators** under (e) and will be analysing **Operational Planning Margins** for the period. Taking these into account together with **GB Transmission System** constraints and outages and **Network Operator User System** constraints and outages known to **NGET**, **NGET** will assess whether the estimates of **Output Usable** supplied by **Generators** are sufficient to meet forecast **GB Transmission System Demand** plus the **Operational Planning Margin**.

(g) By the end of week 39

NGET will:

(i) notify each **Generator** in writing whether it accepts the **Output Usable** estimates for weeks 1-52 of Years 1 and 2, and of any suggested changes to its **Final Generation Outage Programme** where necessary and will advise **Generators** with **Large Power Stations** of the **Surpluses** both for the **GB Transmission System** and **System Zones** and potential export limitations on a weekly basis which would occur without such changes;

(ii) provide each **Network Operator** in writing with **Output Usable** estimates of **Generators** for weeks 1-52 of Years 1 and 2, and updated details of potential outages, in each case relating to **Gensets** which may, in the reasonable opinion of **NGET** and the **Network Operator**, affect the integrity of that **Network Operator's User System** provided that, in such circumstances, **NGET** has notified the **Generator** concerned at least 48 hours beforehand of its intention to do so (including identifying the **Gensets** concerned).

(h) By the end of week 46

Where a **Generator** or a **Network Operator**, is unhappy with any suggested changes to its **Final Generation Outage Programme** (in the case of a **Generator**) or such update of potential outages (in the case of a **Network Operator**), equivalent provisions to those set out in OC2.4.1.2.1(d) will apply.

(i) By the end of week 48

NGET will seek to agree the revised **Final Generation Outage Programme** for Year 1 and Year 2. If agreement cannot be reached on all aspects, **NGET** and each **Generator** will record their agreement on as many aspects as have been agreed and **NGET** will advise each **Generator** with **Large Power Stations** and each **Network Operator**, of **Generating Plant Demand Margins** for national and zonal groups, on a weekly basis, which would occur in relation to those aspects not agreed. It is accepted that agreement of the **Final Generation Outage Programme** is not a commitment on **Generators** or **NGET** to abide by it, but **NGET** will be planning the **GB Transmission System** outage programme on the basis of the **Final Generation Outage Programme** and if, in the event, a **Generator's** outages differ from those contained in the **Final Generation Outage Programme**, or in any way conflict with the **GB Transmission System** outage programme, **NGET** need not alter the **GB Transmission System** outage programme.

OC2.4.1.2.3 Planning for Calendar Year 0 – Weekly Resolution

The basis for **Operational Planning** for Year 0 will be the revised **Final Generation Outage Programme** agreed for Year 1:

In each week:

(a) By 1600 hours each Wednesday – Weekly Resolution

Each **Generator** will provide **NGET** in writing with an update of the **Final Generation Outage Programme** and a best estimate weekly **Output Usable** forecast for each of its **Gensets** from the 2nd week ahead to the 52nd week ahead.

(b) Between 1600 hours Wednesday and 1600 hours Friday

NGET will be analysing the revised estimates of **Output Usable** supplied by **Generators** under (a) and will be analysing **Operational Planning Margins** for the period. Taking into account **GB Transmission System** constraints and outages and **Network Operator User System** constraints and outages known to **NGET**, **NGET** will assess whether the estimates of **Output Usable** supplied by **Generators** are sufficient to meet forecast **GB Transmission System Demand** plus the **Operational Planning Margin**.

(c) By 1600 hours each Friday

NGET will:

- (i) notify each **Generator** with **Large Power Stations** and **Network Operator**, in writing if it considers the **Output Usable** forecasts will give **Surpluses** and potential export limitations both for the **GB Transmission System** and **System Zones** from the 2nd week ahead to the 52nd week ahead;
- (ii) provide each **Network Operator**, in writing with weekly **Output Usable** estimates from the 2nd week ahead to the 52nd week ahead and updated outages, each relating to **Gensets** which may, in the reasonable opinion of **NGET** and the **Network Operator**, affect the integrity of that **Network Operator's User System** and in such

circumstances, **NGET** shall notify the **Generator** concerned within 48 hours of so providing (including identifying the **Gensets** concerned), from the 2nd week ahead to the 52nd week ahead.

OC2.4.1.2.4 Programming Phase – 2-49 Days Ahead – Daily Resolution

(a) By 1200 hours each Friday

NGET will notify in writing each **Generator** with **Large Power Stations** and **Network Operator** if it considers the **Output Usable** forecasts will give MW shortfalls both nationally and for constrained groups for the period 2-7 weeks ahead.

(b) By 1100 hours each Business Day

Each **Generator** shall provide **NGET** in writing with the best estimate of daily **Output Usable** for each **Genset** for the period from and including day 2 ahead to day 14 ahead, including the forecast return to service date for any such **Generating Unit** or **Power Park Module** subject to **Planned Outage** or breakdown.

(c) By 1100 hours each Wednesday

For the period 2 to 49 days ahead, every Wednesday by 11:00 hours, each **Generator** shall provide **NGET** in writing best estimate daily **Output Usable** forecasts for each **Genset**, and changes (start and finish dates) to **Planned Outage** or to the return to service times of each **Genset** which is subject to breakdown.

(d) Between 1100 hours and 1600 hours each Business Day

NGET will be analysing the revised estimates of **Output Usable** supplied by **Generators** under (b) and will be analysing **Operational Planning Margins** for the period 2-14 days ahead. Taking into account **GB Transmission System** constraints and outages and **Network Operator User System** constraints and outages known to **NGET**, **NGET** will assess whether the estimates of **Output Usable** are sufficient to meet forecast **GB Transmission System Demand** plus the **Operational Planning Margin**.

(e) By 1600 hours each Business Day

(i) **NGET** will notify in writing each **Generator** with **Large Power Stations** and each **Network Operator**, of the **Surpluses** both for the **GB Transmission System** and **System Zones** and potential export limitations, for the period from and including day 2 ahead to day 14 ahead which it considers the **Output Usable** forecasts will give. The time of 1600 hours can only be met in respect of any **Generator** or **Network Operator** if all the information from all **Generators** was made available to **NGET** by 1100 hours and if a suitable electronic data transmission facility is in place between **NGET** and the **Generator** or the **Network Operator**, as the case may be, and if it is

fully operational. In the event that any of these conditions is not met, or if it is necessary to revert to a manual system for analysing the information supplied and otherwise to be considered, **NGET** reserve the right to extend the timescale for issue of the information required under this sub-paragraph to each, or the relevant, **Generator** and/or **Network Operator** (as the case may be) provided that such information will in any event be issued by 1800 hours.

- (ii) **NGET** will provide each **Network Operator**, where it has an effect on that **User**, in writing with **Output Usable** estimates from and including day 2 ahead to day 14 ahead and updated outages, each relating to **Gensets** which are either in its **User System** or which may, in the reasonable opinion of **NGET** and the **Network Operator**, affect the integrity of that **Network Operator's User System** and in such circumstances, **NGET** shall notify the **Generator** concerned within 48 hours of so providing (including identifying the **Gensets** concerned), for the period from and including day 2 ahead to day 14 ahead.

OC2.4.1.3 Planning of **GB Transmission System** Outages

OC2.4.1.3.1 Operational Planning Phase - Planning for **Financial Years** 2 to 5 inclusive ahead

NGET shall plan **GB Transmission System** outages required in Years 2 to 5 inclusive required as a result of construction or refurbishment works. This contrasts with the planning of **GB Transmission System** outages required in Years 0 and 1 ahead, when **NGET** also takes into account **GB Transmission System** outages required as a result of maintenance.

Users should bear in mind that **NGET** will be planning the **GB Transmission System** outage programme on the basis of the previous year's **Final Generation Outage Programme** and if in the event a **Generator's** or **Network Operator's** outages differ from those contained in the **Final Generation Outage Programme**, or in the case of **Network Operators**, those known to **NGET**, or in any way conflict with the **GB Transmission System** outage programme, **NGET** need not alter the **GB Transmission System** outage programme.

OC2.4.1.3.2 In each calendar year:

- (a) By the end of week 8

Each **Network Operator** will notify **NGET** in writing of details of proposed outages in Years 2-5 ahead in its **User System** which may affect the performance of the **Total System** (which includes but is not limited to outages of **User System Apparatus** at **Grid Supply Points** and outages which constrain the output of **Gensets Embedded** within that **User System**).

(b) By the end of week 13

Each **Generator** will inform **NGET** in writing of proposed outages in Years 2 - 5 ahead of **Generator** owned **Apparatus** (eg. busbar selectors) other than **Gensets**, at each **Grid Entry Point**.

NGET will provide to each **Network Operator** and to each **Generator** a copy of the information given to **NGET** under paragraph (a) above (other than the information given by that **Network Operator**). In relation to a **Network Operator**, the data must only be used by that **User** in operating that **Network Operator's User System** and must not be used for any other purpose or passed on to, or used by, any other business of that **User** or to, or by, any person within any other such business or elsewhere.

(c) By the end of week 28

NGET will provide each **Network Operator** in writing with details of proposed outages in Years 2-5 ahead which may, in **NGET's** reasonable judgement, affect the performance of that **Network Operator's User System**.

(d) By the end of week 30

Where **NGET** or a **Network Operator** is unhappy with the proposed outages notified to it under (a), (b) or (c) above, as the case may be, equivalent provisions to those set out in OC2.4.1.2.1 (d) will apply.

(e) By the end of week 34

NGET will draw up a draft **GB Transmission System** outage plan covering the period Years 2 to 5 ahead and **NGET** will notify each **Generator** and **Network Operator** in writing of those aspects of the plan which may operationally affect such **Generator** (other than those aspects which may operationally affect **Embedded Small Power Stations** or **Embedded Medium Power Stations**) or **Network Operator**. **NGET** will also indicate where a need may exist to issue other operational instructions or notifications (including but not limited to the requirement for the arming of an **Operational Intertripping** scheme) or **Emergency Instructions to Users** in accordance with **BC2** to allow the security of the **GB Transmission System** to be maintained within the **Licence Standards**.

OC2.4.1.3.3 Operational Planning Phase - Planning for Financial Year 1 ahead

Each calendar year **NGET** shall update the draft **GB Transmission System** outage plan prepared under OC2.4.1.3.2 above and shall in addition take into account outages required as a result of maintenance work.

In each calendar year:

(a) By the end of week 13

Generators and **Non-Embedded Customers** will inform **NGET** in writing of proposed outages for Year 1 of **Generator** owned **Apparatus** at each **Grid Entry Point** (e.g. busbar selectors) other than **Gensets** or **Non-**

Embedded Customer owned **Apparatus**, as the case may be, at each **Grid Supply Point**.

- (b) By the end of week 28

NGET will provide each **Network Operator** and each **Non-Embedded Customer** in writing with details of proposed outages in Year 1 ahead which may, in **NGET's** reasonable judgement, affect the performance of its **User System** or the **Non-Embedded Customer Apparatus** at the **Grid Supply Point**.

- (c) By the end of week 32

Each **Network Operator** will notify **NGET** in writing with details of proposed outages in Year 1 in its **User System** which may affect the performance of the **Total System** (which includes but is not limited to outages of **User System Apparatus** at **Grid Supply Points** and outages which constrain the output of **Gensets Embedded** within that **User System**).

- (d) Between the end of week 32 and the end of week 34

NGET will draw up a revised **GB Transmission System** outage plan (which for the avoidance of doubt includes **Transmission Apparatus** at the **Connection Points**).

- (e) By the end of week 34

NGET will notify each **Generator** and **Network Operator**, in writing, of those aspects of the **GB Transmission System** outage programme which may, in **NGET's** reasonable opinion, operationally affect that **Generator** (other than those aspects which may operationally affect **Embedded Small Power Stations** or **Embedded Medium Power Stations**) or **Network Operator** including in particular proposed start dates and end dates of relevant **GB Transmission System** outages.

NGET will provide to each **Network Operator** and to each **Generator** a copy of the information given to **NGET** under paragraph (c) above (other than the information given by that **Network Operator**). In relation to a **Network Operator**, the data must only be used by that **User** in operating that **Network Operator's User System** and must not be used for any other purpose or passed on to, or used by, any other business of that **User** or to, or by, any person within any other such business or elsewhere.

- (f) By the end of week 36

Where a **Generator** or **Network Operator** is unhappy with the proposed aspects notified to it under (e) above, equivalent provisions to those set out in OC2.4.1.2.1 (d) will apply.

- (g) Between the end of week 34 and 49

NGET will draw up a final **GB Transmission System** outage plan covering Year 1.

(h) By the end of week 49

- (i) **NGET** will complete the final **GB Transmission System** outage plan for Year 1. The plan for Year 1 becomes the final plan for Year 0 when by expiry of time Year 1 becomes Year 0.
- (ii) **NGET** will notify each **Generator** and each **Network Operator** in writing of those aspects of the plan which may operationally affect such **Generator** (other than those aspects which may operationally affect **Embedded Small Power Stations** or **Embedded Medium Power Stations**) or **Network Operator** including in particular proposed start dates and end dates of relevant **GB Transmission System** outages. **NGET** will also indicate where a need may exist to issue other operational instructions or notifications (including but not limited to the requirement for the arming of an **Operational Intertripping** scheme) or **Emergency Instructions to Users** in accordance with **BC2** to allow the security of the **GB Transmission System** to be maintained within the **Licence Standards**. **NGET** will also inform each relevant **Non-Embedded Customer** of the aspects of the plan which may affect it.
- (iii) In addition, in relation to the final **GB Transmission System** outage plan for Year 1, **NGET** will provide to each **Generator** a copy of the final **GB Transmission System** outage plan for that year. OC2.4.1.3.4 contains provisions whereby updates of the final **GB Transmission System** outage plan are provided. The plan and the updates will be provided in writing. It should be noted that the final **GB Transmission System** outage plan for Year 1 and the updates will not give a complete understanding of how the **GB Transmission System** will operate in real time, where the **GB Transmission System** operation may be affected by other factors which may not be known at the time of the plan and the updates. Therefore, **Users** should place no reliance on the plan or the updates showing a set of conditions which will actually arise in real time.

(i) Information Release or Exchange

This paragraph (i) contains alternative requirements on **NGET**, paragraph (z) being an alternative to a combination of paragraphs (x) and (y). Paragraph (z) will only apply in relation to a particular **User** if **NGET** and that **User** agree that it should apply, in which case paragraphs (x) and (y) will not apply. In the absence of any relevant agreement between **NGET** and the **User**, **NGET** will only be required to comply with paragraphs (x) and (y).

Information Release to each **Network Operator** and **Non-Embedded Customer**

Between the end of Week 34 and 49 **NGET** will upon written request:

- (x) for radial systems, provide each **Network Operator** and **Non Embedded Customer** with data to allow the calculation by the **Network Operator**, and each **Non Embedded Customer**, of symmetrical and asymmetrical fault levels; and

- (y) for interconnected **Systems**, provide to each **Network Operator** an equivalent network, sufficient to allow the identification of symmetrical and asymmetrical fault levels, and power flows across interconnecting **User Systems** directly connected to the **GB Transmission System**;
or

System Data Exchange

- (z) as part of a process to facilitate understanding of the operation of the **Total System**,

- (1) **NGET** will make available to each **Network Operator**, the **GB Transmission System Study Network Data Files** covering Year 1 which are of relevance to that **User's System**;

- (2) where **NGET** and a **User** have agreed to the use of data links between them, the making available will be by way of allowing the **User** access to take a copy of the **GB Transmission System Study Network Data Files** once during that period. The **User** may, having taken that copy, refer to the copy as often as it wishes. Such access will be in a manner agreed by **NGET** and may be subject to separate agreements governing the manner of access. In the absence of agreement, the copy of the **GB Transmission System Study Network Data Files** will be given to the **User** on a disc, or in hard copy, as determined by **NGET**;

- (3) the data contained in the **GB Transmission Study Network Data Files** represents **NGET's** view of indicative operating conditions only and should be used for technical analysis only on the basis that it only represents a view and that operating conditions may be different in the event;

- (4) **NGET** will notify each **Network Operator**, as soon as reasonably practicable after it has updated the **GB Transmission System Study Network Data Files** covering Year 1 that it has done so, when this update falls before the next annual update under this OC2.4.1.3.3(i). **NGET** will then make available to each **Network Operator** who has received an earlier version (and in respect of whom the agreement still exists), the updated **GB Transmission System Study Network Files** covering the balance of Years 1 and 2 which remain given the passage of time, and which are of relevance to that **User's System**. The provisions of paragraphs (2) and (3) above shall apply to the making available of these updates;

- (5) the data from the **GB Transmission System Study Network Data Files** received by each **Network Operator** must only be used by that **User** in operating that **Network Operator's User System** and must not be used for any other purpose or passed on to, or used by, any other business of that **User** or to, or by, any person within any other such business or elsewhere.

OC2.4.1.3.4 Operational Planning Phase - Planning in Financial Year 0 down to the Programming Phase (and in the case of load transfer capability, also during the Programming Phase)

- (a) The **GB Transmission System** outage plan for Year 1 issued under OC2.4.1.3.3 shall become the plan for Year 0 when by expiry of time Year 1 becomes Year 0.
- (b) Each **Generator** or **Network Operator** or **Non-Embedded Customer** may at any time during Year 0 request **NGET** in writing for changes to the outages requested by them under OC2.4.1.3.3. In relation to that part of Year 0, excluding the period 1-7 weeks from the date of request, **NGET** shall determine whether the changes are possible and shall notify the **Generator**, **Network Operator** or **Non-Embedded Customer** in question whether this is the case as soon as possible, and in any event within 14 days of the date of receipt by **NGET** of the written request in question.

Where **NGET** determines that any change so requested is possible and notifies the relevant **User** accordingly, **NGET** will provide to each **Network Operator** and each **Generator** a copy of the request to which **NGET** has agreed which relates to outages on **Systems of Network Operators** (other than any request made by that **Network Operator**). The information must only be used by that **Network Operator** in operating that **Network Operator's User System** and must not be used for any other purpose or passed on to, or used by, any other business of that **User** or to, or by, any person within any other such business or elsewhere.

- (c) During Year 0 (including the **Programming Phase**) each **Network Operator** shall at **NGET's** request make available to **NGET** such details of automatic and manual load transfer capability of:
 - (i) 12MW or more (averaged over any half hour) for England and Wales
 - (ii) 10MW or more (averaged over any half hour) for Scotland

between **Grid Supply Points**.

- (d) When necessary during Year 0, **NGET** will notify each **Generator** and **Network Operator** and each **Non-Embedded Customer**, in writing of those aspects of the **GB Transmission System** outage programme in the period from the 8th week ahead to the 52nd week ahead, which may, in **NGET's** reasonable opinion, operationally affect that **Generator** (other than those aspects which may operationally affect **Embedded Small Power Stations** or **Embedded Medium Power Stations**) or **Network Operator** or **Non-Embedded Customer** including in particular proposed start dates and end dates of relevant **GB Transmission System** outages.

NGET will also notify changes to information supplied by **NGET** pursuant to OC2.4.1.3.3(i)(x) and (y) except where in relation to a **User** information was supplied pursuant to OC2.4.1.3.3(i)(z). In that case:-

- (i) **NGET** will, by way of update of the information supplied by it pursuant to OC2.4.1.3.3(i)(z), make available at the first time in Year 0 that it updates the **GB Transmission System Study Network Data Files** in respect of Year 0 (such update being an update on what was shown in respect of Year 1 which has then become Year 0) to each **Network Operator** who has received an earlier version under OC2.4.1.3.3(i)(z) (and in respect of whom the agreement still exists), the **GB Transmission System Study Network Data Files** covering Year 0 which are of relevance to that **User's System**.

- (ii) **NGET** will notify each relevant **Network Operator**, as soon as reasonably practicable after it has updated the **GB Transmission System Study Network Data Files** covering Year 0, that it has done so. **NGET** will then make available to each such **Network Operator**, the updated **GB Transmission System Study Network Data Files** covering the balance of Year 0 which remains given the passage of time, and which are of relevance to that **User's System**.
- (iii) The provisions of OC2.4.1.3.3(i)(z)(2), (3) and (5) shall apply to the provision of data under this part of OC2.4.1.3.4(d) as if set out in full.

NGET will also indicate where a need may exist to issue other operational instructions or notifications (including but not limited to the requirement for the arming of an **Operational Intertripping** scheme) or **Emergency Instructions to Users** in accordance with **BC2** to allow the security of the **GB Transmission System** to be maintained within the **Licence Standards**.

- (e) In addition, by the end of each month during Year 0, **NGET** will provide to each **Generator** a notice containing any revisions to the final **GB Transmission System** outage plan for Year 1, provided to the **Generator** under OC2.4.1.3.3 or previously under this provision, whichever is the more recent.

OC2.4.1.3.5 Programming Phase

- (a) By 1600 hours each Thursday
 - (i) **NGET** shall continue to update a preliminary **GB Transmission System** outage programme for the eighth week ahead, a provisional **GB Transmission System** outage programme for the next week ahead and a final day ahead **GB Transmission System** outage programme for the following day.
 - (ii) **NGET** will notify each **Generator** and **Network Operator** and each **Non-Embedded Customer**, in writing of those aspects of the preliminary **GB Transmission System** outage programme which may operationally affect each **Generator** (other than those aspects which may operationally affect **Embedded Small Power Stations** or **Embedded Medium Power Stations**) or **Network Operator** and each **Non-Embedded Customer** including in particular proposed start dates and end dates of relevant **GB Transmission System** outages and changes to information supplied by **NGET** pursuant to OC2.4.1.3.3(i)(x) and (y) (if OC2.4.1.3.3(i)(z) does not apply).

NGET will also indicate where a need may exist to arm an **Operational Intertripping** scheme, emergency switching, emergency **Demand** management or other measures including the issuing of other operational instructions or notifications or **Emergency Instructions to Users** in accordance with **BC2** to allow the security of the **GB Transmission System** to be maintained within the **Licence Standards**.

- (b) By 1000 hours each Friday

Generators and Network Operators will discuss with **NGET** and confirm in writing to **NGET**, acceptance or otherwise of the requirements detailed under OC2.4.1.3.5.

- (c) By 1600 hours each Friday
- (i) **NGET** shall finalise the preliminary **GB Transmission System** outage programme up to the seventh week ahead. **NGET** will endeavour to give as much notice as possible to a **Generator** with nuclear **Large Power Stations** which may be operationally affected by an outage which is to be included in such programme.
 - (ii) **NGET** shall finalise the provisional **GB Transmission System** outage programme for the next week ahead.
 - (iii) **NGET** shall finalise the **GB Transmission System** outage programme for the weekend through to the next normal working day.
 - (iv) In each case **NGET** will indicate the factors set out in (a)(ii) above (other than those aspects which may operationally affect **Embedded Small Power Stations** or **Embedded Medium Power Stations**) to the relevant **Generators** and **Network Operators** and **Non-Embedded Customers**.
 - (v) Where a **Generator** with nuclear **Large Power Stations** which may be operationally affected by the preliminary **GB Transmission System** outage programme referred to in (i) above (acting as a reasonable operator) is concerned on grounds relating to safety about the effect which an outage within such outage programme might have on one or more of its nuclear **Large Power Stations**, it may contact **NGET** to explain its concerns and discuss whether there is an alternative way of taking that outage (having regard to technical feasibility). If there is such an alternative way, but **NGET** refuses to adopt that alternative way in taking that outage, that **Generator** may involve the **Disputes Resolution Procedure** to decide on the way the outage should be taken. If there is no such alternative way, then **NGET** may take the outage despite that **Generator's** concerns.
- (d) By 1600 hours each Monday, Tuesday, Wednesday and Thursday
- (i) **NGET** shall prepare a final **GB Transmission System** outage programme for the following day.
 - (ii) **NGET** shall notify each **Generator** and **Network Operator** and **Non-Embedded Customer** in writing of the factors set out in (a)(ii) above (other than those aspects which may operationally affect **Embedded Small Power Stations** or **Embedded Medium Power Stations**).

OC2.4.2 DATA REQUIREMENTS

OC2.4.2.1 When a **Statement of Readiness** under the **Bilateral Agreement** and/or **Construction Agreement** is submitted, and thereafter in calendar week 24 in each calendar year,

- (a) each **Generator** shall (subject to OC2.4.2.1(k)) in respect of each of its:-
- (i) **Gensets** (in the case of the **Generation Planning Parameters**); and
 - (ii) **CCGT Units** within each of its **CCGT Modules** at a **Large Power Station** (in the case of the **Generator Performance Chart**)
- submit to **NGET** in writing the **Generation Planning Parameters** and the **Generator Performance Chart**.
- (b) Each shall meet the requirements of CC.6.3.2 and shall reasonably reflect the true operating characteristics of the **Genset**.
- (c) They shall be applied (unless revised under this **OC2** or (in the case of the **Generator Performance Chart** only) **BC1** in relation to **Other Relevant Data**) from the **Completion Date**, in the case of the ones submitted with the **Statement of Readiness**, and in the case of the ones submitted in calendar week 24, from the beginning of week 25 onwards.
- (d) They shall be in the format indicated in Appendix 1 for these charts and as set out in Appendix 2 for the **Generation Planning Parameters**.
- (e) Any changes to the **Generator Performance Chart** or **Generation Planning Parameters** should be notified to **NGET** promptly.
- (f) **Generators** should note that amendments to the composition of the **CCGT Module** or **Power Park Module** at **Large Power Stations** may only be made in accordance with the principles set out in PC.A.3.2.3 or PC.A.3.2.4 respectively. If in accordance with PC.A.3.2.3 or PC.A.3.2.4 an amendment is made, any consequential changes to the **Generation Planning Parameters** should be notified to **NGET** promptly.
- (g) **The Generator Performance Chart** must be as described below and demonstrate the limitation on reactive capability of the **System** voltage at 3% above nominal. It must also include any limitations on output due to the prime mover (both maximum and minimum), **Generating Unit** step up transformer or **User System**.
- (i) For a **Synchronous Generating Unit** on a **Generating Unit** specific basis at the **Generating Unit** Stator Terminals. It must include details of the **Generating Unit** transformer parameters.
 - (ii) For a **Non-Synchronous Generating Unit** (excluding a **Power Park Unit**) on a **Generating Unit** specific basis at the **Grid Entry Point** (or **User System Entry Point** if **Embedded**).
 - (iii) For a **Power Park Module**, on a **Power Park Module** specific basis at the **Grid Entry Point** (or **User System Entry Point** if **Embedded**).
 - (iv) For a **DC Converter** on a **DC Converter** specific basis at the **Grid Entry Point** (or **User System Entry Point** if **Embedded**).

- (h) For each **CCGT Unit**, and any other **Generating Unit** or **Power Park Module** whose performance varies significantly with ambient temperature, the **Generator Performance Chart** shall show curves for at least two values of ambient temperature so that **NGET** can assess the variation in performance over all likely ambient temperatures by a process of linear interpolation or extrapolation. One of these curves shall be for the ambient temperature at which the **Generating Unit's** output, or **CCGT Module** at a **Large Power Station** output or **Power Park Module's** output, as appropriate, equals its **Registered Capacity**.
- (i) The **Generation Planning Parameters** supplied under OC2.4.2.1 shall be used by **NGET** for operational planning purposes only and not in connection with the operation of the **Balancing Mechanism** (subject as otherwise permitted in the **BCs**).
- (j) Each **Generator** shall in respect of each of its **CCGT Modules** at **Large Power Stations** submit to **NGET** in writing a **CCGT Module Planning Matrix**. It shall be prepared on a best estimate basis relating to how it is anticipated the **CCGT Module** will be running and which shall reasonably reflect the true operating characteristics of the **CCGT Module**. It will be applied (unless revised under this OC2) from the **Completion Date**, in the case of the one submitted with the **Statement of Readiness**, and in the case of the one submitted in calendar week 24, from the beginning of week 31 onwards. It must show the combination of **CCGT Units** which would be running in relation to any given MW output, in the format indicated in Appendix 3.

Any changes must be notified to **NGET** promptly. **Generators** should note that amendments to the composition of the **CCGT Module** at **Large Power Stations** may only be made in accordance with the principles set out in PC.A.3.2.3. If in accordance with PC.A.3.2.3 an amendment is made, an updated **CCGT Module Planning Matrix** must be immediately submitted to **NGET** in accordance with this OC2.4.2.1(b).

The **CCGT Module Planning Matrix** will be used by **NGET** for operational planning purposes only and not in connection with the operation of the **Balancing Mechanism**.

- (k) Each **Generator** shall in respect of each of its **Cascade Hydro Schemes** also submit the **Generation Planning Parameters** detailed at OC2.A.2.6 to OC2.A.2.10 for each **Cascade Hydro Scheme**. Such parameters need not also be submitted for the individual **Gensets** within such **Cascade Hydro Scheme**.
- (l) Each **Generator** shall in respect of each of its **Power Park Modules** at **Large Power Stations** submit to **NGET** in writing a **Power Park Module Planning Matrix**. It shall be prepared on a best estimate basis relating to how it is anticipated the **Power Park Module** will be running and which shall reasonably reflect the operating characteristics of the **Power Park Module**. It will be applied (unless revised under this OC2) from the **Completion Date**, in the case of the one submitted with the **Statement of Readiness**, and in the case of the one submitted in calendar week 24, from the beginning of week 31 onwards. It must show the number of each type of **Power Park Unit** in the **Power Park Module** typically expected to be available to generate, in the format indicated in Appendix 4. The **Power**

Park Module Planning Matrix shall be accompanied by a graph showing the variation in MW output with **Intermittent Power Source** (e.g. MW vs wind speed) for the **Power Park Module**. The graph shall indicate the typical value of the **Intermittent Power Source** for the **Power Park Module**.

Any changes must be notified to **NGET** promptly. **Generators** should note that amendments to the composition of the **Power Park Module** at **Large Power Stations** may only be made in accordance with the principles set out in PC.A.3.2.4. If in accordance with PC.A.3.2.4 an amendment is made, an updated **Power Park Module Planning Matrix** must be immediately submitted to **NGET** in accordance with this OC2.4.2.1(a).

The **Power Park Module Planning Matrix** will be used by **NGET** for operational planning purposes only and not in connection with the operation of the **Balancing Mechanism**.

OC2.4.2.2 Each **Network Operator** shall by 1000 hrs on the day falling seven days before each **Operational Day** inform **NGET** in writing of any changes to the circuit details called for in PC.A.2.2.1 which it is anticipated will apply on that **Operational Day** (under **BC1** revisions can be made to this data).

OC2.4.3 **NEGATIVE RESERVE ACTIVE POWER MARGINS**

OC2.4.3.1 In each calendar year, by the end of week 39 **NGET** will, taking into account the **Final Generation Outage Programme** and forecast of **Output Usable** supplied by each **Generator**, issue a notice in writing to:-

- (a) all **Generators** with **Large Power Stations** listing any period in which there is likely to be an unsatisfactory **System NRAPM**; and
- (b) all **Generators** with **Large Power Stations** which may, in **NGET's** reasonable opinion be affected, listing any period in which there is likely to be an unsatisfactory **Localised NRAPM**, together with the identity of the relevant **System Constraint Group** or **Groups**,

within the next calendar year, together with the margin. **NGET** and each **Generator** will take these into account in seeking to co-ordinate outages for that period.

OC2.4.3.2 (a) **By 0900 hours each Business Day**

Each **Generator** shall provide **NGET** in writing with a best estimate of **Genset** inflexibility on a daily basis for the period 2 to 14 days ahead (inclusive).

(b) **By 1600 hours each Wednesday**

Each **Generator** shall provide **NGET** in writing with a best estimate of **Genset** inflexibility on a weekly basis for the period 2 to 7 weeks ahead (inclusive).

(c) Between 1600 hours each Wednesday and 1200 hours each Friday

- (i) If **NGET**, taking into account the estimates supplied by **Generators** under (b) above, and forecast **Demand** for the period, foresees that:-
- (1) the level of the **System NRAPM** for any period within the period 2 to 7 weeks ahead (inclusive) is too low, it will issue a notice in writing to all **Generators** and **Network Operators** listing any periods and levels of **System NRAPM** within that period; and/or
 - (2) having also taken into account the appropriate limit on transfers to and from a **System Constraint Group**, the level of **Localised NRAPM** for any period within the period 2 to 7 weeks ahead (inclusive) is too low for a particular **System Constraint Group**, it will issue a notice in writing to all **Generators** and **Network Operators** which may, in **NGET's** reasonable opinion be affected by that **Localised NRAPM**, listing any periods and levels of **Localised NRAPM** within that period. A separate notice will be given in respect of each affected **System Constraint Group**.

Outages Adjustments

- (ii) **NGET** will then contact **Generators** in respect of their **Large Power Stations** to discuss outages as set out in the following paragraphs of this OC2.4.3.2.
- (iii) **NGET** will contact all **Generators** in the case of low **System NRAPM** and will contact **Generators** in relation to relevant **Large Power Stations** in the case of low **Localised NRAPM**. **NGET** will raise with each **Generator** the problems it is anticipating due to the low **System NRAPM** or **Localised NRAPM** and will discuss:-
- (1) whether any change is possible to the estimate of **Genset** inflexibility given under (b) above; and
 - (2) whether **Genset** outages can be taken to coincide with the periods of low **System NRAPM** or **Localised NRAPM** (as the case may be).

In relation to **Generators** with nuclear **Large Power Stations** the discussions on outages can include the issue of whether outages can be taken for re-fuelling purposes to coincide with the relevant low **System NRAPM** and/or **Localised NRAPM** periods.

- (iv) If agreement is reached with a **Generator** (which unlike the remainder of **OC2** will constitute a binding agreement), then such **Generator** will take such outage, as agreed with **NGET**, and **NGET** will issue a revised notice in writing to the **Generators** and **Network Operators** to which it sent notices under (i) above, reflecting the changes brought about to the periods and levels of **System NRAPM** and/or **Localised NRAPM** by the agreements with **Generators**.

(d) By 1600 hours each day

- (i) If **NGET**, taking into account the estimates supplied under (a) above, and forecast **Demand** for the period, foresees that:-
 - (1) the level of **System NRAPM** for any period within the period of 2 to 14 days ahead (inclusive) is too low, it will issue a notice in writing to all **Generators** and **Network Operators** listing the periods and levels of **System NRAPM** within those periods; and/or
 - (2) having also taken into account the appropriate limit on transfers to and from a **System Constraint Group**, the level of **Localised NRAPM** for any period within the period of 2 to 14 days ahead (inclusive) is too low for a particular **System Constraint Group**, it will issue a notice in writing to all **Generators** and **Network Operators** which may, in **NGET's** reasonable opinion be affected by that **Localised NRAPM**, listing any periods and levels of **Localised NRAPM** within that period. A separate notice will be given in respect of each affected **System Constraint Group**.
 - (ii) **NGET** will contact all **Generators** in respect of their **Large Power Stations** (or in the case of **Localised NRAPM**, all **Generators** which may, in **NGET's** reasonable opinion be affected, in respect of their relevant **Large Power Stations**) to discuss whether any change is possible to the estimate of **Genset** inflexibility given under (a) above and to consider **Large Power Station** outages to coincide with the periods of low **System NRAPM** and/or **Localised NRAPM** (as the case may be).
- (e) If on the day prior to a **Operational Day**, it is apparent from the **BM Unit Data** submitted by **Users** under **BC1** that **System NRAPM** and/or **Localised NRAPM** (as the case may be) is, in **NGET's** reasonable opinion, too low, then in accordance with the procedures and requirements set out in **BC1.5.5** **NGET** may contact **Users** to discuss whether changes to **Physical Notifications** are possible, and if they are, will reflect those in the operational plans for the next following **Operational Day** or will, in accordance with **BC2.9.4** instruct **Generators** to **De-Synchronise** a specified **Genset** for such period. In determining which **Genset** to so instruct, **BC2** provides that **NGET** will not (other than as referred to below) consider in such determination (and accordingly shall not instruct to **De-Synchronise**) any **Genset** within an **Existing Gas Cooled Reactor Plant**. **BC2** further provides that:-
- (i) **NGET** is permitted to instruct to **De-Synchronise** any **Gensets** within an **Existing AGR Plant** if those **Gensets** within an **Existing AGR Plant** have failed to offer to be flexible for the relevant instance at the request of **NGET** provided the request is within the **Existing AGR Plant Flexibility Limit**.
 - (ii) **NGET** will only instruct to **De-Synchronise** any **Gensets** within an **Existing Magnox Reactor Plant** or within an **Existing AGR Plant** (other than under (i) above) if the level of **System NRAPM** (taken together with **System** constraints) and/or **Localised NRAPM** is such that it is not possible to avoid **De-Synchronising** such **Generating Unit**, and provided the power flow across each **External**

Interconnection is either at zero or results in an export of power from the **Total System**. This proviso applies in all cases in the case of **System NRAPM** and in the case of **Localised NRAPM**, only when the power flow would have a relevant effect.

OC2.4.4 FREQUENCY SENSITIVE OPERATION

By 1600 hours each Wednesday

OC2.4.4.1 Using such information as **NGET** shall consider relevant including, if appropriate, forecast **Demand**, any estimates provided by **Generators** of **Genset** inflexibility and anticipated plant mix relating to operation in **Frequency Sensitive Mode**, **NGET** shall determine for the period 2 to 7 weeks ahead (inclusive) whether it is possible that there will be insufficient **Gensets** (other than those **Gensets** within **Existing Gas Cooled Reactor Plant** which are permitted to operate in **Limited Frequency Sensitive Mode** at all times under BC3.5.3) to operate in **Frequency Sensitive Mode** for all or any part of that period.

OC2.4.4.2 BC3.5.3 explains that **NGET** permits **Existing Gas Cooled Reactor Plant** other than **Frequency Sensitive AGR Units** to operate in a **Limited Frequency Sensitive Mode** at all times.

OC2.4.4.3 If **NGET** foresees that there will be an insufficiency in **Gensets** operating in a **Frequency Sensitive Mode**, it will contact **Generators** in order to seek to agree (as soon as reasonably practicable) that all or some of the **Gensets** (the MW amount being determined by **NGET** but the **Gensets** involved being determined by the **Generator**) will take outages to coincide with such period as **NGET** shall specify to enable replacement by other **Gensets** which can operate in a **Frequency Sensitive Mode**. If agreement is reached (which unlike the remainder of OC2 will constitute a binding agreement) then such **Generator** will take such outage as agreed with **NGET**. If agreement is not reached, then the provisions of BC2.9.5 may apply.

OC2.4.5 If in **NGET's** reasonable opinion it is necessary for both the procedure set out in OC2.4.3 (relating to **System NRAPM** and **Localised NRAPM**) and in OC2.4.4 (relating to operation in **Frequency Sensitive Mode**) to be followed in any given situation, the procedure set out in OC2.4.3 will be followed first, and then the procedure set out in OC2.4.4. For the avoidance of doubt, nothing in this paragraph shall prevent either procedure from being followed separately and independently of the other.

OC2.4.6 OPERATING MARGIN DATA REQUIREMENTS

OC2.4.6.1 Modifications to relay settings

'Relay settings' in this OC2.4.6.1 refers to the settings of **Low Frequency Relays** in respect of **Gensets** that are available for start from standby by **Low Frequency Relay** initiation with **Fast Start Capability** agreed pursuant to the **Bilateral Agreement**.

By 1600 hours each Wednesday

A change in relay settings will be sent by **NGET** no later than 1600 hours on a Wednesday to apply from 1000 hours on the Monday following. The settings allocated to particular **Large Power Stations** may be interchanged between 49.70Hz and 49.60Hz (or such other **System Frequencies** as **NGET** may have specified) provided the overall capacity at each setting and **System** requirements can, in **NGET's** view, be met.

Between 1600 hours each Wednesday and 1200 hours each Friday

If a **Generator** wishes to discuss or interchange settings it should contact **NGET** by 1200 hours on the Friday prior to the Monday on which it would like to institute the changes to seek **NGET's** agreement. If **NGET** agrees, **NGET** will then send confirmation of the agreed new settings.

By 1500 hours each Friday

If any alterations to relay settings have been agreed, then the updated version of the current relay settings will be sent to affected **Users** by 1500 hours on the Friday prior to the Monday on which the changes will take effect. Once accepted, each **Generator** (if that **Large Power Station** is not subject to forced outage or **Planned Outage**) will abide by the terms of its latest relay settings.

In addition, **NGET** will take account of any **Large Power Station** unavailability (as notified under OC2.4.1.2 submissions) in its total **Operating Reserve** policy.

NGET may from time to time, for confirmation purposes only, issue the latest version of the current relay settings to each affected **Generator**

OC2.4.6.2

Operating Margins

By 1600 hours each Wednesday

No later than 1600 hours on a Wednesday, **NGET** will provide an indication of the level of **Operating Reserve** to be utilised by **NGET** in connection with the operation of the **Balancing Mechanism** in the week beginning with the **Operational Day** commencing during the subsequent Monday, which level shall be purely indicative.

This **Operating Margin** indication will also note the possible level of **Operating Reserve** (if any) which may be provided by **Interconnector Users** in the week beginning with the **Operational Day** commencing during the subsequent Monday.

This **Operating Margin** indication will also note the possible level of **High Frequency Response** to be utilised by **NGET** in connection with the operation of the **Balancing Mechanism** in the week beginning with the **Operational Day** commencing during the subsequent Monday, which level shall be purely indicative.

OC2 APPENDIX 1

GENERATOR PERFORMANCE CHART

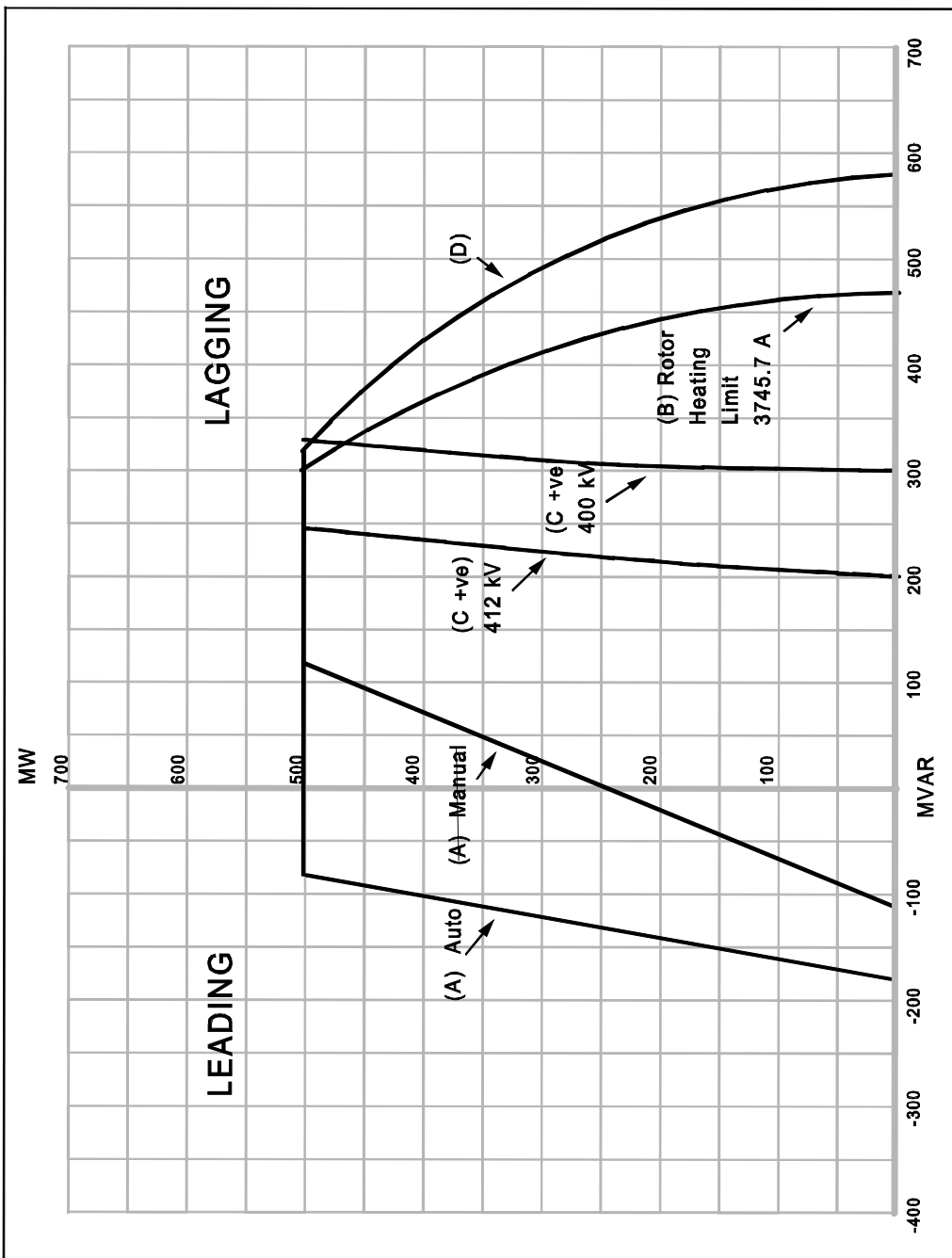

KEY	A) Practical Stability Limit B) Rotor Heating Limit C) Transformer Tap Limit D) Transformer MVA Limit
GENERATOR	MW 500 MVA 588 pf 0.85 kV 22 Xd 2.68
TRANSFORMER	MVA 570 Xt .147
UNIT TRANSFORMER	MW Load 15 MVAR Load 11.25
SYSTEM VOLTAGE	400 kV Nominal 412 kV High
File Ref : 76 :B	

Comments OPERATING CHART CONFIRMED BY LOADING TESTS

Generating Unit Stator Terminals

**POWER PARK MODULE PERFORMANCE CHART
AT THE CONNECTION POINT OR USER'S SYSTEM ENTRY POINT**

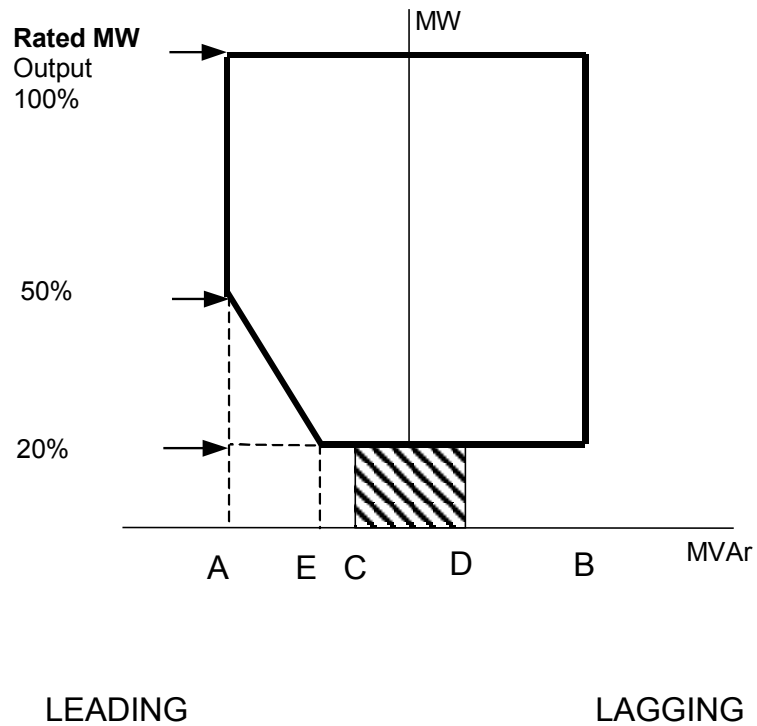

- Point A is equivalent (in MVar) to: 0.95 leading **Power Factor** at **Rated MW** output
- Point B is equivalent (in MVar) to: 0.95 lagging **Power Factor** at **Rated MW** output
- Point C is equivalent (in MVar) to: -5% of **Rated MW** output
- Point D is equivalent (in MVar) to: +5% of **Rated MW** output
- Point E is equivalent (in MVar) to: -12% of **Rated MW** output

OC2 APPENDIX 2

OC2.A.2 Generation Planning Parameters

The following parameters are required in respect of each **Genset**.

OC2.A.2.1 Regime Unavailability

Where applicable the following information must be recorded for each **Genset**.

- Earliest synchronising time:
Monday
Tuesday to Friday
Saturday to Sunday
- Latest de-synchronising time:
Monday to Thursday
Friday
Saturday to Sunday

OC2.A.2.2 Synchronising Intervals

- (a) The **Synchronising** interval between **Gensets** in a **Synchronising Group** assuming all **Gensets** have been **Shutdown** for 48 hours;
- (b) The **Synchronising Group** within the **Power Station** to which each **Genset** should be allocated.

OC2.A.2.3 De-Synchronising Interval

A fixed value **De-Synchronising** interval between **Gensets** within a **Synchronising Group**.

OC2.A.2.4 Synchronising Generation

The amount of MW produced at the moment of **Synchronising** assuming the **Genset** has been **Shutdown** for 48 hours.

OC2.A.2.5 Minimum Non-zero time (MNZT)

The minimum period on-load between **Synchronising** and **De-Synchronising** assuming the **Genset** has been **Shutdown** for 48 hours.

OC2.A.2.6 Run-Up rates

A run-up characteristic consisting of up to three stages from **Synchronising Generation** to **Output Usable** with up to two intervening break points assuming the **Genset** has been **Shutdown** for 48 hours.

OC2.A.2.7 Run-down rates

A run down characteristic consisting of up to three stages from **Output Usable** to **De-Synchronising** with breakpoints at up to two intermediate load levels.

OC2.A.2.8 Notice to Deviate from Zero (NDZ)

The period of time normally required to **Synchronise** a **Genset** following instruction from **NGET** assuming the **Genset** has been **Shutdown** for 48 hours.

OC2.A.2.9 Minimum Zero time (MZT)

The minimum interval between **De-Synchronising** and **Synchronising** a **Genset**.

OC2.A.2.10 Two Shifting Limit

The maximum number of times that a **Genset** may **De-Synchronise** per **Operational Day**.

OC2.A.2.11 Gas Turbine Units loading parameters

- Loading rate for fast starting
- Loading rate for slow starting

OC2 APPENDIX 3

CCGT Module Planning Matrix example form

CCGT MODULE	CCGT GENERATING UNITS AVAILABLE								
	1 st GT	2 nd GT	3 rd GT	4 th GT	5 th GT	6 th GT	1 st ST	2 nd ST	3 rd ST
OUTPUT USABLE	OUTPUT USABLE								
MW	150	150	150				100		
0MW to 150MW	/								
151MW to 250MW	/						/		
251MW to 300MW	/	/							
301MW to 400MW	/	/					/		
401MW to 450MW	/	/	/						
451MW to 550MW	/	/	/				/		

OC2 APPENDIX 4

Power Park Module Planning Matrix example form

POWER PARK UNITS AVAILABLE	POWER PARK UNITS			
	Type A	Type B	Type C	Type D
Description (Make / Model)				
Number of units				

The **Power Park Module Planning Matrix** may have as many columns as are required to provide information on the different make and model for each type of **Power Park Unit** in a **Power Park Module**. The description is required to assist identification of the **Power Park Units** within the **Power Park Module** and correlation with data provided under the **Planning Code**.

< End of OC2 >

ATTACHMENT TO OC2 – SYSTEM ZONAL BOUNDARIES



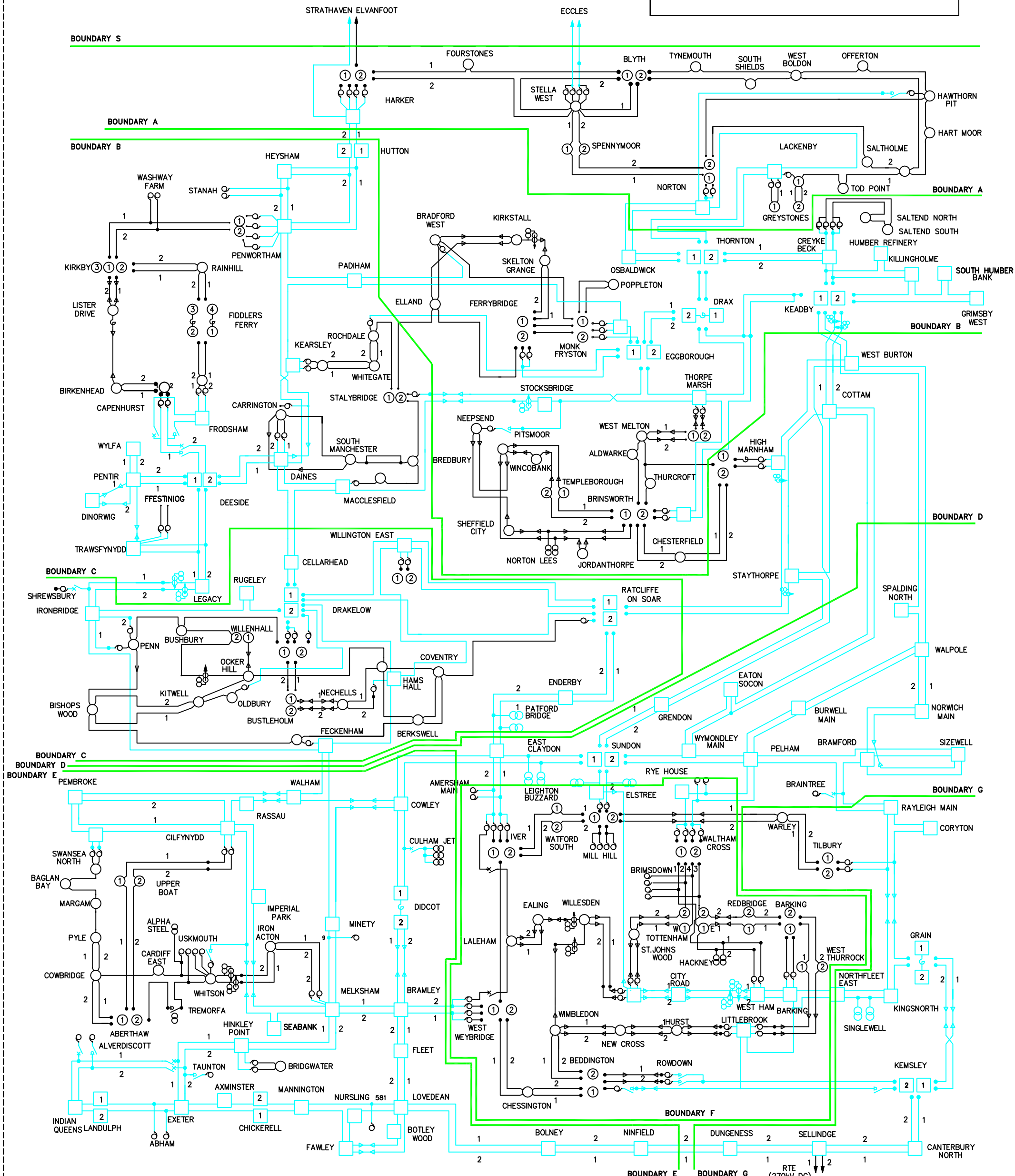
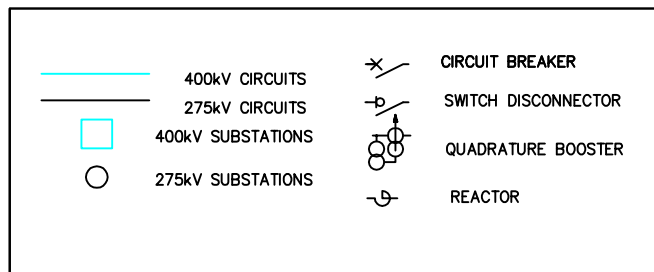

(This diagram does not form part of the Grid Code)



UNCONTROLLED COPY
NOT SUBJECT TO
REVISION SERVICING

ATTACHMENT TO OC2 – SYSTEM ZONAL BOUNDARIES– SCOTLAND

(This diagram does not form part of the Grid Code)

KEY	
	275kV CIRCUITS
	132kV CIRCUITS
	400kV SUBSTATIONS
	132kV SUBSTATIONS
	275kV SUBSTATIONS

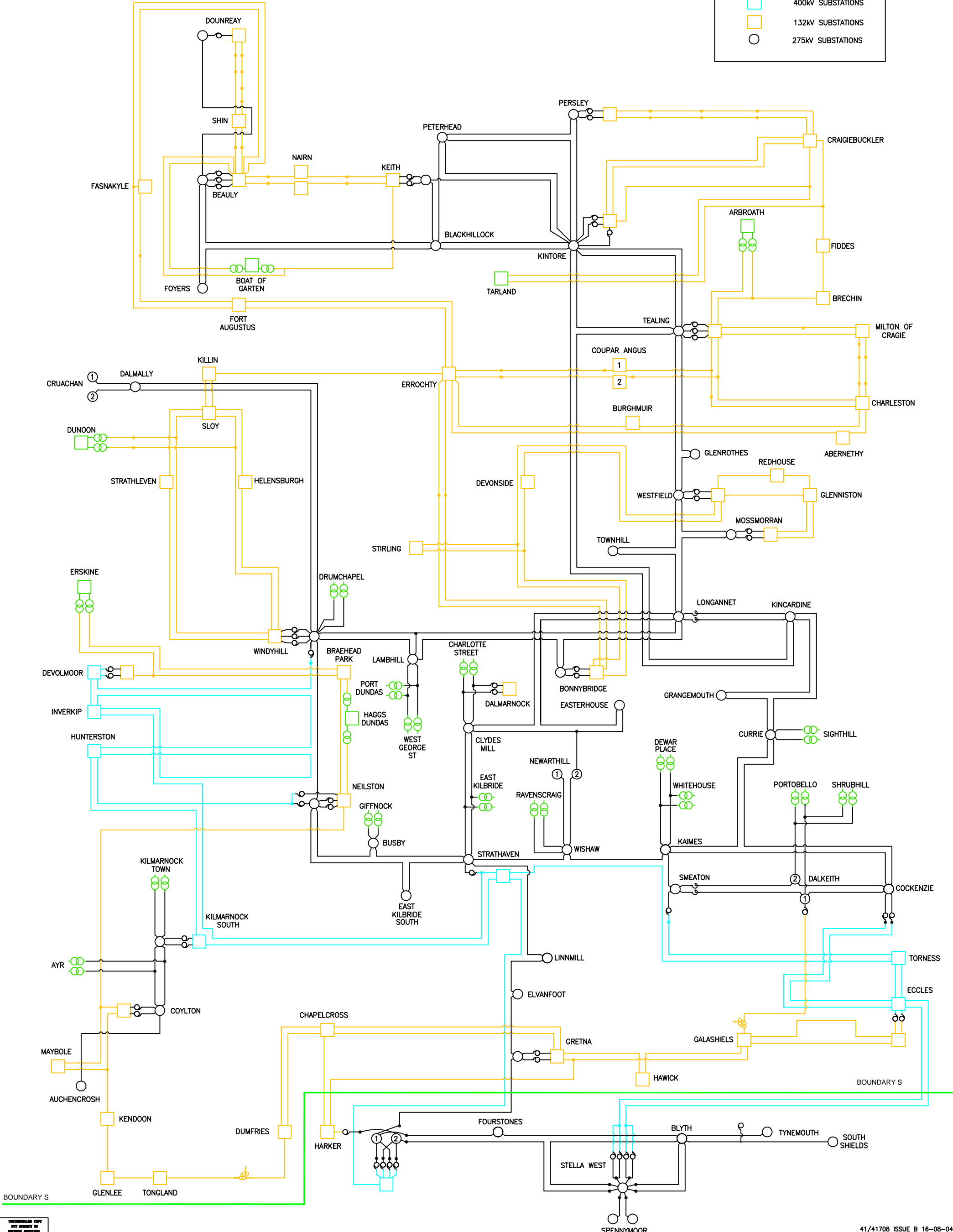

UNCONTROLLED COPY
NOT SUBJECT TO
ISSUANCE RESTRICTIONS

OPERATING CODE NO. 3

Not Used

(This contents page does not form part of the Grid Code)

OPERATING CODE NO. 4

Not Used

(This contents page does not form part of the Grid Code)

OPERATING CODE NO. 5

TESTING AND MONITORING

CONTENTS

(This contents page does not form part of the Grid Code)

<u>Paragraph No/Title</u>	<u>Page No</u>
OC5.1 INTRODUCTION.....	1
OC5.2 OBJECTIVE	2
OC5.3 SCOPE.....	2
OC5.4 MONITORING	3
OC5.4.1 Parameters to be monitored.....	3
OC5.4.2 Procedure for monitoring.....	3
OC5.5 PROCEDURE FOR TESTING.....	3
OC5.5.1 Request for Testing.....	3
OC5.5.2 Conduct of Test.....	5
OC5.5.3 Test Assessment	7
OC5.5.4 Test Failure/Re-test.....	12
OC5.5.5 Dispute following Re-test	12
OC5.6 DISPUTE RESOLUTION.....	12
OC5.7 BLACK START TESTING.....	13
OC5.7.1 General	13
OC5.7.2 Procedure for a Black Start Test	13
OC5.7.2.1 BS Unit Tests.....	13
OC5.7.2.2 BS Station Test.....	14
OC5.7.2.4 Failure of a Black Start Test.....	14

OPERATING CODE NO. 5

TESTING AND MONITORING

OC5.1 INTRODUCTION

Operating Code No. 5 ("OC5") specifies the procedures to be followed by **NGET** in carrying out:

- (a) monitoring
 - (i) of **BM Units** against their expected input or output;
 - (ii) of compliance by **Users** with the **CC** and in the case of response to **Frequency, BC3**; and
 - (iii) of the provision by **Users** of **Ancillary Services** which they are required or have agreed to provide; and
- (b) the following tests (which are subject to **System** conditions prevailing on the day):
 - (i) tests on **Gensets** and **DC Converters** to test that they have the capability to comply with the **CC** and, in the case of response to **Frequency, BC3** and to provide the **Ancillary Services** that they are either required or have agreed to provide;
 - (ii) tests on **BM Units**, to ensure that the **BM Units** are available in accordance with their submitted **Export and Import Limits, QPNs, Joint BM Unit Data** and **Dynamic Parameters**.

The **OC5** tests include the **Black Start Test** procedure.

In respect of a **Cascade Hydro Scheme** the provisions of **OC5** shall be applied as follows:

- (y) in respect of the **BM Unit** for the **Cascade Hydro Scheme** the parameters referred to at OC5.4.1 (a) and (c) in respect of **Commercial Ancillary Services** will be monitored and tested;
- (z) in respect of each **Genset** forming part of the **Cascade Hydro Scheme** the parameters referred to at OC5.4.1 (a), (b) and (c) will be tested and monitored. In respect of OC5.4.1 (a) the performance of the **Gensets** will be tested and monitored against their expected input or output derived from the data submitted under BC1.4.2(a)(2). Where necessary to give effect to the requirements for **Cascade Hydro Schemes** in the following provisions of **OC5** the term **Genset** will be read and construed in the place of **BM Unit**.

In respect of **Embedded Exemptable Large Power Stations** the provisions of **OC5** shall be applied as follows:

- (1) where there is a **BM Unit** registered in the **BSC** in respect of **Generating Units** the provisions of **OC5** shall apply as written;
- (2) in all other cases, in respect of each **Generating Unit** the parameters referred to at OC5.4.1(a), (b) and (c) will be tested and monitored. In respect of OC5.4.1(a) the performance of the **Generating Unit** will be tested and monitored against their expected input or output derived from the data submitted under BC1.4.2(a)(2). Where necessary to give effect to the requirements for such **Embedded Exemptable Large Power Stations** in the provisions of **OC5** the term **Generating Unit** will be read and construed in place of **BM Unit**.

OC5.2 OBJECTIVE

The objectives of **OC5** are to establish:

- (a) that **Users** comply with the **CC**;
- (b) whether **BM Units** operate in accordance with their expected input or output derived from their **Final Physical Notification Data** and agreed **Bid-Offer Acceptances** issued under **BC2**;
- (c) whether each **BM Unit** is available as declared in accordance with its submitted **Export and Import Limits, QPN, Joint BM Unit Data** and **Dynamic Parameters**; and
- (d) whether **Generators, DC Converter Station** owners and **Suppliers** can provide those **Ancillary Services** which they are either required or have agreed to provide.

In certain limited circumstances as specified in this **OC5** the output of **CCGT Units** may be verified, namely the monitoring of the provision of **Ancillary Services** and the testing of **Reactive Power** and automatic **Frequency Sensitive Operation**.

OC5.3 SCOPE

OC5 applies to **NGET** and to **Users**, which in **OC5** means:

- (a) **Generators**;
- (b) **Network Operators**;
- (c) **Non-Embedded Customers**;
- (d) **Suppliers**; and
- (e) **DC Converter Station** owners.

OC5.4 MONITORING

OC5.4.1 Parameters to be monitored

NGET will monitor the performance of:

- (a) **BM Units** against their expected input or output derived from their **Final Physical Notification Data** and agreed **Bid-Offer Acceptances** issued under **BC2**;
- (b) compliance by **Users** with the **CC**; and
- (c) the provision by **Users** of **Ancillary Services** which they are required or have agreed to provide.

OC5.4.2 Procedure for Monitoring

OC5.4.2.1 In the event that a **BM Unit** fails persistently, in **NGET's** reasonable view, to follow, in any material respect, its expected input or output or a **User** fails persistently to comply with the **CC** and in the case of response to **Frequency, BC3** or to provide the **Ancillary Services** it is required, or has agreed, to provide, **NGET** shall notify the relevant **User** giving details of the failure and of the monitoring that **NGET** has carried out.

OC5.4.2.2 The relevant **User** will, as soon as possible, provide **NGET** with an explanation of the reasons for the failure and details of the action that it proposes to take to:

- (a) enable the **BM Unit** to meet its expected input or output or to provide the **Ancillary Services** it is required or has agreed to provide, within a reasonable period, or
- (b) in the case of a **Generating Unit** (excluding a **Power Park Unit**), **CCGT Module, Power Park Module** or **DC Converter** to comply with the **CC** and in the case of response to **Frequency, BC3** or to provide the **Ancillary Services** it is required or has agreed to provide, within a reasonable period.

OC5.4.2.3 **NGET** and the **User** will then discuss the action the **User** proposes to take and will endeavour to reach agreement as to:

- (a) any short term operational measures necessary to protect other **Users**; and
- (b) the parameters which are to be submitted for the **BM Unit** and the effective date(s) for the application of the agreed parameters.

OC5.4.2.4 In the event that agreement cannot be reached within 10 days of notification of the failure by **NGET** to the **User**, **NGET** or the **User** shall be entitled to require a test, as set out in OC5.5 and OC5.6, to be carried out.

OC5.5 PROCEDURE FOR TESTING

OC5.5.1 Request For Testing

OC5.5.1.1 **NGET** may at any time (although not normally more than twice in any calendar year in respect of any particular **BM Unit**) issue an instruction requiring a **User** to carry out a test, provided **NGET** has reasonable grounds of justification based upon:

- (a) a submission of data, or a statement from a **User** indicating a change in plant or apparatus or settings (including but not limited to governor and excitation control systems) that may reasonably be expected to result in a material change of performance; or
- (b) monitoring carried out in accordance with OC5.4.2; or
- (c) notification from a **User** of completion of an agreed action from OC5.4.2.

OC5.5.1.2 The test, referred to in OC5.5.1.1 and carried out at a time no sooner than 48 hours from the time that the instruction was issued, on any one or more of the **User's BM Units** should only be to demonstrate that the relevant **BM Unit**:

- (a) if active in the **Balancing Mechanism**, meets the ability to operate in accordance with its submitted **Export and Import Limits, QPN, Joint BM Unit Data** and **Dynamic Parameters** and achieve its expected input or output which has been monitored under OC5.4; and
- (b) meets the requirements of the paragraphs in the **CC** which are applicable to such **BM Units**; and

in the case of a **BM Unit** comprising a **Generating Unit**, a **CCGT Module**, a **Power Park Module** or a **DC Converter** meets,

- (c) the requirements for operation in **Frequency Sensitive Mode** and compliance with the requirements for operation in **Limited Frequency Sensitive Mode** in accordance with CC.6.3.3, BC3.5.2 and BC3.7.2; or
- (d) the terms of the applicable **Supplemental Agreement** agreed with the **Generator** to have a **Fast Start Capability**; or
- (e) the **Reactive Power** capability registered with **NGET** under **OC2** which shall meet the requirements set out in CC.6.3.2. In the case of a test on a **Generating Unit** within a **CCGT Module** the instruction need not identify the particular **CCGT Unit** within the **CCGT Module** which is to be tested, but instead may specify that a test is to be carried out on one of the **CCGT Units** within the **CCGT Module**.

OC5.5.1.3 (a) The instruction referred to in OC5.5.1.1 may only be issued if the relevant **User** has submitted **Export and Import Limits** which notify that the relevant **BM Unit** is available in respect of the **Operational Day** current at the time at which the instruction is issued. The relevant **User** shall then be obliged to submit **Export and Import Limits** with a magnitude greater than zero for that **BM Unit** in respect of the time and the duration that the test is instructed to be carried out, unless that **BM Unit** would not then be available by reason of forced outage or **Planned Outage** expected prior to this instruction.

- (b) In the case of a **CCGT Module** the **Export and Import Limits** data must relate to the same **CCGT Units** which were included in respect of the **Operational Day** current at the time at which the instruction is issued and must include, in relation to each of the **CCGT Units** within the **CCGT Module**, details of the various data set out in BC1.A.1.3 and BC1.A.1.5, which parameters **NGET** will utilise in instructing in accordance with this OC5 in issuing **Bid-Offer Acceptances**. The parameters shall reasonably reflect the true operating characteristics of each **CCGT Unit**.

OC5.5.2 Conduct Of Test

OC5.5.2.1 The performance of the **BM Unit** will be recorded at **Transmission Control Centres** notified by **NGET** with monitoring at site when necessary, from voltage and current signals provided by the **User** for each **BM Unit** under CC.6.6.1.

OC5.5.2.2 If monitoring at site is undertaken, the performance of the **BM Unit** will be recorded on a suitable recorder (with measurements, in the case of a **Synchronous Generating Unit**, taken on the **Generating Unit** Stator Terminals / on the **LV** side of the generator transformer) or in the case of a **Non-Synchronous Generating Unit** (excluding **Power Park Units**), **Power Park Module** or **DC Converter** at the point of connection in the relevant **User's Control Room**, in the presence of a reasonable number of representatives appointed and authorised by **NGET**. If **NGET** or the **User** requests, monitoring at site will include measurement of the following parameters:

- (a) for Steam Turbines: governor pilot oil pressure, valve position and steam pressure; or
- (b) for Gas Turbines: Inlet Guide Vane position, Fuel Valve positions, Fuel Demand signal and Exhaust Gas temperature; or
- (c) for Hydro Turbines: Governor Demand signal, Actuator Output signal, Guide Vane position; and/or
- (d) for Excitation Systems: Generator Field Voltage and **Power System Stabiliser** signal where appropriate.
- (e) for **Power Park Modules**: appropriate signals related to the voltage/**Reactive Power/Power Factor** control system and the **Frequency** control system as agreed at the time of connection.
- (f) for **DC Converters**: appropriate signals related to the voltage/**Reactive Power/Power Factor** control system and the **Frequency** control system as agreed at the time of connection.

OC5.5.2.3 The test will be initiated by the issue of instructions, which may be accompanied by a **Bid-Offer Acceptance**, under **BC2** (in accordance with the **Export and Import Limits, QPN, Joint BM Unit Data** and **Dynamic Parameters** which have been submitted for the day on which the test was called, or in the case of a **CCGT Unit**, in accordance with the parameters submitted under OC5.5.1.3). The instructions in respect of a **CCGT Unit** within a **CCGT Module** will be in respect of the **CCGT Unit**, as provided in BC2.

OC5.5.2.4 The **User** is responsible for carrying out the test when requested by **NGET** in accordance with OC5.5.1 and retains the responsibility for the safety of personnel and plant during the test.

OC5.5.3 Test and Monitoring Assessment

The pass criteria must be read in conjunction with the full text under the Grid Code reference. The **BM Unit** will pass the test if the criteria below are met:

Parameter to be Tested	Grid Code Reference	Pass Criteria (to be read in conjunction with the full text under the Grid Code reference)
Harmonic Content	CC.6.1.5(a)	Measured harmonic emissions do not exceed the limits specified in the Bilateral Agreement or where no such limits are specified, the relevant planning level specified in G5/4.
Phase Unbalance	CC.6.1.5(b)	The measured maximum Phase (Voltage) Unbalance on the GB Transmission System should remain, in England and Wales, below 1% and, in Scotland, below 2%.
Phase Unbalance	CC.6.1.6	In England and Wales, measured infrequent short duration peaks in Phase (Voltage) Unbalance should not exceed the maximum value stated in the Bilateral Agreement .
Voltage Fluctuations	CC.6.1.7(a)	In England and Wales, measured voltage fluctuations at the Point of Common Coupling shall not exceed 1% of the voltage level for step changes. Measured voltage excursions other than step changes may be allowed up to a level of 3%. In Scotland, measured voltage fluctuations at a Point of Common Coupling shall not exceed the limits set out in Engineering Recommendation P28 .
Flicker	CC.6.1.7(b)	Measured voltage fluctuations at a Point of Common Coupling shall not exceed, for voltages above 132kV, Flicker Severity (Short Term) of 0.8 Unit and Flicker Severity (Long Term) of 0.6 Unit, and, for voltages at 132kV and below, shall not exceed Flicker Severity (Short Term) of 1.0 Unit and Flicker Severity (Long Term) of 0.8 Unit, as set out in Engineering Recommendation P28 as current at the Transfer Date .
Voltage Quality		

Parameter to be Tested	Grid Code Reference	Pass Criteria (to be read in conjunction with the full text under the Grid Code reference)
Fault Clearance Times	CC.6.2.2.2.2(a) CC.6.2.3.1.1(a)	The fault clearance times shall be in accordance with the Bilateral Agreement .
Back-Up Protection	CC.6.2.2.2.2(b) CC.6.2.3.1.1(b)	The Back-Up Protection system provided by Generators operates in the times specified in CC.6.2.2.2.2(b). The Back-Up Protection system provided by Network Operators and Non-Embedded Customers operates in the times specified in CC.6.2.3.1.1(b) and with Discrimination as specified in the Bilateral Agreement .
Circuit Breaker fail Protection	CC.6.2.2.2.2(c) CC.6.2.3.1.1(c)	The circuit breaker fail Protection shall initiate tripping so as to interrupt the fault current within 200ms.
Reactive Capability	CC.6.3.2 CC.6.3.4	The Generating Unit , DC Converter or Power Park Module will pass the test if it is within $\pm 5\%$ of the reactive capability registered with NGET under OC2 which shall meet the requirements set out in CC.6.3.2. The duration of the test will be for a period of up to 60 minutes during which period the System voltage at the Grid Entry Point for the relevant Generating Unit , DC Converter or Power Park Module will be maintained by the Generator at the voltage specified pursuant to BC2.8 by adjustment of Reactive Power on the remaining Generating Units , DC Converters or Power Park Modules , if necessary. Measurements of the Reactive Power output under steady state conditions should be consistent with Grid Code requirements i.e. fully available within the voltage range $\pm 5\%$ at 400kV, 275kV and 132kV and lower voltages.
Fault Clearance		
Reactive Capability		

Parameter to be Tested	Grid Code Reference	Pass Criteria (to be read in conjunction with the full text under the Grid Code reference)
Primary, Secondary and High Frequency Response		The measured response in MW/Hz is within $\pm 5\%$ of the level of response specified in the Ancillary Services Agreement for that Genset .
Stability with Voltage	CC.6.3.4	The measured Active Power output under steady state conditions of any Generating Unit , DC Converter or Power Park Module directly connected to the GB Transmission System should not be affected by voltage changes in the normal operating range.
Governor Standard	CC.6.3.7(a)	Measurements indicate that the Governor/ Frequency control system parameters are within the criteria set out in the appropriate governor/ Frequency control system standard (the version of which to apply being determined within CC.6.3.7).
Governor Stability	CC.6.3.7(b)	The measured Generating Unit , DC Converter or Power Park Module Active Power Output shall be stable over the entire operating range of the Generating Unit .
Governor Droop	CC.6.3.7(c)(ii)	The measured speed governor overall speed droop should be between 3% and 5%.
Governor Deadband	CC.6.3.7.(c)(iii)	Except for the Steam Unit within a CCGT Module , the measured speed governor/ Frequency control system deadband shall be no greater than 0.03Hz (for the avoidance of doubt, $\pm 0.015\text{Hz}$).
Target Frequency	CC.6.3.7(d)	Target Frequency settings over at least the range 50 ± 0.1 Hz shall be available.
Response Capability	CC.6.3.7(e) CC.A.3	The measured frequency response of each Generating Unit and/or CCGT Module which has a Completion Date after 1 January 2001 in England and Wales and after 1 April 2005 in Scotland shall meet requirement profile contained in Connection Conditions Appendix 3. Similarly for DC Converters with Completion Dates on or after 1 April 2005 and Power Park Modules using the GB Transmission System on or after 1 January 2006 (irrespective of its Completion Date excepting those in Scotland with Completion Date before 1 April 2005).
Limited High Frequency Response	BC3.7.2(b)	The measured response is within the requirements of BC3.7.2. i.e. the measured rate of change of Active Power output must be at least 2% of output per 0.1Hz deviation of System Frequency above 50.4Hz.
Output at reduced System Frequency	CC.6.3.3 BC3.5.1	For variations in System Frequency exceeding 0.1Hz within a period of less than 10 seconds, the Active Power output is within $\pm 0.2\%$ of the requirements of CC.6.3.3 when monitored at prevailing external air temperatures of up to 25°C.
Governor System Compliance		

Parameter to be Tested	Grid Code Reference	Pass Criteria (to be read in conjunction with the full text under the Grid Code reference)
Fast Start		The Fast Start Capability requirements of the Ancillary Services Agreement for that Genset are met.
Black Start	OC.5.7.1	The relevant Generating Unit or Power Park Module is Synchronised to the System within two hours of the Auxiliary Gas Turbine(s) or Auxiliary Diesel Engine(s) being required to start.
Excitation System/ Voltage Control	CC.6.3.8(a) (b) & BC2.11.2	Measurements of the continuously acting automatic excitation control system are required to demonstrate the provision of: (i) constant terminal voltage control; or (ii) zero MVAR transfer; or, (iii) voltage control with a Slope of the Generating Unit, DC Converter or Power Park Module as applicable without instability over the entire operating range of the Generating Unit, DC Converter or Power Park Module . The measured performance of the automatic excitation or voltage control system should also meet the requirements (including Power System Stabiliser performance) specified in the Bilateral Agreement .

Parameter to be Tested	Grid Code Reference	Pass Criteria
Export and Import Limits, QPN, Joint BM Unit Data and Dynamic Parameters	OC5	<p>The Export and Import Limits, QPN, Joint BM Unit Data and Dynamic Parameters under test are within 2½% of the declared value being tested.</p> <p>The duration of the test will be consistent with and sufficient to measure the relevant expected input or output derived from the Final Physical Notification Data and Bid-Offer Acceptances issued under BC2 which are still in dispute following the procedure in OC5.4.2.</p>
Synchronisation time	BC2.5.2.3	<p>Synchronisation takes place within ±5 minutes of the time it should have achieved Synchronisation.</p> <p>The duration of the test will be consistent with and sufficient to measure the relevant expected input or output derived from the Final Physical Notification Data and Bid-Offer Acceptances issued under BC2 which are still in dispute following the procedure in OC5.4.2.</p>
Run-up rates	OC5	<p>Achieves the instructed output and, where applicable, the first and/or second intermediate breakpoints, each within ±3 minutes of the time it should have reached such output and breakpoints from Synchronisation (or break point, as the case may be), calculated from the run-up rates in its Dynamic Parameters.</p> <p>The duration of the test will be consistent with and sufficient to measure the relevant expected input or output derived from the Final Physical Notification Data and Bid-Offer Acceptances issued under BC2 which are still in dispute following the procedure in OC5.4.2.</p>
Run-down rates	OC5	<p>Achieves the instructed output within ±5 minutes of the time, calculated from the run-down rates in its Dynamic Parameters.</p> <p>The duration of the test will be consistent with and sufficient to measure the relevant expected input or output derived from the Final Physical Notification Data and Bid-Offer Acceptances issued under BC2 which are still in dispute following the procedure in OC5.4.2.</p>
Dynamic Parameters		

Due account will be taken of any conditions on the **System** which may affect the results of the test. The relevant **User** must, if requested, demonstrate, to **NGET's** reasonable satisfaction, the reliability of the suitable recorders, disclosing calibration records to the extent appropriate.

OC5.5.4 Test Failure/Re-test

If the **BM Unit** concerned fails to pass the test the **User** must provide **NGET** with a written report specifying in reasonable detail the reasons for any failure of the test so far as they are then known to the **User** after due and careful enquiry. This must be provided within five **Business Days** of the test. If a dispute arises relating to the failure, **NGET** and the relevant **User** shall seek to resolve the dispute by discussion, and, if they fail to reach agreement, the **User** may by notice require **NGET** to carry out a re-test on 48 hours' notice which shall be carried out following the procedure set out in OC5.5.2 and OC5.5.3 and subject as provided in OC5.5.1.3, as if **NGET** had issued an instruction at the time of notice from the **User**.

OC5.5.5 Dispute following Re-test

If the **BM Unit** in **NGET's** view fails to pass the re-test and a dispute arises on that re-test, either party may use the **Disputes Resolution Procedure** for a ruling in relation to the dispute, which ruling shall be binding.

OC5.6 DISPUTE RESOLUTION

OC5.6.1 If following the procedure set out in OC5.5 it is accepted that the **BM Unit** has failed the test or re-test (as applicable), the **User** shall within 14 days, or such longer period as **NGET** may reasonably agree, following such failure, submit in writing to **NGET** for approval the date and time by which the **User** shall have brought the **BM Unit** concerned to a condition where it complies with the relevant requirement. **NGET** will not unreasonably withhold or delay its approval of the **User's** proposed date and time submitted. Should **NGET** not approve the **User's** proposed date or time (or any revised proposal), the **User** should amend such proposal having regard to any comments **NGET** may have made and re-submit it for approval.

OC5.6.2 If a **BM Unit** fails the test, the **User** shall submit revised **Export and Import Limits, QPN, Joint BM Unit Data** and/or **Dynamic Parameters**, or in the case of a **BM Unit** comprising a **Generating Unit, CCGT Module, DC Converter** or **Power Park Module**, the **User** may amend, with **NGET's** approval, the relevant registered parameters of that **Generating Unit, CCGT Module, DC Converter** or **Power Park Module**, as the case may be, relating to the criteria, for the period of time until the **BM Unit** can achieve the parameters previously registered, as demonstrated in a re-test.

OC5.6.3 Once the **User** has indicated to **NGET** the date and time that the **BM Unit** can achieve the parameters previously registered or submitted, **NGET** shall either accept this information or require the **User** to demonstrate the restoration of the capability by means of a repetition of the test referred to in OC5.5.2 by an instruction requiring the **User** on 48 hours notice to carry out such a test. The provisions of this OC5.6 will apply to such further test.

OC5.7 **BLACK START TESTING**

OC.5.7.1 **General**

- (a) **NGET** may require a **Generator** with a **Black Start Station** to carry out a test (a "**Black Start Test**") on a **Genset** in a **Black Start Station** either while the **Black Start Station** remains connected to an external alternating current electrical supply (a "**BS Unit Test**") or while the **Black Start Station** is disconnected from all external alternating current electrical supplies (a "**BS Station Test**"), in order to demonstrate that a **Black Start Station** has a **Black Start Capability**.
- (b) Where **NGET** requires a **Generator** with a **Black Start Station** to carry out a **BS Unit Test**, **NGET** shall not require the **Black Start Test** to be carried out on more than one **Genset** at that **Black Start Station** at the same time, and would not, in the absence of exceptional circumstances, expect any of the other **Genset** at the **Black Start Station** to be directly affected by the **BS Unit Test**.
- (c) **NGET** may require a **Generator** with a **Black Start Station** to carry out a **BS Unit Test** at any time (but will not require a **BS Unit Test** to be carried out more than once in each calendar year in respect of any particular **Genset** unless it can justify on reasonable grounds the necessity for further tests or unless the further test is a re-test, and will not require a **BS Station Test** to be carried out more than once in every two calendar years in respect of any particular **Genset** unless it can justify on reasonable grounds the necessity for further tests or unless the further test is a re-test).
- (d) When **NGET** wishes a **Generator** with a **Black Start Station** to carry out a **Black Start Test**, it shall notify the relevant **Generator** at least 7 days prior to the time of the **Black Start Test** with details of the proposed **Black Start Test**.

OC.5.7.2 **Procedure for a Black Start Test**

The following procedure will, so far as practicable, be carried out in the following sequence for **Black Start Tests**:

OC.5.7.2.1 **BS Unit Tests**

- (a) The relevant **Generating Unit** shall be **Synchronised** and **Loaded**;
- (b) All the **Auxiliary Gas Turbines** and/or **Auxiliary Diesel Engines** in the **Black Start Station** in which that **Generating Unit** is situated, shall be **Shutdown**.
- (c) The **Generating Unit** shall be **De-Loaded** and **De-Synchronised** and all alternating current electrical supplies to its **Auxiliaries** shall be disconnected.
- (d) The **Auxiliary Gas Turbine(s)** or **Auxiliary Diesel Engine(s)** to the relevant **Generating Unit** shall be started, and shall re-energise the **Unit Board** of the relevant **Generating Unit**.

- (e) The **Auxiliaries** of the relevant **Generating Unit** shall be fed by the **Auxiliary Gas Turbine(s)** or **Auxiliary Diesel Engine(s)**, via the **Unit Board**, to enable the relevant **Generating Unit** to return to **Synchronous Speed**.
- (f) The relevant **Generating Unit** shall be **Synchronised** to the **System** but not **Loaded**, unless the appropriate instruction has been given by **NGET** under **BC2**.

OC.5.7.2.2 **BS Station Test**

- (a) All **Generating Units** at the **Black Start Station**, other than the **Generating Unit** on which the **Black Start Test** is to be carried out, and all the **Auxiliary Gas Turbines** and/or **Auxiliary Diesel Engines** at the **Black Start Station**, shall be **Shutdown**.
- (b) The relevant **Generating Unit** shall be **Synchronised** and **Loaded**.
- (c) The relevant **Generating Unit** shall be **De-Loaded** and **De-Synchronised**.
- (d) All external alternating current electrical supplies to the **Unit Board** of the relevant **Generating Unit**, and to the **Station Board** of the relevant **Black Start Station**, shall be disconnected.
- (e) An **Auxiliary Gas Turbine** or **Auxiliary Diesel Engine** at the **Black Start Station** shall be started, and shall re-energise either directly, or via the **Station Board**, the **Unit Board** of the relevant **Generating Unit**.
- (f) The provisions of OC.5.7.2.1 (e) and (f) shall thereafter be followed.

OC.5.7.2.3 All **Black Start Tests** shall be carried out at the time specified by **NGET** in the notice given under OC5.7.1(d) and shall be undertaken in the presence of a reasonable number of representatives appointed and authorised by **NGET**, who shall be given access to all information relevant to the **Black Start Test**.

OC.5.7.2.4 **Failure of a Black Start Test**

A **Black Start Station** shall fail a **Black Start Test** if the **Black Start Test** shows that it does not have a **Black Start Capability** (ie. if the relevant **Generating Unit** fails to be **Synchronised** to the **System** within two hours of the **Auxiliary Gas Turbine(s)** or **Auxiliary Diesel Engine(s)** being required to start).

OC.5.7.2.5 If a **Black Start Station** fails to pass a **Black Start Test** the **Generator** must provide **NGET** with a written report specifying in reasonable detail the reasons for any failure of the test so far as they are then known to the **Generator** after due and careful enquiry. This must be provided within five **Business Days** of the test. If a dispute arises relating to the failure, **NGET** and the relevant **Generator** shall seek to resolve the dispute by discussion, and if they fail to reach agreement, the **Generator** may require **NGET** to carry out a further **Black Start Test** on 48 hours notice which shall be carried out following the

procedure set out in OC.5.7.2.1 or OC.5.7.2.2 as the case may be, as if **NGET** had issued an instruction at the time of notice from the **Generator**.

OC.5.7.2.6 If the **Black Start Station** concerned fails to pass the re-test and a dispute arises on that re-test, either party may use the **Disputes Resolution Procedure** for a ruling in relation to the dispute, which ruling shall be binding.

OC.5.7.2.7 If following the procedure in OC.5.7.2.5 and OC.5.7.2.6 it is accepted that the **Black Start Station** has failed the **Black Start Test** (or a re-test carried out under OC.5.7.2.5), within 14 days, or such longer period as **NGET** may reasonably agree, following such failure, the relevant **Generator** shall submit to **NGET** in writing for approval, the date and time by which that **Generator** shall have brought that **Black Start Station** to a condition where it has a **Black Start Capability** and would pass the **Black Start Test**, and **NGET** will not unreasonably withhold or delay its approval of the **Generator's** proposed date and time submitted. Should **NGET** not approve the **Generator's** proposed date and time (or any revised proposal) the **Generator** shall revise such proposal having regard to any comments **NGET** may have made and resubmit it for approval.

OC.5.7.2.8 Once the **Generator** has indicated to **NGET** that the **Generating Station** has a **Black Start Capability**, **NGET** shall either accept this information or require the **Generator** to demonstrate that the relevant **Black Start Station** has its **Black Start Capability** restored, by means of a repetition of the **Black Start Test** referred to in OC5.7.1(d) following the same procedure as for the initial **Black Start Test**. The provisions of this OC.5.7.2 will apply to such test.

<End of OC5>

OPERATING CODE NO.6

DEMAND CONTROL

CONTENTS

(This contents page does not form part of the Grid Code)

<u>Paragraph No/Title</u>	<u>Page Number</u>
OC6.1 INTRODUCTION	1
OC6.2 OBJECTIVE	2
OC6.3 SCOPE.....	2
OC6.4 PROCEDURE FOR THE NOTIFICATION OF DEMAND CONTROL INITIATED BY NETWORK OPERATORS.....	3
OC6.5 PROCEDURE FOR THE IMPLEMENTATION OF DEMAND CONTROL ON THE INSTRUCTIONS OF NGET	4
OC6.6 AUTOMATIC LOW FREQUENCY DEMAND DISCONNECTION	7
OC6.7 EMERGENCY MANUAL DISCONNECTION	8
OC6.8 OPERATION OF THE BALANCING MECHANISM DURING DEMAND CONTROL	9
APPENDIX – SUMMARY SHEET	10

OPERATING CODE NO.6

DEMAND CONTROL

OC6.1 INTRODUCTION

OC6.1.1 **Operating Code No.6 ("OC6")** is concerned with the provisions to be made by **Network Operators**, and in relation to **Non-Embedded Customers** by **NGET**, to permit the reduction of **Demand** in the event of insufficient **Active Power** generation being available to meet **Demand**, or in the event of breakdown or operating problems (such as in respect of **System Frequency**, **System** voltage levels or **System** thermal overloads) on any part of the **GB Transmission System**.

OC6.1.2 **OC6** deals with the following:

- (a) **Customer** voltage reduction initiated by **Network Operators** (other than following the instruction of **NGET**);
- (b) **Customer Demand** reduction by **Disconnection** initiated by **Network Operators** (other than following the instruction of **NGET**);
- (c) **Demand** reduction instructed by **NGET**;
- (d) automatic low frequency **Demand Disconnection**; and
- (e) emergency manual **Demand Disconnection**.

The term "**Demand Control**" is used to describe any or all of these methods of achieving a **Demand** reduction.

OC6.1.3 The procedure set out in **OC6** includes a system of warnings to give advance notice of **Demand Control** that may be required by **NGET** under this **OC6**.

OC6.1.4 Data relating to **Demand Control** should include details relating to MW

OC6.1.5 The Electricity Supply Emergency Code issued by the Department of Trade and Industry, Energy Utilities Directorate, on 30 November 1999 provides that in certain circumstances consumers are given a certain degree of "protection" when rota disconnections are implemented pursuant to a direction under the Energy Act 1976. No such protection can be given in relation to **Demand Control** under the **Grid Code**.

OC6.1.6 Connections between **Large Power Stations** and the **GB Transmission System** and between such **Power Stations** and a **User System** will not, as far as possible, be disconnected by **NGET** pursuant to the provisions of **OC6** insofar as that would interrupt supplies

- (a) for the purposes of operation of the **Power Station** (including **Start-Up** and shutting down);
- (b) for the purposes of keeping the **Power Station** in a state such that it could be Started-up when it is off-**Load** for ordinary operational reasons; or
- (c) for the purposes of compliance with the requirements of a Nuclear Site Licence.

Demand Control pursuant to this **OC6** therefore applies subject to this exception.

OC6.2 OBJECTIVE

OC6.2.1 The overall objective of **OC6** is to require the provision of facilities to enable **NGET** to achieve reduction in **Demand** that will either avoid or relieve operating problems on the **GB Transmission System**, in whole or in part, and thereby to enable **NGET** to instruct **Demand Control** in a manner that does not unduly discriminate against, or unduly prefer, any one or any group of **Suppliers** or **Network Operators** or **Non-Embedded Customers**. It is also to ensure that **NGET** is notified of any **Demand Control** utilised by **Users** other than following an instruction from **NGET**.

OC6.2.2 For certain **Grid Supply Points** in Scotland it is recognised that it may not be possible to meet the requirements in OC6.4.5(b), OC6.5.3(b) (in respect of **Demand Disconnection** only), OC6.5.6 (ii), OC6.6.2 (c) and OC6.7.2 (b). In these circumstances **NGET** and the relevant **Network Operator(s)** will agree equivalent requirements covering a number of **Grid Supply Points**. If **NGET** and the relevant **Network Operator** fail to agree equivalent requirements covering a number of **Grid Supply Points**, then the relevant **Network Operator** will apply the provisions of OC6.4.5(b), OC6.5.3(b) (in respect of **Demand Disconnection** only), OC6.5.6(ii), OC6.6.2(c) and OC6.7.2(b) as evenly as reasonably practicable over the relevant **Network Operator's** entire **System**.

OC6.3 SCOPE

OC6.3.1 **OC6** applies to **NGET** and to **Users** which in **OC6** means:-

- (a) **Generators**; and
- (b) **Network Operators**.

It also applies to **NGET** in relation to **Non-Embedded Customers**.

OC6.3.2 Explanation

OC6.3.2.1 (a) Although OC6 does not apply to **Suppliers**, the implementation of **Demand Control** may affect their **Customers**.

(b) In all situations envisaged in **OC6**, **Demand Control** is exercisable:-

- (i) by reference to a **Network Operator's System**; or
- (ii) by **NGET** in relation to **Non-Embedded Customers**.

(c) **Demand Control** in all situations relates to the physical organisation of the **Total System**, and not to any contractual arrangements that may exist.

OC6.3.2.2 (a) Accordingly, **Demand Control** will be exercisable with reference to, for example, five per cent (or such other figure as may be utilised under OC6.5) tranches of **Demand** by a **Network Operator**.

(b) For a **Supplier**, whose **Customers** may be spread throughout a number of **User Systems** (and the **GB Transmission System**), to split its **Customers**

into five per cent (or such other figure as may be utilised under OC6.5) tranches of **Demand** would not result in **Demand Control** being implemented effectively on the **Total System**.

(c) Where **Demand Control** is needed in a particular area, **NGET** would not know which **Supplier** to contact and (even if it were to) the resulting **Demand Control** implemented, because of the diversity of contracts, may well not produce the required result.

OC6.3.2.3 (a) **Suppliers** should note, however, that, although implementation of **Demand Control** in respect of their **Customers** is not exercisable by them, their **Customers** may be affected by **Demand Control**.

(b) This will be implemented by **Network Operators** where the **Customers** are within **User Systems** directly connected to the **GB Transmission System** and by **NGET** where they are **Non-Embedded Customers**.

(c) The contractual arrangements relating to **Customers** being supplied by **Suppliers** will, accordingly, need to reflect this.

(d) The existence of a commercial arrangement for the provision of **Customer Demand Management** or **Commercial Ancillary Services** does not relieve a **Network Operator** from the **Demand Control** provisions of OC6.5, OC6.6 and OC6.7, which may be exercised from time to time.

OC6.4 PROCEDURE FOR THE NOTIFICATION OF DEMAND CONTROL INITIATED BY NETWORK OPERATORS (OTHER THAN FOLLOWING THE INSTRUCTION OF NGET)

OC6.4.1 Pursuant to the provisions of **OC1**, in respect of the time periods prior to 1100 hours each day, each **Network Operator** will notify **NGET** of all **Customer** voltage reductions and/or restorations and **Demand Disconnection** or reconnection, on a **Grid Supply Point** and half-hourly basis, which will or may, either alone or when aggregated with any other **Demand Control** planned by that **Network Operator**, result in a **Demand** change equal to or greater than the **Demand Control Notification Level** averaged over any half hour on any **Grid Supply Point**, which is planned to be instructed by the **Network Operator** other than following an instruction from **NGET** relating to **Demand** reduction.

OC6.4.2 Under **OC6**, each **Network Operator** will notify **NGET** in writing by 1100 hours each day (or such other time specified by **NGET** from time to time) for the next day (except that it will be for the next 3 days on Fridays and 2 days on Saturdays and may be longer (as specified by **NGET** at least one week in advance) to cover holiday periods) of **Customer** voltage reduction or **Demand Disconnection** which will or may result in a **Demand** change equal to or greater than the **Demand Control Notification Level** averaged over any half hour on any **Grid Supply Point**, (or which when aggregated with any other **Demand Control** planned by that **Network Operator** is equal to or greater than the **Demand Control Notification Level**), planned to take place during the next **Operational Day**.

OC6.4.3 When the **Customer** voltage reduction or **Demand Disconnection** which may result in a **Demand** change equal to or greater than the **Demand Control Notification Level** averaged over any half hour on any **Grid Supply Point** (or which when

aggregated with any other **Demand Control** planned or implemented by that **Network Operator** is equal to or greater than the **Demand Control Notification Level**) is planned after 1100 hours, each **Network Operator** must notify **NGET** as soon as possible after the decision to implement has been made. If the **Customer** voltage reduction or **Demand Disconnection** is implemented immediately after the decision to implement is made, each **Network Operator** must notify **NGET** within five minutes of implementation.

OC6.4.4 Where, after **NGET** has been notified, whether pursuant to **OC1**, OC6.4.2 or OC6.4.3, the planned **Customer** voltage reduction or **Demand Disconnection** is changed, the **Network Operator** will notify **NGET** as soon as possible of the new plans, or if the **Customer** voltage reduction or **Demand Disconnection** implemented is different to that notified, the **Network Operator** will notify **NGET** of what took place within five minutes of implementation.

OC6.4.5 Any notification under OC6.4.2, OC6.4.3 or OC6.4.4 will contain the following information on a **Grid Supply Point** and half hourly basis:

(a) the proposed (in the case of prior notification) and actual (in the case of subsequent notification) date, time and duration of implementation of the **Customer** voltage reduction or **Demand Disconnection**; and

(b) the proposed reduction in **Demand** by use of the **Customer** voltage reduction or **Demand Disconnection**.

OC6.4.6 Pursuant to the provisions of OC1.5.6, each **Network Operator** will supply to **NGET** details of the amount of **Demand** reduction actually achieved by use of the **Customer** voltage reduction or **Demand Disconnection**.

OC6.5 PROCEDURE FOR THE IMPLEMENTATION OF **DEMAND CONTROL** ON THE INSTRUCTIONS OF **NGET**

OC6.5.1 A **GB Transmission System Warning - High Risk of Demand Reduction** will, where possible, be issued by **NGET**, as more particularly set out in OC6.5.4, OC7.4.8 and BC1.5.4 when **NGET** anticipates that it will or may instruct a **Network Operator** to implement **Demand** reduction. It will, as provided in OC6.5.10 and OC7.4.8.2, also be issued to **Non-Embedded Customers**.

OC6.5.2 Where **NGET** expects to instruct **Demand** reduction within the following 30 minutes, **NGET** will where possible, issue a **GB Transmission System Warning - Demand Control Imminent** in accordance with OC7.4.8.2(c) and OC7.4.8.6.

OC6.5.3 (a) Whether a **GB Transmission System Warning - High Risk of Demand Reduction** or **GB Transmission System Warning - Demand Control Imminent** has been issued or not:-

(i) provided the instruction relates to not more than 20 per cent of its total **Demand** (measured at the time the **Demand** reduction is required); and

(ii) if less than that, is in four integral multiples of between four and six per cent,

each **Network Operator** will abide by the instructions of **NGET** with regard to **Demand** reduction under OC6.5 without delay.

- (b) The **Demand** reduction must be achieved within the **Network Operator's System** as far as possible uniformly across all **Grid Supply Points** (unless otherwise specified in the **GB Transmission System Warning - High Risk of Demand Reduction**) either by **Customer** voltage reduction or by **Demand Disconnection**, as soon as possible but in any event no longer than five minutes from the instruction being given by **NGET**.
- (c) Each **Network Operator** must notify **NGET** in writing by calendar week 24 each year of the integral multiples it will use with effect from the succeeding **Financial Year** onwards. Thereafter, any changes must be notified in writing to **NGET** at least 10 **Business Days** prior to the change coming into effect.

OC6.5.4 (a) Where **NGET** wishes to instruct a **Demand** reduction of more than 20 per cent of a **Network Operator's Demand** (measured at the time the **Demand** reduction is required), it shall, if it is able, issue a **GB Transmission System Warning - High Risk of Demand Reduction** to the **Network Operator** by 1600 hours on the previous day. The warning will state the percentage level of **Demand** reduction that **NGET** may want to instruct (measured at the time the **Demand** reduction is required).

(b) The **GB Transmission System Warning - High Risk of Demand Reduction** will specify the percentage of **Demand** reduction that **NGET** may require in integral multiples of the percentage levels notified by **Users** under OC6.5.3(c) up to (and including) 20 per cent and of five per cent above 20 per cent and will not relate to more than 40 per cent of **Demand** (measured at the time the **Demand** reduction is required) of the **Demand** on the **User System** of a **Network Operator**.

(c) If **NGET** has issued the **GB Transmission System Warning - High Risk of Demand Reduction** by 1600 hours on the previous day, on receipt of it the relevant **Network Operator** shall make available the percentage reduction in **Demand** specified for use within the period of the **GB Transmission System Warning**.

(d) If **NGET** has not issued the **GB Transmission System Warning - High Risk of Demand Reduction** by 1600 hours the previous day, but after that time, the **Network Operator** shall make available as much of the required **Demand** reduction as it is able, for use within the period of the **GB Transmission System Warning**.

OC6.5.5 (a) If **NGET** has given a **GB Transmission System Warning - High Risk of Demand Reduction** to a **Network Operator**, and has issued it by 1600 hours on the previous day, it can instruct the **Network Operator** to reduce its **Demand** by the percentage specified in the **GB Transmission System Warning**.

- (b) **NGET** accepts that if it has not issued the **GB Transmission System Warning - High Risk of Demand Reduction** by 1600 hours on the previous day or if it has issued it by 1600 hours on the previous day, but it requires a further percentage of **Demand** reduction (which may be in excess of 40 per cent of the total **Demand** on the **User System** of the **Network Operator** (measured at the time the **Demand** reduction is required) from that set out in the **GB Transmission System Warning**, it can only receive an amount that can be made available at that time by the **Network Operator**.
- (c) Other than with regard to the proviso, the provisions of OC6.5.3 shall apply to those instructions.

OC6.5.6 Once a **Demand** reduction has been applied by a **Network Operator** at the instruction of **NGET**, the **Network Operator** may interchange the **Customers** to whom the **Demand** reduction has been applied provided that,

- (i) the percentage of **Demand** reduction at all times within the **Network Operator's System** does not change; and
- (ii) at all times it is achieved within the **Network Operator's System** as far as possible uniformly across all **Grid Supply Points** (unless otherwise specified in the **GB Transmission System Warning - High Risk of Demand Reduction** if one has been issued),

until **NGET** instructs that **Network Operator** in accordance with **OC6**.

OC6.5.7 Each **Network Operator** will abide by the instructions of **NGET** with regard to the restoration of **Demand** under OC6.5 without delay. It shall not restore **Demand** until it has received such instruction. The restoration of **Demand** must be achieved as soon as possible and the process of restoration must begin within 2 minutes of the instruction being given by **NGET**.

OC6.5.8 In circumstances of protracted shortage of generation or where a statutory instruction has been given (eg. a fuel security period) and when a reduction in **Demand** is envisaged by **NGET** to be prolonged, **NGET** will notify the **Network Operator** of the expected duration.

OC6.5.9 The **Network Operator** will notify **NGET** in writing that it has complied with **NGET's** instruction under OC6.5, within five minutes of so doing, together with an estimation of the **Demand** reduction or restoration achieved, as the case may be.

OC6.5.10 **NGET** may itself implement **Demand** reduction and subsequent restoration on **Non-Embedded Customers** as part of a **Demand Control** requirement and it will organise the **GB Transmission System** so that it will be able to reduce **Demand** by **Disconnection** of, or **Customer** voltage reduction to, all or any **Non-Embedded Customers**. Equivalent provisions to those in OC6.5.4 shall apply to issuing a **GB Transmission System Warning - High Risk of Demand Reduction** to **Non-Embedded Customers**, as envisaged in OC7.4.8.

OC6.5.11 Pursuant to the provisions of OC1.5.6, the **Network Operator** will supply to **NGET** details of the amount of **Demand** reduction or restoration actually achieved.

OC6.6 AUTOMATIC LOW FREQUENCY DEMAND DISCONNECTION

OC6.6.1 Each **Network Operator** will make arrangements that will enable automatic low **Frequency Disconnection** of at least, in England and Wales, 60 per cent, and in Scotland, 40 per cent, of its total peak **Demand** (based on **Annual ACS Conditions**), in order to seek to limit the consequences of a major loss of generation or an **Event** on the **Total System** which leaves part of the **Total System** with a generation deficit.

OC6.6.2 (a) The **Demand** of each **Network Operator** which is subject to automatic low **Frequency Disconnection** will be split into discrete MW blocks.

(b) The number, location, size and the associated low **Frequency** settings of these blocks, will be as specified by **NGET** by week 12 in each calendar year following discussion with the **Network Operator** in accordance with the **Bilateral Agreement** and will be reviewed annually by **NGET**.

(c) The distribution of the blocks will be such as to give a reasonably uniform **Disconnection** within the **Network Operator's System**, as the case may be, across all **Grid Supply Points**.

(d) Each **Network Operator** will notify **NGET** in writing by calendar week 24 each year of the details of the automatic low **Frequency Disconnection** on its **User System**. The information provided should identify, for each **Grid Supply Point** at the date and time of the annual peak of the **GB Transmission System Demand at Annual ACS Conditions** (as notified pursuant to OC1.4.2), the frequency settings at which **Demand Disconnection** will be initiated and amount of **Demand** disconnected at each such setting.

OC6.6.3 Where conditions are such that, following automatic low **Frequency Demand Disconnection**, and the subsequent **Frequency** recovery, it is not possible to restore a large proportion of the total **Demand** so disconnected within a reasonable period of time, **NGET** may instruct a **Network Operator** to implement additional **Demand Disconnection** manually, and restore an equivalent amount of the **Demand** that had been disconnected automatically. The purpose of such action is to ensure that a subsequent fall in **Frequency** will again be contained by the operation of automatic low **Frequency Demand Disconnection**.

OC6.6.4 Once an automatic low **Frequency Demand Disconnection** has taken place, the **Network Operator** on whose **User System** it has occurred, will not reconnect until **NGET** instructs that **Network Operator** to do so in accordance with **OC6**.

OC6.6.5 Once the **Frequency** has recovered, each **Network Operator** will abide by the instructions of **NGET** with regard to reconnection under OC6.6 without delay. Reconnection must be achieved as soon as possible and the process of reconnection must begin within 2 minutes of the instruction being given by **NGET**.

OC6.6.6 (a) **Non-Embedded Customers** (including a **Pumped Storage Generator**) must provide automatic low **Frequency** disconnection, which will be split into discrete blocks.

(b) The number and size of blocks and the associated low **Frequency** settings will be as specified by **NGET** by week 24 each calendar year following

discussion with the **Non-Embedded Customers** (including a **Pumped Storage Generator**) in accordance with the relevant **Bilateral Agreement**.

- OC6.6.7 (a) In addition, **Generators** may wish to disconnect **Generating Units** from the **System**, either manually or automatically, should they be subject to **Frequency** levels which could result in **Generating Unit** damage.
- (b) This **Disconnection** facility on such **Generating Unit** directly connected to the **GB Transmission System**, will be agreed with **NGET** in accordance with the **Bilateral Agreement**.
- (c) Any **Embedded Power Stations** will need to agree this **Disconnection** facility with the relevant **User** to whose **System** that **Power Station** is connected, which will then need to notify **NGET** of this.

OC6.6.8 The **Network Operator** or **Non-Embedded Customer**, as the case may be, will notify **NGET** with an estimation of the **Demand** reduction which has occurred under automatic low **Frequency Demand Disconnection** and similarly notify the restoration, as the case may be, in each case within five minutes of the **Disconnection** or restoration.

OC6.6.9 Pursuant to the provisions of OC1.5.6 the **Network Operator** and **Non-Embedded Customer** will supply to **NGET** details of the amount of **Demand** reduction or restoration actually achieved.

- OC6.6.10 (a) In the case of a **User**, it is not necessary for it to provide automatic low **Frequency** disconnection under OC6.6 only to the extent that it is providing, at the time it would be so needed, low **Frequency** disconnection at a higher level of **Frequency** as an **Ancillary Service**, namely if the amount provided as an **Ancillary Service** is less than that required under OC6.6 then the **User** must provide the balance required under OC6.6 at the time it is so needed.
- (b) The provisions of OC7.4.8 relating to the use of **Demand Control** should be borne in mind by **Users**.

OC6.7 EMERGENCY MANUAL DISCONNECTION

OC6.7.1 Each **Network Operator** will make arrangements that will enable it, following an instruction from **NGET**, to disconnect **Customers** on its **User System** under emergency conditions irrespective of **Frequency** within 30 minutes. It must be possible to apply the **Demand Disconnections** to individual or specific groups of **Grid Supply Points**, as determined by **NGET**.

- OC6.7.2 (a) Each **Network Operator** shall provide **NGET** in writing by week 24 in each calendar year, in respect of the next following year beginning week 24, on a **Grid Supply Point** basis, with the following information (which is set out in a tabular format in the Appendix):
- (i) its total peak **Demand** (based on **Annual ACS Conditions**); and
- (ii) the percentage value of the total peak **Demand** that can be disconnected (and in the case of that in the first 5 minutes it must

include that which can also be reduced by voltage reduction) within timescales of 5/10/15/20/25/30 minutes.

- (b) The information should include, in relation to the first 5 minutes, as a minimum, the 20% of **Demand** that must be reduced on instruction under OC6.5.

OC6.7.3 Each **Network Operator** will abide by the instructions of **NGET** with regard to **Disconnection** under OC6.7 without delay, and the **Disconnection** must be achieved as soon as possible after the instruction being given by **NGET**, and in any case, within the timescale registered in OC6.7. The instruction may relate to an individual **Grid Supply Point** and/or groups of **Grid Supply Points**.

OC6.7.4 **NGET** will notify a **Network Operator** who has been instructed under OC6.7, of what has happened on the **GB Transmission System** to necessitate the instruction, in accordance with the provisions of **OC7** and, if relevant, **OC10**.

OC6.7.5 Once a **Disconnection** has been applied by a **Network Operator** at the instruction of **NGET**, that **Network Operator** will not reconnect until **NGET** instructs it to do so in accordance with **OC6**.

OC6.7.6 Each **Network Operator** will abide by the instructions of **NGET** with regard to reconnection under OC6.7 without delay, and shall not reconnect until it has received such instruction and reconnection must be achieved as soon as possible and the process of reconnection must begin within 2 minutes of the instruction being given by **NGET**.

OC6.7.7 **NGET** may itself disconnect manually and reconnect **Non-Embedded Customers** as part of a **Demand Control** requirement under emergency conditions.

OC6.7.8 If **NGET** determines that emergency manual **Disconnection** referred to in OC6.7 is inadequate, **NGET** may disconnect **Network Operators** and/or **Non-Embedded Customers** at **Grid Supply Points**, to preserve the security of the **GB Transmission System**.

OC6.7.9 Pursuant to the provisions of OC1.5.6 the **Network Operator** will supply to **NGET** details of the amount of **Demand** reduction or restoration actually achieved.

OC6.8 OPERATION OF THE **BALANCING MECHANISM** DURING **DEMAND CONTROL**

Demand Control will constitute an **Emergency Instruction** in accordance with BC2.9 and it may be necessary to depart from normal **Balancing Mechanism** operation in accordance with BC2 in issuing **Bid-Offer Acceptances**. **NGET** will inform affected **BM Participants** in accordance with the provisions of **OC7**.

APPENDIX

EMERGENCY MANUAL DEMAND REDUCTION/DISCONNECTION SUMMARY SHEET
(As set out in OC6.7)

NETWORK OPERATOR _____ [YEAR] PEAK: _____

GRID SUPPLY POINT (Name)	PEAK MW	% OF GROUP DEMAND DISCONNECTION (AND/OR REDUCTION IN THE CASE OF THE FIRST 5 MINUTES) (CUMULATIVE)						REMARKS
		TIME (MINS)						
		5	10	15	20	25	30	

Notes: 1. Data to be provided annually by week 24 to cover the following year.

< End of OC6 >

OPERATING CODE NO.7

OPERATIONAL LIAISON

CONTENTS

(This contents page does not form part of the Grid Code)

<u>Paragraph No/Title</u>	<u>Page Number</u>
OC7.1 INTRODUCTION	1
OC7.2 OBJECTIVE	1
OC7.3 SCOPE	2
OC7.4 PROCEDURE	2
OC7.4.5 Requirement to notify Operations	3
OC7.4.5.1 Operation on the GB Transmission System	3
OC7.4.5.2 Operation on a User's System	3
OC7.4.5.3 Examples of situations where notification by NGET or a User may be required	3
OC7.4.5.4 Operations caused by another Operation or by an Event	3
OC7.4.5.5 Form	3
OC7.4.5.12 Timing	6
OC7.4.6 Requirements to notify Events	6
OC7.4.6.1 Events on the GB Transmission System	6
OC7.4.6.2 Events on a User's System	6
OC7.4.6.3 Events caused by another Event or by an Operation	6
OC7.4.6.5 Examples of situations where notification by NGET or a User may be required	6
Form	7
Timing	9
OC7.4.7 Significant Incidents	10
OC7.4.8 GB TRANSMISSION SYSTEM WARNINGS	10
OC7.4.8.1 Role of GB Transmission System Warnings	10
OC7.4.8.2 Recipients of GB Transmission System Warnings	10
OC7.4.8.3 Preparatory Action	11
OC7.4.8.4 Types of GB Transmission System Warnings	11
OC7.4.8.5 GB Transmission System Warning - Inadequate System Margin	12
OC7.4.8.6 GB Transmission System Warning - High Risk of Demand Reduction	12
OC7.4.8.7 GB Transmission System Warning - Demand Control Imminent	13
OC7.4.8.8 GB Transmission System Warning - Risk of System Disturbance	13
OC7.4.8.9 Cancellation of GB Transmission System Warning	13
OC7.4.8.10 General Management of GB Transmission System Warnings	14

OC7.5 PROCEDURE IN RELATION TO INTEGRAL EQUIPMENT TESTS..... 14

OC7.6 PROCEDURE IN RESPECT OF OPERATIONAL SWITCHING IN
SCOTLAND..... 16

APPENDIX –GB TRANSMISSION SYSTEM WARNINGS TABLE 20

OPERATING CODE NO.7

OPERATIONAL LIAISON

OC7.1 INTRODUCTION

OC7.1.1 **Operating Code No. 7 ("OC7")** sets out the requirements for the exchange of information in relation to **Operations** and/or **Events** on the **Total System** which have had (or may have had) or will have (or may have) an **Operational Effect**:

- (a) on the **GB Transmission System** in the case of an **Operation** and/or **Event** occurring on the **System** of a **User** or **Users**; and
- (b) on the **System** of a **User** or **Users** in the case of an **Operation** and/or **Event** occurring on the **GB Transmission System**.

It also describes the types of **GB Transmission System Warning** which may be issued by **NGET**.

OC7.1.2 The requirement to notify in **OC7** relates generally to notifying of what is expected to happen or what has happened and not the reasons why. However, as **OC7** provides, when an **Event** or **Operation** has occurred on the **GB Transmission System** which itself has been caused by (or exacerbated by) an **Operation** or **Event** on a **User's System**, **NGET** in reporting the **Event** or **Operation** on the **GB Transmission System** to another **User** can pass on what it has been told by the first **User** in relation to the **Operation** or **Event** on the first **User's System**.

OC7.1.3 Where an **Event** or **Operation** on the **GB Transmission System** falls to be reported by **NGET** to an **Externally Interconnected System Operator** under an **Interconnection Agreement**, **OC7** provides that in the situation where that **Event** or **Operation** has been caused by (or exacerbated by) an **Operation** or **Event** on a **User's System**, **NGET** can pass on what it has been told by the **User** in relation to the **Operation** or **Event** on that **User's System**.

OC7.1.4 **OC7** also deals with **Integral Equipment Tests**.

OC7.1.5 To reconfigure the **GB Transmission System**, **NGET** may reasonably require the assistance of a **User** to reconfigure parts of the **User System**. To reconfigure its **User System** a **User** may reasonably require the reasonable assistance of **NGET** to direct the reconfiguration of parts of the **GB Transmission System**.

OC7.1.6 **OC7.6** sets down the arrangements for the exchange of information required when configuring **Connection Sites** and parts of the **GB Transmission System** adjacent to those **Connection Sites** in Scotland. It also covers the setting up of a **Local Switching Procedure**. **NGET** shall procure that **Relevant Transmission Licensees** shall comply with section **OC7.6** and any relevant **Local Switching Procedure** where and to the extent that such matters apply to them.

OC7.2 OBJECTIVE

The objectives of **OC7** are:-

OC7.2.1 To provide for the exchange of information so that the implications of an **Operation** and/or **Event** can be considered, possible risks arising from it can be assessed and appropriate action taken by the relevant party in order to maintain the integrity of the

Total System. OC7 does not seek to deal with any actions arising from the exchange of information, but merely with that exchange.

OC7.2.2 To provide for types of **GB Transmission System Warnings** which may be issued by **NGET**.

OC7.2.3 To provide the framework for the information flow and discussion between **NGET** and certain **Users** in relation to **Integral Equipment Tests**.

OC7.2.4 To provide the procedure to be followed in respect of **Operational Switching** in Scotland.

OC7.3 SCOPE

OC7.3.1 **OC7** applies to **NGET** and to **Users**, which in **OC7** means:-

- (a) **Generators** (other than those which only have **Embedded Small Power Stations** or **Embedded Medium Power Stations**);
- (b) **Network Operators**;
- (c) **Non-Embedded Customers**;
- (d) **Suppliers** (for the purposes of **GB Transmission System Warnings**);
- (e) **Externally Interconnected System Operators** (for the purposes of **GB Transmission System Warnings**); and
- (f) **DC Converter Station** owners.

The procedure for operational liaison by **NGET** with **Externally Interconnected System Operators** is set out in the **Interconnection Agreement** with each **Externally Interconnected System Operator**.

In Scotland OC7.6 also applies to **Relevant Transmission Licensees**.

OC7.4 PROCEDURE

OC7.4.1 The term "**Operation**" means a scheduled or planned action relating to the operation of a **System** (including an **Embedded Power Station**).

OC7.4.2 The term "**Event**" means an unscheduled or unplanned (although it may be anticipated) occurrence on, or relating to, a **System** (including an **Embedded Power Station**) including, without limiting that general description, faults, incidents and breakdowns and adverse weather conditions being experienced.

OC7.4.3 The term "**Operational Effect**" means any effect on the operation of the relevant other **System** which causes the **GB Transmission System** or the **Systems** of the other **User** or **Users**, as the case may be, to operate (or be at a materially increased risk of operating) differently to the way in which they would or may have normally operated in the absence of that effect.

OC7.4.4 References in this **OC7** to a **System** of a **User** or **User's System** shall not include **Embedded Small Power Stations** or **Embedded Medium Power Stations**, unless otherwise stated.

OC7.4.5 Requirement to notify Operations

OC7.4.5.1 Operation on the GB Transmission System

In the case of an **Operation** on the **GB Transmission System**, which will have (or may have) an **Operational Effect** on the **System(s)** of a **User** or **Users**, **NGET** will notify the **User** or **Users** whose **System(s)** will, or may, in the reasonable opinion of **NGET**, be affected, in accordance with **OC7**.

OC7.4.5.2 Operation on a User's System

In the case of an **Operation** on the **System** of a **User** which will have (or may have) an **Operational Effect** on the **GB Transmission System** (including an equivalent to an **Operation** on the equivalent of a **System** of a **User** or other person connected to that **User's System** which, via that **User System**, will or may have an **Operational Effect** on the **GB Transmission System**), the **User** will notify **NGET** in accordance with **OC7**. Following notification by the **User**, **NGET** will notify any other **User** or **Users** on whose **System(s)** the **Operation** will have, or may have, in the reasonable opinion of **NGET**, an **Operational Effect**, in accordance with **OC7** and will notify any **Externally Interconnected System Operator** on whose **System** the **Operation** will have, or may have, in the reasonable opinion of **NGET**, an **Operational Effect**, if it is required to do so by the relevant **Interconnection Agreement**.

OC7.4.5.3 Examples of situations where notification by NGET or a User may be required

Whilst in no way limiting the general requirement to notify in advance set out in OC7.4.5.1 and OC7.4.5.2, the following are examples of situations where notification in accordance with OC7.4.5 will be required if they will, or may, have an **Operational Effect**:

- (a) the implementation of a planned outage of **Plant** and/or **Apparatus** which has been arranged pursuant to **OC2**;
- (b) the operation (other than, in the case of a **User**, at the instruction of **NGET**) of any circuit breaker or isolator/disconnector or any sequence or combination of the two; or
- (c) voltage control.

OC7.4.5.4 Operations caused by another Operation or by an Event

An **Operation** may be caused by another **Operation** or an **Event** on another's **System** (including an **Embedded Power Station**) (or by the equivalent of an **Event** or **Operation** on the **System** of an **Externally Interconnected System Operator** or **Interconnector User**) and in that situation the information to be notified is different to that where the **Operation** arose independently of any other **Operation** or **Event**, as more particularly provided in OC7.4.5.6.

OC7.4.5.5 Form

A notification and any response to any questions asked under OC7.4.5, of an **Operation** which has arisen independently of any other **Operation** or of an **Event**, shall be of sufficient detail to describe the **Operation** (although it need not state the

cause) and to enable the recipient of the notification reasonably to consider and assess the implications and risks arising (provided that, in the case of an **Operation** on a **User's System** which **NGET** is notifying to other **Users** under OC7.4.5.2, **NGET** will only pass on what it has been told by the **User** which has notified it) and will include the name of the individual reporting the **Operation** on behalf of **NGET** or the **User**, as the case may be. The recipient may ask questions to clarify the notification and the giver of the notification will, insofar as it is able, answer any questions raised, provided that, in the case of an **Operation** on a **User's System** which **NGET** is notifying to other **Users** under OC7.4.5.2, in answering any question, **NGET** will not pass on anything further than that which it has been told by the **User** which has notified it. **NGET** may pass on the information contained in the notification as provided in OC7.4.5.6.

- OC7.4.5.6 (a) A notification by **NGET** of an **Operation** under OC7.4.5.1 which has been caused by another **Operation** (the "first **Operation**") or by an **Event** on a **User's System**, will describe the **Operation** and will contain the information which **NGET** has been given in relation to the first **Operation** or that **Event** by the **User**. The notification and any response to any questions asked (other than in relation to the information which **NGET** is merely passing on from a **User**) will be of sufficient detail to enable the recipient of the notification reasonably to consider and assess the implications and risks arising from the **Operation** on the **GB Transmission System** and will include the name of the individual reporting the **Operation** on behalf of **NGET**. The recipient may ask questions to clarify the notification and **NGET** will, insofar as it is able, answer any questions raised, provided that in relation to the information which **NGET** is merely passing on from a **User**, in answering any question **NGET** will not pass on anything further than that which it has been told by the **User** which has notified it.
- (b) Where a **User** is reporting an **Operation** or an **Event** which itself has been caused by an incident or scheduled or planned action affecting (but not on) its **System**, the notification to **NGET** will contain the information which the **User** has been given by the person connected to its **System** in relation to that incident or scheduled or planned action (which the **User** must require, contractually or otherwise, the person connected to its **System** to give to it) and **NGET** may pass on the information contained in the notification as provided in this OC7.4.5.6.
- OC7.4.5.7 Where an **Operation** on the **GB Transmission System** falls to be reported by **NGET** under an **Interconnection Agreement** and the **Operation** has been caused by another **Operation** (the "first **Operation**") or by an **Event** on a **User's System**, **NGET** will include in that report the information which **NGET** has been given in relation to the first **Operation** or that **Event** by the **User** (including any information relating to an incident or scheduled or planned action, as provided in OC7.4.5.6).
- OC7.4.5.8 (a) A notification to a **User** by **NGET** of an **Operation** under OC7.4.5.1 which has been caused by the equivalent of an **Operation** or of an **Event** on the equivalent of a **System** of an **Externally Interconnected System Operator** or **Interconnector User**, will describe the **Operation** on the **GB Transmission System** and will contain the information which **NGET** has been given, in relation to the equivalent of an **Operation** or of an **Event** on the equivalent of a **System** of an **Externally Interconnected System Operator** or **Interconnector User**, by that **Externally Interconnected System Operator** or **Interconnector User**.

- (b) The notification and any response to any question asked (other than in relation to the information which **NGET** is merely passing on from that **Externally Interconnected System Operator** or **Interconnector User**) will be of sufficient detail to enable the recipient of the notification reasonably to consider and assess the implications and risks arising from the **Operation** on the **GB Transmission System** and will include the name of the individual reporting the **Operation** on behalf of **NGET**. The recipient may ask questions to clarify the notification and **NGET** will, insofar as it is able, answer any questions raised, provided that, in relation to the information which **NGET** is merely passing on from an **Externally Interconnected System Operator** or **Interconnector User**, in answering any question **NGET** will not pass on anything further than that which it has been told by the **Externally Interconnected System Operator** or **Interconnector User** which has notified it.

OC7.4.5.9 (a) A **Network Operator** may pass on the information contained in a notification to it from **NGET** under OC7.4.5.1, to a **Generator** with a **Generating Unit** or a **Power Park Module** connected to its **System**, or to a **DC Converter Station** owner with a **DC Converter** connected to its **System**, or to the operator of another **User System** connected to its **System** (which, for the avoidance of doubt, could be another **Network Operator**), in connection with reporting the equivalent of an **Operation** under the **Distribution Code** (or the contract pursuant to which that **Generating Unit** or **Power Park Module** or other **User System**, or to a **DC Converter Station** is connected to the **System** of that **Network Operator**) (if the **Operation** on the **GB Transmission System** caused it).

- (b) A **Generator** may pass on the information contained in a notification to it from **NGET** under OC7.4.5.1, to another **Generator** with a **Generating Unit** or a **Power Park Module** connected to its **System**, or to the operator of a **User System** connected to its **System** (which, for the avoidance of doubt, could be a **Network Operator**), if it is required (by a contract pursuant to which that **Generating Unit** or that **Power Park Module** or that **User System** is connected to its **System**) to do so in connection with the equivalent of an **Operation** on its **System** (if the **Operation** on the **GB Transmission System** caused it).

OC7.4.5.10 (a) Other than as provided in OC7.4.5.9, a **Network Operator** or a **Generator** may not pass on any information contained in a notification to it from **NGET** under OC7.4.5.1 (and an operator of a **User System** or **Generator** receiving information which was contained in a notification to a **Generator** or a **Network Operator**, as the case may be, from **NGET** under OC7.4.5.1, as envisaged in OC7.4.5.9 may not pass on this information) to any other person, but may inform persons connected to its **System** (or in the case of a **Generator** which is also a **Supplier**, inform persons to which it supplies electricity which may be affected) that there has been an incident on the **Total System**, the general nature of the incident (but not the cause of the incident) and (if known and if power supplies have been affected) an estimated time of return to service.

- (b) In the case of a **Generator** which has an **Affiliate** which is a **Supplier**, the **Generator** may inform it that there has been an incident on the **Total System**, the general nature of the incident (but not the cause of the incident) and (if known and if power supplies have been affected in a particular area) an estimated time of return to service in that area, and that **Supplier** may

pass this on to persons to which it supplies electricity which may be affected).

- (c) Each **Network Operator** and **Generator** shall use its reasonable endeavours to procure that any **Generator** or operator of a **User System** receiving information which was contained in a notification to a **Generator** or **Network Operator**, as the case may be, from **NGET** under OC7.4.5.1, which is not bound by the **Grid Code**, does not pass on any information other than as provided above.

OC7.4.5.11 The notification will, if either party requests, be recorded by the sender and dictated to the recipient, who shall record and repeat each phrase as it is received and on completion of the dictation shall repeat back the notification in full to the sender who shall confirm that it has been accurately recorded.

OC7.4.5.12 Timing

A notification under OC7.4.5 will be given as far in advance as possible and in any event shall be given in sufficient time as will reasonably allow the recipient to consider and assess the implications and risks arising.

OC7.4.6 Requirements to notify Events

OC7.4.6.1 Events on the GB Transmission System

In the case of an **Event** on the **GB Transmission System** which has had (or may have had) an **Operational Effect** on the **System(s)** of a **User** or **Users**, **NGET** will notify the **User** or **Users** whose **System(s)** have been, or may have been, in the reasonable opinion of **NGET**, affected, in accordance with **OC7**.

OC7.4.6.2 Events on a User's System

In the case of an **Event** on the **System** of a **User** which has had (or may have had) an **Operational Effect** on the **GB Transmission System**, the **User** will notify **NGET** in accordance with **OC7**.

OC7.4.6.3 Events caused by another Event or by an Operation

An **Event** may be caused (or exacerbated by) another **Event** or by an **Operation** on another's **System** (including on an **Embedded Power Station**) (or by the equivalent of an **Event** or **Operation** on the equivalent of a **System** of an **Externally Interconnected System Operator** or **Interconnector User**) and in that situation the information to be notified is different to that where the **Event** arose independently of any other **Event** or **Operation**, as more particularly provided in OC7.4.6.7.

OC7.4.6.4 **NGET** or a **User**, as the case may be, may enquire of the other whether an **Event** has occurred on the other's **System**. If it has, and the party on whose **System** the **Event** has occurred is of the opinion that it may have had an **Operational Effect** on the **System** of the party making the enquiry, it shall notify the enquirer in accordance with **OC7**.

OC7.4.6.5 Examples of situations where notification by NGET or a User may be required

Whilst in no way limiting the general requirement to notify set out in OC7.4.6.1, OC7.4.6.2 and OC7.4.6.3, the following are examples of situations where notification in accordance with OC7.4.6 will be required if they have an **Operational Effect**:

- (a) where **Plant** and/or **Apparatus** is being operated in excess of its capability or may present a hazard to personnel;
- (b) the activation of any alarm or indication of any abnormal operating condition;
- (c) adverse weather conditions being experienced;
- (d) breakdown of, or faults on, or temporary changes in the capabilities of, **Plant** and/or **Apparatus**;
- (e) breakdown of, or faults on, control, communication and metering equipment;
or
- (f) increased risk of inadvertent protection operation.

Form

OC7.4.6.6 A notification and any response to any questions asked under OC7.4.6.1 and OC7.4.6.2 of an **Event** which has arisen independently of any other **Event** or of an **Operation**, will describe the **Event**, although it need not state the cause of the **Event**, and, subject to that, will be of sufficient detail to enable the recipient of the notification reasonably to consider and assess the implications and risks arising and will include the name of the individual reporting the **Event** on behalf of **NGET** or the **User**, as the case may be. The recipient may ask questions to clarify the notification and the giver of the notification will, insofar as it is able (although it need not state the cause of the **Event**) answer any questions raised. **NGET** may pass on the information contained in the notification as provided in OC7.4.6.7.

- OC7.4.6.7
- (a) A notification (and any response to any questions asked under OC7.4.6.1) by **NGET** of (or relating to) an **Event** under OC7.4.6.1 which has been caused by (or exacerbated by) another **Event** (the "first **Event**") or by an **Operation** on a **User's System** will describe the **Event** and will contain the information which **NGET** has been given in relation to the first **Event** or that **Operation** by the **User** (but otherwise need not state the cause of the **Event**). The notification and any response to any questions asked (other than in relation to the information which **NGET** is merely passing on from a **User**) will be of sufficient detail to enable the recipient of the notification reasonably to consider and assess the implications and risks arising from the **Event** on the **GB Transmission System** and will include the name of the individual reporting the **Event** on behalf of **NGET**. The recipient may ask questions to clarify the notification and **NGET** will, insofar as it is able, answer any questions raised, provided that in relation to the information which **NGET** is merely passing on from a **User**, in answering any question **NGET** will not pass on anything further than that which it has been told by the **User** which has notified it.
 - (b) Where a **User** is reporting an **Event** or an **Operation** which itself has been caused by (or exacerbated by) an incident or scheduled or planned action affecting (but not on) its **System** the notification to **NGET** will contain the information which the **User** has been given by the person connected to its

System in relation to that incident or scheduled or planned action (which the **User** must require, contractually or otherwise, the person connected to its **System** to give to it) and **NGET** may pass on the information contained in the notification as provided in this OC7.4.6.7.

OC7.4.6.8 Where an **Event** on the **GB Transmission System** falls to be reported by **NGET** under an **Interconnection Agreement** and the **Event** has been caused by (or exacerbated by) another **Event** (the "first **Event**") or by an **Operation** on a **User's System**, **NGET** will include in that report the information which **NGET** has been given in relation to the first **Event** or that **Operation** by the **User** (including any information relating to an incident or scheduled or planned action on that **User's System**, as provided in OC7.4.6.7).

OC7.4.6.9 (a) A notification to a **User** (and any response to any questions asked under OC7.4.6.1) by **NGET** of (or relating to) an **Event** under OC7.4.6.1 which has been caused by (or exacerbated by) the equivalent of an **Event** or of an **Operation** on the equivalent of a **System** of an **Externally Interconnected System Operator** or **Interconnector User**, will describe the **Event** on the **GB Transmission System** and will contain the information which **NGET** has been given, in relation to the equivalent of an **Event** or of an **Operation** on the equivalent of a **System** of an **Externally Interconnected System Operator** or **Interconnector User**, by that **Externally Interconnected System Operator** or **Interconnector User** (but otherwise need not state the cause of the **Event**).

(b) The notification and any response to any questions asked (other than in relation to the information which **NGET** is merely passing on from that **Externally Interconnected System Operator** or **Interconnector User**) will be of sufficient detail to enable the recipient of the notification reasonably to consider and assess the implications and risks arising from the **Event** on the **GB Transmission System** and will include the name of the individual reporting the **Event** on behalf of **NGET**. The recipient may ask questions to clarify the notification and **NGET** will, insofar as it is able (although it need not state the cause of the **Event**) answer any questions raised, provided that, in relation to the information which **NGET** is merely passing on from an **Externally Interconnected System Operator** or **Interconnector User**, in answering any question **NGET** will not pass on anything further than that which it has been told by the **Externally Interconnected System Operator** or **Interconnector User** which has notified it.

OC7.4.6.10 (a) A **Network Operator** may pass on the information contained in a notification to it from **NGET** under OC7.4.6.1, to a **Generator** with a **Generating Unit** or a **Power Park Module** connected to its **System** or to a **DC Converter Station** owner with a **DC Converter** connected to its **System** or to the operator of another **User System** connected to its **System** (which, for the avoidance of doubt, could be a **Network Operator**), in connection with reporting the equivalent of an **Event** under the **Distribution Code** (or the contract pursuant to which that **Generating Unit** or **Power Park Module** or **DC Converter** or other **User System** is connected to the **System** of that **Network Operator**) (if the **Event** on the **GB Transmission System** caused or exacerbated it).

(b) A **Generator** may pass on the information contained in a notification to it from **NGET** under OC7.4.6.1, to another **Generator** with a **Generating Unit** or a **Power Park Module** connected to its **System** or to the operator of a

User System connected to its **System** (which, for the avoidance of doubt, could be a **Network Operator**), if it is required (by a contract pursuant to which that **Generating Unit** or that **Power Park Module** or that **User System** is connected to its **System**) to do so in connection with the equivalent of an **Event** on its **System** (if the **Event** on the **GB Transmission System** caused or exacerbated it).

- OC7.4.6.11 (a) Other than as provided in OC7.4.6.10, a **Network Operator** or a **Generator**, may not pass on any information contained in a notification to it from **NGET** under OC7.4.6.1 (and an operator of a **User System** or **Generator** receiving information which was contained in a notification to a **Generator** or a **Network Operator**, as the case may be, from **NGET** under OC7.4.6.1, as envisaged in OC7.4.6.10 may not pass on this information) to any other person, but may inform persons connected to its **System** (or in the case of a **Generator** which is also a **Supplier**, inform persons to which it supplies electricity which may be affected) that there has been an incident on the **Total System**, the general nature of the incident (but not the cause of the incident) and (if known and if power supplies have been affected) an estimated time of return to service.
- (b) In the case of a **Generator** which has an **Affiliate** which is a **Supplier**, the **Generator** may inform it that there has been an incident on the **Total System**, the general nature of the incident (but not the cause of the incident) and (if known and if power supplies have been affected in a particular area) an estimated time of return to service in that area, and that **Supplier** may pass this on to persons to which it supplies electricity which may be affected).
- (c) Each **Network Operator** and **Generator** shall use its reasonable endeavours to procure that any **Generator** or operator of a **User System** receiving information which was contained in a notification to a **Generator** or **Network Operator**, as the case may be, from **NGET** under OC7.4.6.1, which is not bound by the **Grid Code**, does not pass on any information other than as provided above.
- OC7.4.6.12 When an **Event** relating to a **Generating Unit**, **Power Park Module** or **DC Converter**, has been reported to **NGET** by a **Generator** or **DC Converter Station** owner under OC7.4.6 and it is necessary in order for the **Generator** or **DC Converter Station** owner to assess the implications of the **Event** on its **System** more accurately, the **Generator** or **DC Converter Station** owner may ask **NGET** for details of the fault levels from the **GB Transmission System** to that **Generating Unit**, **Power Park Module** or **DC Converter** at the time of the **Event**, and **NGET** will, as soon as reasonably practicable, give the **Generator** or **DC Converter Station** owner that information provided that **NGET** has that information.
- OC7.4.6.13 Except in an emergency situation the notification of an **Event** will, if either party requests, be recorded by the sender and dictated to the recipient, who shall record and repeat each phrase as it is received and on completion of the dictation shall repeat the notification in full to the sender who shall confirm that it has been accurately recorded.

Timing

OC7.4.6.14 A notification under OC7.4.6 shall be given as soon as possible after the occurrence of the **Event**, or time that the **Event** is known of or anticipated by the giver of the notification under **OC7**, and in any event within 15 minutes of such time.

OC7.4.7 **Significant Incidents**

OC7.4.7.1 Where a **User** notifies **NGET** of an **Event** under **OC7** which **NGET** considers has had or may have had a significant effect on the **GB Transmission System**, **NGET** will require the **User** to report that **Event** in writing in accordance with the provisions of **OC10** and will notify that **User** accordingly.

OC7.4.7.2 Where **NGET** notifies a **User** of an **Event** under **OC7** which the **User** considers has had or may have had a significant effect on that **User's System**, that **User** will require **NGET** to report that **Event** in writing in accordance with the provisions of **OC10** and will notify **NGET** accordingly.

OC7.4.7.3 **Events** which **NGET** requires a **User** to report in writing pursuant to OC7.4.7.1, and **Events** which a **User** requires **NGET** to report in writing pursuant to OC7.4.7.2, are known as "**Significant Incidents**".

OC7.4.7.4 Without limiting the general description set out in OC7.4.7.1 and OC7.4.7.2, a **Significant Incident** will include **Events** having an **Operational Effect** which result in, or may result in, the following:

- (a) operation of **Plant** and/or **Apparatus** either manually or automatically;
- (b) voltage outside statutory limits;
- (c) **Frequency** outside statutory limits; or
- (d) **System** instability.

OC 7.4.8 **GB TRANSMISSION SYSTEM WARNINGS**

OC7.4.8.1 **Role of GB Transmission System Warnings**

GB Transmission System Warnings as described below provide information relating to **System** conditions or **Events** and are intended to:

- (i) alert **Users** to possible or actual **Plant** shortage, **System** problems and/or **Demand** reductions;
- (ii) inform of the applicable period;
- (iii) indicate intended consequences for **Users**; and
- (iv) enable specified **Users** to be in a state of readiness to react properly to instructions received from **NGET**.

A table of **GB Transmission System Warnings**, set out in the Appendix to **OC7**, summarises the warnings and their usage. In the case of a conflict between the table and the provisions of the written text of **OC7**, the written text will prevail.

OC7.4.8.2 **Recipients of GB Transmission System Warnings**

- (a) Where **GB Transmission System Warnings**, (except those relating to **Demand Control Imminent**), are applicable to **System** conditions or **Events** which have widespread effect, **NGET** will notify all **Users** under **OC7**.
- (b) Where in **NGET's** judgement **System** conditions or **Events** may only have a limited effect, the **GB Transmission System Warning** will only be issued to those **Users** who are or may in **NGET's** judgement be affected.
- (c) Where a **GB Transmission System Warning - Demand Control Imminent** is issued it will only be sent to those **Users** who are likely to receive **Demand Control** instructions from **NGET**.

OC7.4.8.3 Preparatory Action

- (a) Where possible, and if required, recipients of the warnings should take such preparatory action as they deem necessary taking into account the information contained in the **GB Transmission System Warning**. All warnings will be of a form determined by **NGET** and will remain in force from the stated time of commencement until the cancellation, amendment or re-issue, as the case may be, is notified by **NGET**.
- (b) Where a **GB Transmission System Warning** has been issued to a **Network Operator** and is current, **Demand Control** should not (subject as provided below) be employed unless instructed by **NGET**. If **Demand Control** is, however, necessary to preserve the integrity of the **Network Operator's System**, then the impact upon the integrity of the **Total System** should be considered by the **Network Operator** and where practicable discussed with **NGET** prior to its implementation.

Where a **GB Transmission System Warning** has been issued to a **Supplier**, further **Customer Demand Management** (in addition to that previously notified under **OC1 - Demand Forecasts**) must only be implemented following notification to **NGET**.

- (c) **GB Transmission System Warnings** will be issued by fax, to the facsimile number(s) and locations agreed between **NGET** and **Users**, or by such electronic data transmission facilities as have been agreed. In the case of **Generators** with **Gensets** this will normally be at their **Trading Points** (if they have notified **NGET** that they have a **Trading Point**)
- (d) **Users** may at times be informed by telephone or other means of **GB Transmission System Warnings** and in these circumstances confirmation will be sent to those **Users** so notified, by fax as soon as possible.

OC7.4.8.4 Types of GB Transmission System Warnings

GB Transmission System Warnings consist of the following types:-

- (i) **GB Transmission System Warning - Inadequate System Margin**
- (ii) **GB Transmission System Warning - High Risk of Demand Reduction**
- (iii) **GB Transmission System Warning - Demand Control Imminent**
- (iv) **GB Transmission System Warning - Risk of System Disturbance**

OC7.4.8.5 **GB Transmission System Warning - Inadequate System Margin**

A **GB Transmission System Warning - Inadequate System Margin** may be issued to **Users** in accordance with OC7.4.8.2, at times when there is inadequate **System Margin**, as determined under BC1.5.4. It will contain the following information:

- (i) the period for which the warning is applicable; and
- (ii) the availability shortfall in MW; and
- (iii) intended consequences for **Users**, including notification that **Maximum Generation Service** may be instructed.

OC 7.4.8.6 **GB Transmission System Warning - High Risk of Demand Reduction**

(a) A **GB Transmission System Warning - High Risk of Demand Reduction** may be issued to **Users** in accordance with OC7.4.8.2 at times when there is inadequate **System Margin**, as determined under BC1.5.4 and in **NGET's** judgement there is increased risk of **Demand** reduction being implemented under OC6.5.1. It will contain the following information in addition to the required information in a **GB Transmission System Warning - Inadequate System Margin**:

- (i) the possible percentage level of **Demand** reduction required; and
- (ii) Specify those **Network Operators** and **Non Embedded Customers** who may subsequently receive instructions under OC6.5.1.

(b) A **GB Transmission System Warning - High Risk of Demand Reduction** may also be issued by **NGET** to those **Network Operators** and **Non Embedded Customers** who may subsequently receive instructions under OC6.5.1 relating to a **Demand** reduction in circumstances not related to inadequate **System Margin** (for example **Demand** reduction required to manage **System** overloading).

The **GB Transmission System Warning - High Risk of Demand Reduction** will specify the period during which **Demand** reduction may be required and the part of the **Total System** to which it applies and any other matters specified in OC6.5.

OC7.4.8.6.1 **Protracted Periods of Generation Shortage**

(a) Whenever **NGET** anticipates that a protracted period of generation shortage may exist a **GB Transmission System Warning - Inadequate System Margin** or **High Risk of Demand Reduction** may be issued, to give as much notice as possible to those **Network Operators** and **Non Embedded Customers** who may subsequently receive instructions under OC6.5.

(b) A **GB Transmission System Warning - High Risk of Demand Reduction** will in these instances include an estimate of the percentage of **Demand** reduction that may be required and the anticipated duration of the **Demand**

reduction. It may also include information relating to estimates of any further percentage of **Demand** reduction that may be required.

- (c) The issue of the **GB Transmission System Warning - Inadequate System Margin or High Risk of Demand Reduction** is intended to enable recipients to plan ahead on the various aspects of **Demand** reduction.

OC7.4.8.7 **GB Transmission System Warning - Demand Control Imminent**

- (a) A **GB Transmission System Warning - Demand Control Imminent**, relating to a **Demand** reduction under OC6.5, will be issued by **NGET** to **Users** in accordance with OC7.4.8.2. It will specify those **Network Operators** who may subsequently receive instructions under OC6.5.
- (b) A **GB Transmission System Warning - Demand Control Imminent**, need not be preceded by any other **GB Transmission System Warning** and will be issued when a **Demand** reduction is expected within the following 30 minutes, but will not cease to have effect after 30 minutes from its issue. However, **NGET** will either reissue the **GB Transmission System Warning - Demand Control Imminent** or cancel the **GB Transmission System Warning - Demand Control Imminent** no later than 2 hours from first issue, or from re-issue, as the case may be.

OC7.4.8.8 **GB Transmission System Warning - Risk of System Disturbance**

- (a) A **GB Transmission System Warning - Risk of System Disturbance** will be issued by **NGET** to **Users** who may be affected when **NGET** knows there is a risk of widespread and serious disturbance to the whole or part of, the **GB Transmission System**;
- (b) The **GB Transmission System Warning - Risk of System Disturbance** will contain such information as **NGET** deems appropriate;
- (c) for the duration of the **GB Transmission System Warning - Risk of System Disturbance**, each User in receipt of the **GB Transmission System Warning - Risk of System Disturbance** shall take the necessary steps to warn its operational staff and to maintain its **Plant** and/or **Apparatus** in the condition in which it is best able to withstand the anticipated disturbance;
- (d) During the period that the **GB Transmission System Warning - Risk of System Disturbance** is in effect, **NGET** may issue **Emergency Instructions** in accordance with **BC2** and it may be necessary to depart from normal **Balancing Mechanism** operation in accordance with **BC2** in issuing **Bid-Offer Acceptances**.

OC7.4.8.9 **Cancellation of GB Transmission System Warning**

- (a) **NGET** will give notification of a **Cancellation of GB Transmission System Warning** to all **Users** issued with the **GB Transmission System Warning** when in **NGET's** judgement **System** conditions have returned to normal.

- (b) A **Cancellation of GB Transmission System Warning** will identify the type of **GB Transmission System Warning** being cancelled and the period for which it was issued. The **Cancellation of GB Transmission System Warning** will also identify any **GB Transmission System Warnings** that are still in force.

OC7.4.8.10 General Management of **GB Transmission System Warnings**

- (a) **GB Transmission System Warnings** remain in force for the period specified unless superseded or cancelled by **NGET**.
- (b) A **GB Transmission System Warning** issued for a particular period may be superseded by further related warnings. This will include **GB Transmission System Warning - Inadequate System Margin** being superseded by **GB Transmission System Warning - High Risk of Demand Reduction** and vice-versa.
- (c) In circumstances where it is necessary for the period of a **GB Transmission System Warning** to be changed:
 - (i) the period applicable may be extended by the issue of a **GB Transmission System Warning** with a period which follows on from the original period, or
 - (ii) revised or updated **GB Transmission System Warnings** will be issued where there is an overlap with the period specified in an existing **GB Transmission System Warning**, but only if the revised period also includes the full period of the existing **GB Transmission System Warning**.

In any other case the existing **GB Transmission System Warning** will be cancelled and a new one issued.

- (d) A **GB Transmission System Warning** is no longer applicable once the period has passed and to confirm this **NGET** will issue a **Cancellation of GB Transmission System Warning**.

OC7.5 PROCEDURE IN RELATION TO **INTEGRAL EQUIPMENT TESTS**

OC7.5.1 This section of the **Grid Code** deals with **Integral Equipment Tests**. It is designed to provide a framework for the exchange of relevant information and for discussion between **NGET** and certain **Users** in relation to **Integral Equipment Tests**.

OC7.5.2 An **Integral Equipment Test** :-

- (a) is carried out in accordance with the provisions of this OC7.5 at:-
 - i) a **User Site**,
 - ii) a **Transmission Site**,
 - iii) an **Embedded Large Power Station**, or,
 - iv) an **Embedded DC Converter Station**;

- (b) will normally be undertaken during commissioning or re-commissioning of **Plant** and/or **Apparatus**;
- (c) may, in the reasonable judgement of the person wishing to perform the test, cause, or have the potential to cause, an **Operational Effect** on a part or parts of the **Total System** but which with prior notice is unlikely to have a materially adverse effect on any part of the **Total System**; and
- (d) may form part of an agreed programme of work.

OC7.5.3 A set of guidance notes is available from **NGET** on request, which provide further details on suggested procedures, information flows and responsibilities.

Notification of an IET

OC7.5.4 In order to undertake an **Integral Equipment Test** (and subject to OC7.5.8 below), the **User** or **NGET**, as the case may be, (the proposer) must notify the other (the recipient) of a proposed **IET**. Reasonable advance notification must be given, taking into account the nature of the test and the circumstances which make the test necessary. This will allow recipients time to adequately assess the impact of the **IET** on their **System**.

OC7.5.5 The notification of the **IET** must normally include the following information:-

- a) the proposed date and time of the **IET**;
- b) the name of the individual and the organisation proposing the **IET**;
- c) a proposed programme of testing; and
- d) such further detail as the proposer reasonably believes the recipient needs in order to assess the effect the **IET** may have on relevant **Plant** and/or **Apparatus**.

OC7.5.6 In the case of an **IET** in connection with commissioning or re-commissioning, the test should be incorporated as part of any overall commissioning programme agreed between **NGET** and the **User**.

Response to notification of an IET

OC7.5.7 The recipient of notification of an **IET** must respond within a reasonable timescale prior to the start time of the **IET** and will not unreasonably withhold or delay acceptance of the **IET** proposal.

OC7.5.8 (a) Where **NGET** receives notification of a proposed **IET** from a **User**, **NGET** will consult those other **Users** whom it reasonably believes may be affected by the proposed **IET** to seek their views. Information relating to the proposed **IET** may be passed on by **NGET** with the prior agreement of the proposer. However it is not necessary for **NGET** to obtain the agreement of any such **User** as **IETs** should not involve the application of irregular, unusual or extreme conditions. **NGET** may however consider any comments received when deciding whether or not to agree to an **IET**.

(b) In the case of an **Embedded Large Power Station** or **Embedded DC Converter Station**, the **Generator** or **DC Converter Station** owner as the

case may be must liaise with both **NGET** and the relevant **Network Operator**. **NGET** will not agree to an **IET** relating to such **Plant** until the **Generator** or **DC Converter Station** owner has shown that it has the agreement of the relevant **Network Operator**.

- (c) A **Network Operator** will liaise with **NGET** as necessary in those instances where it is aware of an **Embedded Small Power Station** or an **Embedded Medium Power Station** which intends to perform tests which in the reasonable judgement of the **Network Operator** may cause an **Operational Effect** on the **GB Transmission System**.

OC7.5.9 The response from the recipient, following notification of an **IET** must be one of the following:-

- a) to accept the **IET** proposal;
- b) to accept the **IET** proposal conditionally subject to minor modifications such as date and time;
- c) not to agree the **IET**, but to suggest alterations to the detail and timing of the **IET** that are necessary to make the **IET** acceptable.

Final confirmation of an **IET**

OC7.5.10 The date and time of an **IET** will be confirmed between **NGET** and the **User**, together with any limitations and restrictions on operation of **Plant** and/or **Apparatus**.

OC7.5.11 The **IET** may subsequently be amended following discussion and agreement between **NGET** and the **User**.

Carrying out an **IET**

OC7.5.12 **IETs** may only take place when agreement has been reached and must be carried out in accordance with the agreed programme of testing.

OC7.5.13 The implementation of an **IET** will be notified in accordance with OC7.4.5.

OC7.5.14 Where elements of the programme of testing change during the **IET**, there must be discussion between the appropriate parties to identify whether the **IET** should continue.

OC7.6 PROCEDURE IN RESPECT OF **OPERATIONAL SWITCHING** IN SCOTLAND

OC7.6.1 This section OC7.6 of the **Grid Code** sets out the procedure to be followed for **Operational Switching** in Scotland. Its provisions are supplementary to the provisions of the rest of this **OC7**.

It is designed to set down the arrangements for **NGET**, **Users** and the **Relevant Transmission Licensees** in respect of the **Operational Switching** of **Plant** and **Apparatus** at a **Connection Site** and parts of the **GB Transmission System** adjacent to that **Connection Site**.

OC7.6.2 In general:

- (i) **NGET** is responsible for directing the configuration of the **GB Transmission System**
- (ii) Each **Relevant Transmission Licensee** is responsible for the instruction and operation of its **Plant** and **Apparatus** on its **Transmission System**
- (iii) Each **User** is responsible for the configuration, instruction and operation of its **Plant** and **Apparatus**.

Definitive schedules of these responsibilities for each **Connection Site** are contained in the relevant **Site Responsibility Schedules**.

For the avoidance of doubt, where a **User** operates **Transmission Plant** and **Apparatus** on behalf of a **Relevant Transmission Licensee**, **NGET** cannot instruct the **User** to operate that **Plant** and **Apparatus**.

Planned Operational Switching

OC7.6.3 Following the notification of an **Operation** under OC7.4.5, **NGET** and the **User** shall discuss the **Operational Switching** required. **NGET** will then discuss and agree the details of the **Operational Switching** with the **Relevant Transmission Licensee**. The **Relevant Transmission Licensee** shall then make contact with the **User** to initiate the **Operational Switching**. For the avoidance of doubt, from the time that the **Relevant Transmission Licensee** makes contact with the **User**, the **Relevant Transmission Licensee** shall then become the primary point of operational contact with the **User** in relation to **OC7** for matters which would or could affect, or would or could be affected by the **Operational Switching**.

OC7.6.4 The **User** shall be advised by the **Relevant Transmission Licensee** on the completion of the **Operational Switching**, that **NGET** shall again become the primary point of operational contact for the **User** in relation to **OC7**.

OC7.6.5 During **Operational Switching**, either the **Relevant Transmission Licensee** or the **User** may need to unexpectedly terminate the **Operational Switching**. **NGET** may also need to terminate the **Operational Switching** during the **Operational Switching**. In the event of unexpected termination of the **Operational Switching**, **NGET** shall become the primary point of operational contact for the **User** in relation to **OC7**. Following the termination of the **Operational Switching**, it will not be permitted to restart that **Operational Switching** without the parties again following the process described in OC7.6.3.

Emergencies

OC7.6.6 For **Operations** and/or **Events** that present an immediate hazard to the safety of personnel, **Plant** or **Apparatus**, the **Relevant Transmission Licensee** may:

- (i) as permitted by the **STC**, carry out **Operational Switching** of **Plant** and **Apparatus** on its **Transmission System** without reference to **NGET** and the **User**, and
- (ii) request a **User** to carry out **Operational Switching** without the **User** first receiving notification from **NGET**.

In such emergency circumstances, communication between the **Relevant Transmission Licensee** and the **User** shall normally be by telephone and will

include an exchange of names. The **User** shall use all reasonable endeavours to carry out **Operational Switching** on its **Plant** and **Apparatus** without delay. Following completion of the requested **Operational Switching**, the **Relevant Transmission Licensee** shall notify **NGET** of the **Operational Switching** which has taken place. In such emergency circumstances, the **User** may only refuse to carry out **Operational Switching** on safety grounds (relating to personnel or plant) and this must be notified to the **Relevant Transmission Licensee** immediately by telephone.

OC7.6.7 For **Operations** and/or **Events** that present an immediate hazard to the safety of personnel, **Plant** or **Apparatus**, and which require **Operational Switching** of **Plant** or **Apparatus** on a **Transmission System** in order to remove the hazard, the **User** should contact the **Relevant Transmission Licensee** directly to request **Operational Switching** of **Plant** or **Apparatus** on its **Transmission System**.

In such emergency circumstances, communication between the **Relevant Transmission Licensee** and the **User** shall normally be by telephone and will include an exchange of names. The **Relevant Transmission Licensee** shall use all reasonable endeavours to carry out **Operational Switching** on its **Plant** and **Apparatus** without delay. Following completion of the requested **Operational Switching**, the **User** shall notify **NGET** of the **Operational Switching** which has taken place. In such emergency circumstances, the **Relevant Transmission Licensee** may only refuse to carry out **Operational Switching** on safety grounds (relating to personnel or plant) and this must be notified to the **User** immediately by telephone.

OC7.6.8 Establishment of a **Local Switching Procedure**

- (a) **NGET**, a **User** or a **Relevant Transmission Licensee** may reasonably require a **Local Switching Procedure** to be established.
- (b) Where the need for a **Local Switching Procedure** arises the following provisions shall apply:-
 - (i) **NGET**, **User(s)** and the **Relevant Transmission Licensee** will discuss and agree the detail of the **Local Switching Procedure** as soon as the requirement for a **Local Switching Procedure** is identified. **NGET** will notify the **Relevant Transmission Licensee** and the affected **User(s)** and will initiate these discussions.
 - (ii) Each **Local Switching Procedure** shall be in relation to either one or more **Connection Sites** and parts of the **GB Transmission System** adjacent to the **Connection Site(s)**
 - (iii) A draft **Local Switching Procedure** shall be prepared by the **Relevant Transmission Licensee** to reflect the agreement reached and shall be sent to **NGET**.
 - (iv) When a **Local Switching Procedure** has been prepared, it shall be sent by **NGET** to the **Relevant Transmission Licensee** and **User(s)** for confirmation of its accuracy.
 - (v) The **Local Switching Procedure** shall then be signed on behalf of **NGET** and on behalf of each **User** and **Relevant Transmission Licensee** by way of written confirmation of its accuracy.

- (vi) Once agreed under this OC7.6.8, the procedure will become a **Local Switching Procedure** under the **Grid Code**, and (subject to any change pursuant to this **OC7**) will apply between **NGET**, **Relevant Transmission Licensee** and the relevant **User(s)** as if it were part of the **Grid Code**.
- (vii) Once signed, **NGET** will send a copy of the **Local Switching Procedure** to the **Relevant Transmission Licensee** and the **User(s)**.
- (viii) An agreed **Local Switching Procedure** should be referenced by relevant **Site Responsibility Schedules**.
- (ix) **NGET**, the **User(s)** and the **Relevant Transmission Licensee** must make the **Local Switching Procedure** readily available to the relevant operational staff.
- (x) If the **Relevant Transmission Licensee** or the **User(s)** become aware that a change is needed to a **Local Switching Procedure**, they must inform **NGET** immediately. Where **NGET** has been informed of a need for a change, or **NGET** proposes a change, **NGET** shall notify both the affected **User** and the **Relevant Transmission Licensee** and will initiate discussions to agree a change to the **Local Switching Procedure**. The principles applying to the establishment of a new **Local Switching Procedure** shall then apply to the discussion and agreement of any changes.

GB TRANSMISSION SYSTEM WARNINGS TABLE

OC7 APPENDIX

WARNING TYPE	Grid Code	FORM T	to : for ACTION	to : for INFORMA	TIMESCALE	WARNING OF/OR CONSEQUENCE	Response From Recipients
GB TRANSMISSION SYSTEM WARNING - Inadequate System Margin	OC7.4.8.5	Fax or other electronic means	Generators, Suppliers, Externally Interconnected System Operators, DC Converter Station owners	Network Operators, Non-Embedded Customers	All timescales when at the time there is not a high risk of Demand reduction. Primarily 1200 hours onwards for a future period.	Insufficient generation available to meet forecast Demand plus Operating Margin Notification that if not improved Demand reduction may be instructed. (Normal initial warning of insufficient System Margin)	Offers of increased availability from Generators or DC Converter Station owners and Interconnector Users. Suppliers notify NGET of any additional Customer Demand Management that they will initiate.
GB TRANSMISSION SYSTEM WARNING - High Risk of Demand Reduction	OC7.4.8.6	Fax or other electronic means	Generators, Suppliers, Network Operators, Non-Embedded Customers, Externally Interconnected System Operators, DC Converter Station owners		All timescales where there is a high risk of Demand reduction. Primarily 1200 hours onwards for a future period.	Insufficient generation available to meet forecast Demand plus Operating Margin and /or a high risk of Demand reduction being instructed. (May be issued locally as Demand reduction risk only for circuit overloads)	Offers of increased availability from Generators or DC Converter Station owners and Interconnector Users. Suppliers notify NGET of any additional Customer Demand Management that they will initiate. Specified Network Operators and Non-Embedded Customers to prepare their Demand reduction arrangements and take actions as necessary to enable compliance with NGET instructions that may follow. (Percentages of Demand reduction above 20 % may not be achieved if NGET has not issued the warning by 16.00 hours the previous day).
GB TRANSMISSION SYSTEM WARNING - Demand Control Imminent	OC7.4.8.7	Fax/ Telephone or other electronic means	Specified Users only : (to whom an instruction is to be given) Network Operators, Non-Embedded Customers	None	within 30 minutes of anticipated instruction.	Possibility of Demand reduction within 30 minutes.	Network Operators specified to prepare to take action as necessary to enable them to comply with any subsequent NGET instruction for Demand reduction.
GB TRANSMISSION SYSTEM WARNING - Risk of System Disturbance	OC7.4.8.8	Fax/ Telephone or other electronic means	Generators, DC Converter Station owners Network Operators, Non-Embedded Customers, Externally Interconnected System Operators who may be affected.	Suppliers	Control room timescales	Risk of, or widespread system disturbance to whole or part of the GB Transmission System	Recipients take steps to warn operational staff and maintain plant or apparatus such that they are best able to withstand the disturbance.

< End of OC7 >

OPERATING CODE NO.8

SAFETY CO-ORDINATION

CONTENTS

(This contents page does not form part of the Grid Code)

<u>Paragraph No/Title</u>	<u>Page Number</u>
OC8.1 INTRODUCTION	1
OC8.2 OBJECTIVE	1
OC8.3 SCOPE.....	1
OC8.4 PROCEDURE.....	2
OC8.4.1 Safety Co-ordination in England and Wales	2
OC8.4.2 Safety Co-ordination in Scotland.....	2
OC8 Appendix 1 Safety Co-ordination in England and Wales	OC8A-1
OC8 Appendix 2 Safety Co-ordination in Scotland	OC8B-1

OPERATING CODE NO.8

SAFETY CO-ORDINATION

OC8.1 INTRODUCTION

OC8.1.1 **OC8** specifies the standard procedures to be used for the co-ordination, establishment and maintenance of necessary **Safety Precautions** when work is to be carried out on or near the **GB Transmission System** or the **System** of a **User** and when there is a need for **Safety Precautions** on **HV Apparatus** on the other **System** for this work to be carried out safely. **OC8** Appendix 1 applies when work is to be carried out on or near to **Systems** in England and Wales and **OC8** Appendix 2 applies when work is to be carried out on or near to **Systems** in Scotland.

OC8.1.2 **OC8** also covers the co-ordination, establishment and maintenance of necessary safety precautions on the **Implementing Safety Co-ordinator's System** when work is to be carried out at a **User's Site** or a **Transmission Site** (as the case may be) on equipment of the **User** or a **Transmission Licensee** as the case may be where the work or equipment is near to **HV Apparatus** on the **Implementing Safety Co-ordinator's System**.

OC.8.2 OBJECTIVE

OC8.2.1 The objective of OC8 is to achieve:-

- (i) **Safety From The System** when work on or near a **System** necessitates the provision of **Safety Precautions** on another **System** on **HV Apparatus** up to a **Connection Point**; and
- (ii) **Safety From The System** when work is to be carried out at a **User's Site** or a **Transmission Site** (as the case may be) on equipment of the **User** or a **Transmission Licensee** (as the case may be) where the work or equipment is near to **HV Apparatus** on the **Implementing Safety Co-ordinator's System**.

OC8.3 SCOPE

OC8.3.1 **OC8** applies to **NGET** and to **Users**, which in **OC8** means:-

- (a) **Generators**;
- (b) **Network Operators**; and
- (c) **Non-Embedded Customers**.

In Scotland **OC8** also applies to **Relevant Transmission Licensees**.

The procedures for the establishment of safety co-ordination by **NGET** in relation to **External Interconnections** are set out in **Interconnection Agreements** with relevant persons for the **External Interconnections**.

OC8.4 PROCEDURE

OC8.4.1 Safety Co-ordination in England and Wales

OC8.4.1.1 **OC8** Appendix 1, OC8A, applies when work is to be carried out on or near to **Systems** in England and Wales or when **Safety Precautions** are required to be established in England and Wales when work is to be carried out on or near to **Systems** in Scotland.

OC8.4.2 Safety Co-ordination in Scotland

OC8.4.2.1 **OC8** Appendix 2, OC8B, applies when work is to be carried out on or near to **Systems** in Scotland or when **Safety Precautions** are required to be established in Scotland when work is to be carried out on or near to **Systems** in England or Wales.

OPERATING CODE NO.8 Appendix 1 (OC8A)

SAFETY CO-ORDINATION IN ENGLAND AND WALES

CONTENTS

(This contents page does not form part of the Grid Code)

<u>Paragraph No/Title</u>	<u>Page Number</u>
OC8A.1 INTRODUCTION	OC8A -1
OC8A.2 OBJECTIVE.....	OC8A -2
OC8A.3 SCOPE.....	OC8A -3
OC8A.4 PROCEDURE.....	OC8A -3
OC8A.4.1 Approval of Local Safety Instructions	OC8A -3
OC8A.4.2 Safety Co-ordinators	OC8A -4
OC8A.4.3 RISSP	OC8A -4
OC8A.5 SAFETY PRECAUTIONS ON HV APPARATUS	OC8A -5
OC8A.5.1 Agreement of Safety Precautions.....	OC8A -5
OC8A.5.2 Implementation of Isolation	OC8A -6
OC8A.5.3 Implementation of Earthing	OC8A -7
OC8A.5.4 RISSP Issue Procedure	OC8A -8
OC8A.5.5 RISSP Cancellation Procedure	OC8A -9
OC8A.5.6 RISSP Change Control	OC8A -9
OC8A.6 TESTING AFFECTING ANOTHER SAFETY CO-ORDINATOR'S SYSTEM	OC8A -9
OC8A.7 EMERGENCY SITUATIONS	OC8A -9
OC8A.8 SAFETY PRECAUTIONS RELATING TO WORKING ON EQUIPMENT NEAR TO THE HV SYSTEM.....	OC8A -11
OC8A.8.1 Agreement of Safety Precautions.....	OC8A -11
OC8A.8.2 Implementation of Isolation and Earthing	OC8A -12
OC8A.8.3 Permit for Work for proximity work Issue Procedure	OC8A -12
OC8A.8.4 Permit for Work for proximity work	OC8A -12

OC8A.9 LOSS OF INTEGRITY OF SAFETY PRECAUTIONS.....	OC8A -13
OC8A.10 SAFETY LOG.....	OC8A -13
APPENDIX A – RISSP-R.....	OC8A -14
APPENDIX B – RISSP-I.....	OC8A -15
APPENDIX C – FLOWCHARTS	OC8A -16
APPENDIX D – NGSC.....	OC8A -20
APPENDIX E – Form of NGET Permit for Work	OC8A -21

OPERATING CODE NO.8 APPENDIX 1 (OC8A)

SAFETY CO-ORDINATION IN ENGLAND AND WALES

OC8A.1 INTRODUCTION

OC8A.1.1 **OC8A** specifies the standard procedures to be used by **NGET** and **Users** for the co-ordination, establishment and maintenance of necessary **Safety Precautions** when work is to be carried out on or near the **GB Transmission System** in England and Wales or the **System** of a **User** in England and Wales and when there is a need for **Safety Precautions** on **HV Apparatus** on the other's **System** for this work to be carried out safely. **OC8A** applies to **NGET** and **Users** only in England and Wales. Where work is to be carried out on or near equipment in Scotland, but such work requires **Safety Precautions** to be established in England and Wales, **OC8A** should be followed by **NGET** and **Users** to establish the required **Safety Precautions** in England and Wales.

OC8B specifies the procedures to be used by the **Relevant Transmission Licensees** and **Users** in Scotland.

In this **OC8A** the term "work" includes testing, other than **System Tests** which are covered by **OC12**.

OC8A.1.2 **OC8A** also covers the co-ordination, establishment and maintenance of necessary safety precautions on the **Implementing Safety Co-ordinator's System** when work is to be carried out at a **User's Site** or a **Transmission Site** (as the case may be) on equipment of the **User** or **NGET** as the case may be where the work or equipment is near to **HV Apparatus** on the **Implementing Safety Co-ordinator's System**.

OC8A.1.3 **OC8A** does not apply to the situation where **Safety Precautions** need to be agreed solely between **Users**. **OC8A** does not apply to the situation where **Safety Precautions** need to be agreed solely between **Transmission Licensees**.

OC8A.1.4 **OC8A** does not seek to impose a particular set of **Safety Rules** on **NGET** and **Users**; the **Safety Rules** to be adopted and used by **NGET** and each **User** shall be those chosen by each.

OC8A.1.5 **Site Responsibility Schedules** document the control responsibility for each item of **Plant** and **Apparatus** for each site.

OC8A.1.6 Defined terms

OC8A.1.6.1 **Users** should bear in mind that in **OC8** only, in order that **OC8** reads more easily with the terminology used in certain **Safety Rules**, the term "**HV Apparatus**" is defined more restrictively and is used accordingly in **OC8A**. **Users** should, therefore, exercise caution in relation to this term when reading and using **OC8A**.

OC8A.1.6.2 In **OC8A** only the following terms shall have the following meanings:

- (1) "**HV Apparatus**" means **High Voltage** electrical circuits forming part of a **System**, on which **Safety From The System** may be required or on which **Safety Precautions** may be applied to allow work to be carried out on a **System**.
- (2) "**Isolation**" means the disconnection of **Apparatus** from the remainder of the **System** in which that **Apparatus** is situated by either of the following:
 - (a) an **Isolating Device** maintained in an isolating position. The isolating position must either be:
 - (i) maintained by immobilising and **Locking** the **Isolating Device** in the isolating position and affixing a **Caution Notice** to it. Where the **Isolating Device** is **Locked** with a **Safety Key**, the **Safety Key** must be secured in a **Key Safe** and the **Key Safe Key** must be, where reasonably practicable, given to the authorised site representative of the **Requesting Safety Co-Ordinator** and is to be retained in safe custody. Where not reasonably practicable the **Key Safe Key** must be retained by the authorised site representative of the **Implementing Safety Co-Ordinator** in safe custody; or
 - (ii) maintained and/or secured by such other method which must be in accordance with the **Local Safety Instructions** of **NGET** or that **User**, as the case may be; or
 - (b) an adequate physical separation which must be in accordance with, and maintained by, the method set out in the **Local Safety Instructions** of **NGET** or that **User**, as the case may be, and, if it is a part of that method, a **Caution Notice** must be placed at the point of separation.
- (3) "**Earthing**" means a way of providing a connection between conductors and earth by an **Earthing Device** which is either:
 - (i) immobilised and **Locked** in the earthing position. Where the **Earthing Device** is **Locked** with a **Safety Key**, the **Safety Key** must be secured in a **Key Safe** and the **Key Safe Key** must be, where reasonably practicable, given to the authorised site representative of the **Requesting Safety Co-Ordinator** and is to be retained in safe custody. Where not reasonably practicable the **Key Safe Key** must be retained by the authorised site representative of the **Implementing Safety Co-Ordinator** in safe custody; or
 - (ii) maintained and/or secured in position by such other method which must be in accordance with the **Local Safety Instructions** of **NGET** or that **User** as the case may be.

OC8A.1.6.3 For the purpose of the co-ordination of safety relating to **HV Apparatus** the term "**Safety Precautions**" means **Isolation** and/or **Earthing**.

OC8A.2 OBJECTIVE

- OC8A.2.1 The objective of **OC8A** is to achieve:-
- (i) **Safety From The System** when work on or near a **System** necessitates the provision of **Safety Precautions** on another **System** on **HV Apparatus** up to a **Connection Point**; and
 - (ii) **Safety From The System** when work is to be carried out at a **User's Site** or a **Transmission Site** (as the case may be) on equipment of the **User** or **NGET** (as the case may be) where the work or equipment is near to **HV Apparatus** on the **Implementing Safety Co-ordinator's System**.

OC8A.2.2 A flow chart, set out in **OC8A Appendix C**, illustrates the process utilised in **OC8A** to achieve the objective set out in OC8A.2.1. In the case of a conflict between the flow chart and the provisions of the written text of **OC8A**, the written text will prevail.

OC8A.3 SCOPE

OC8A.3.1 **OC8A** applies to **NGET** and to **Users** in England and Wales, which in OC8A means:-

- (a) **Generators**;
- (b) **Network Operators**; and
- (c) **Non-Embedded Customers**.

The procedures for the establishment of safety co-ordination by **NGET** in relation to **External Interconnections** are set out in **Interconnection Agreements** with relevant persons for the **External Interconnections**.

OC8A.4 PROCEDURE

OC8A.4.1 Approval of Local Safety Instructions

- OC8A.4.1.1
- (a) In accordance with the timing requirements of its **Bilateral Agreement**, each **User** will supply to **NGET** a copy of its **Local Safety Instructions** relating to its side of the **Connection Point** at each **Connection Site**.
 - (b) In accordance with the timing requirements of each **Bilateral Agreement**, **NGET** will supply to each **User** a copy of its **Local Safety Instructions** relating to the **Transmission** side of the **Connection Point** at each **Connection Site**.
 - (c) Prior to connection **NGET** and the **User** must have approved each other's relevant **Local Safety Instructions** in relation to **Isolation** and **Earthing**.

OC8A.4.1.2 Either party may require that the **Isolation** and/or **Earthing** provisions in the other party's **Local Safety Instructions** affecting the **Connection Site** should be made more stringent in order that approval of the other party's **Local Safety Instructions** can be given. Provided these requirements are not unreasonable, the other party will make such changes as soon as reasonably practicable. These changes may need to

cover the application of **Isolation** and/or **Earthing** at a place remote from the **Connection Site**, depending upon the **System** layout. Approval may not be withheld because the party required to approve reasonably believes the provisions relating to **Isolation** and/or **Earthing** are too stringent.

OC8A.4.1.3 If, following approval, a party wishes to change the provisions in its **Local Safety Instructions** relating to **Isolation** and/or **Earthing**, it must inform the other party. If the change is to make the provisions more stringent, then the other party merely has to note the changes. If the change is to make the provisions less stringent, then the other party needs to approve the new provisions and the procedures referred to in OC8A.4.1.2 apply.

OC8A.4.2 **Safety Co-ordinators**

OC8A.4.2.1 For each **Connection Point**, **NGET** and each **User** will at all times have nominated and available a person or persons ("**Safety Co-ordinator(s)**") to be responsible for the co-ordination of **Safety Precautions** when work is to be carried out on a **System** which necessitates the provision of **Safety Precautions** on **HV Apparatus** pursuant to **OC8A**. A **Safety Co-ordinator** may be responsible for the co-ordination of safety on **HV Apparatus** at more than one **Connection Point**.

OC8A.4.2.2 Each **Safety Co-ordinator** shall be authorised by **NGET** or a **User**, as the case may be, as competent to carry out the functions set out in **OC8A** to achieve **Safety From The System**. Confirmation from **NGET** or a **User**, as the case may be, that its **Safety Co-ordinator(s)** as a group are so authorised is dealt with in CC.5.2. Only persons with such authorisation will carry out the provisions of **OC8A**.

OC8A.4.2.3 Contact between **Safety Co-ordinators** will be made via normal operational channels, and accordingly separate telephone numbers for **Safety Co-ordinators** need not be provided. At the time of making contact, each party will confirm that they are authorised to act as a **Safety Co-ordinator**, pursuant to **OC8A**.

OC8A.4.2.4 If work is to be carried out on a **System**, or on equipment of **NGET** or a **User** near to a **System**, as provided in this **OC8A**, which necessitates the provision of **Safety Precautions** on **HV Apparatus** in accordance with the provisions of **OC8A**, the **Requesting Safety Co-ordinator** who requires the **Safety Precautions** to be provided shall contact the relevant **Implementing Safety Co-ordinator** to co-ordinate the establishment of the **Safety Precautions**.

OC8A.4.3 **RISSP**

OC8A.4.3.1 **OC8A** sets out the procedures for utilising the **RISSP**, which will be used except where dealing with equipment in proximity to the other's **System** as provided in OC8A.8. Sections OC8A.4 to OC8A.7 inclusive should be read accordingly.

OC8A.4.3.2 **NGET** will use the format of the **RISSP** forms set out in Appendix A and Appendix B to **OC8A**. That set out in **OC8A** Appendix A and designated as "RISSP-R", shall be used when **NGET** is the **Requesting Safety Co-ordinator**, and that in **OC8A** Appendix B and designated as "RISSP-I", shall be used when **NGET** is the **Implementing Safety Co-ordinator**. Proformas of RISSP-R and RISSP-I will be provided for use by **NGET** staff.

- OC8A.4.3.3 (a) **Users** may either adopt the format referred to in OC8A.4.3.2, or use an equivalent format, provided that it includes sections requiring insertion of the same information and has the same numbering of sections as RISSP-R and RISSP-I as set out in Appendices A and B respectively.
- (b) Whether **Users** adopt the format referred to in OC8A.4.3.2, or use the equivalent format as above, the format may be produced and held in, and retrieved from an electronic form by the **User**.
- (c) Whichever method **Users** choose, each must provide proformas (whether in tangible or electronic form) for use by its staff.
- OC8A.4.3.4 All references to RISSP-R and RISSP-I shall be taken as referring to the corresponding parts of the alternative forms or other tangible written or electronic records used by each **User**.
- OC8A.4.3.5 RISSP-R will have an identifying number written or printed on it, comprising a prefix which identifies the location at which it is issued, and a unique (for each **User** or **NGET**, as the case may be) serial number consisting of four digits and the suffix "R".
- OC8A.4.3.6 (a) In accordance with the timing requirements set out in CC.5.2 each **User** shall apply in writing to **NGET** for **NGET's** approval of its proposed prefix.
- (b) **NGET** shall consider the proposed prefix to see if it is the same as (or confusingly similar to) a prefix used by **NGET** or another **User** and shall, as soon as possible (and in any event within ten days), respond in writing to the **User** with its approval or disapproval.
- (c) If **NGET** disapproves, it shall explain in its response why it has disapproved and will suggest an alternative prefix.
- (d) If **NGET** has disapproved, then the **User** shall either notify **NGET** in writing of its acceptance of the suggested alternative prefix or it shall apply in writing to **NGET** with revised proposals and the above procedure shall apply to that application.
- OC8A.4.3.7 The prefix allocation will be periodically circulated by **NGET** to all **Users**, for information purposes, using a National Grid Safety Circular in the form set out in **OC8A** Appendix D.

OC8A.5 **SAFETY PRECAUTIONS ON HV APPARATUS**

OC8A.5.1 **Agreement of Safety Precautions**

OC8A.5.1.1 The **Requesting Safety Co-ordinator** who requires **Safety Precautions** on another **System(s)** will contact the relevant **Implementing Safety Co-ordinator(s)** to agree the **Location** of the **Safety Precautions** to be established. This agreement will be recorded in the respective **Safety Logs**.

OC8A.5.1.2 It is the responsibility of the **Implementing Safety Co-ordinator** to ensure that adequate **Safety Precautions** are established and maintained, on his and/or another **System** connected to his **System**, to enable **Safety From The System** to be

achieved on the **HV Apparatus**, specified by the **Requesting Safety Co-ordinator** which is to be identified in Part 1.1 of the **RISSP**. Reference to another **System** in this OC8A.5.1.2 shall not include the **Requesting Safety Co-ordinator's System** which is dealt with in OC8A.5.1.3.

OC8A.5.1.3 When the **Implementing Safety Co-ordinator** is of the reasonable opinion that it is necessary for **Safety Precautions** on the **System** of the **Requesting Safety Co-ordinator**, other than on the **HV Apparatus** specified by the **Requesting Safety Co-ordinator**, which is to be identified in Part 1.1 of the **RISSP**, he shall contact the **Requesting Safety Co-ordinator** and the details shall be recorded in part 1.1 of the **RISSP** forms. In these circumstances it is the responsibility of the **Requesting Safety Co-ordinator** to establish and maintain such **Safety Precautions**.

OC8A.5.1.4 In the event of disagreement

In any case where the **Requesting Safety Co-ordinator** and the **Implementing Safety Co-ordinator** are unable to agree the **Location** of the **Isolation** and (if requested) **Earthing**, both shall be at the closest available points on the infeeds to the **HV Apparatus** on which **Safety From The System** is to be achieved as indicated on the **Operation Diagram**.

OC8A.5.2 Implementation of Isolation

OC8A.5.2.1 Following the agreement of the **Safety Precautions** in accordance with OC8A.5.1 the **Implementing Safety Co-ordinator** shall then establish the agreed **Isolation**.

OC8A.5.2.2 The **Implementing Safety Co-ordinator** shall confirm to the **Requesting Safety Co-ordinator** that the agreed **Isolation** has been established, and identify the **Requesting Safety Co-ordinator's HV Apparatus** up to the **Connection Point**, for which the **Isolation** has been provided. The confirmation shall specify:

- (a) for each **Location**, the identity (by means of **HV Apparatus** name, nomenclature and numbering or position, as applicable) of each point of **Isolation**;
- (b) whether **Isolation** has been achieved by an **Isolating Device** in the isolating position or by an adequate physical separation;
- (c) where an **Isolating Device** has been used whether the isolating position is either :
 - (i) maintained by immobilising and **Locking** the **Isolating Device** in the isolating position and affixing a **Caution Notice** to it. Where the **Isolating Device** has been **Locked** with a **Safety Key**, the confirmation shall specify that the **Safety Key** has been secured in a **Key Safe** and the **Key Safe Key** has been given to the authorised site representative of the **Requesting Safety Co-ordinator** where reasonably practicable and is to be retained in safe custody. Where not reasonably practicable (including where **Earthing** has been requested in OC8A.5.1), the confirmation shall specify that the **Key Safe Key** will be retained by the authorised site

representative of the **Implementing Safety Co-ordinator** in safe custody;
or

- (ii) maintained and/or secured by such other method which must be in accordance with the **Local Safety Instructions** of **NGET** or that **User**, as the case may be; and
- (d) where an adequate physical separation has been used that it will be in accordance with, and maintained by, the method set out in the **Local Safety Instructions** of **NGET** or that **User**, as the case may be, and, if it is a part of that method, that a **Caution Notice** has been placed at the point of separation.

The confirmation of **Isolation** shall be recorded in the respective **Safety Logs**.

OC8A.5.2.3 Following the confirmation of **Isolation** being established by the **Implementing Safety Co-ordinator** and the necessary establishment of relevant **Isolation** on the **Requesting Safety Co-ordinators System**, the **Requesting Safety Co-ordinator** will then request the implementation of **Earthing** by the **Implementing Safety Co-ordinator**, if agreed in section OC8A.5.1. If the implementation of **Earthing** has been agreed, then the authorised site representative of the **Implementing Safety Co-ordinator** shall retain any **Key Safe Key** in safe custody until any **Safety Key** used for **Earthing** has been secured in the **Key Safe**.

OC8A.5.3 Implementation of Earthing

OC8A.5.3.1 The **Implementing Safety Co-ordinator** shall then establish the agreed **Earthing**.

OC8A.5.3.2 The **Implementing Safety Co-ordinator** shall confirm to the **Requesting Safety Co-ordinator** that the agreed **Earthing** has been established, and identify the **Requesting Safety Co-ordinator's HV Apparatus** up to the **Connection Point**, for which the **Earthing** has been provided. The confirmation shall specify:

- (a) for each **Location**, the identity (by means of **HV Apparatus** name, nomenclature and numbering or position, as is applicable) of each point of **Earthing**; and
- (b) in respect of the **Earthing Device** used, whether it is:
 - (i) immobilised and **Locked** in the earthing position. Where the **Earthing Device** has been **Locked** with a **Safety Key**, that the **Safety Key** has been secured in a **Key Safe** and the **Key Safe Key** has been given to the authorised site representative of the **Requesting Safety Co-ordinator** where reasonably practicable and is to be retained in safe custody. Where not reasonably practicable, that the **Key Safe Key** will be retained by the authorised site representative of the **Implementing Safety Co-ordinator** in safe custody; or
 - (ii) maintained and/or secured in position by such other method which is in accordance with the **Local Safety Instructions** of **NGET** or the **Relevant Transmission Licensee** or that **User**, as the case may be.

The confirmation of **Earthing** shall be recorded in the respective **Safety Logs**.

OC8A.5.3.3. The **Implementing Safety Co-ordinator** shall ensure that the established **Safety Precautions** are maintained until requested to be removed by the relevant **Requesting Safety Co-ordinator**.

OC8A.5.4 **RISSP Issue Procedure**

OC8A.5.4.1 Where **Safety Precautions** on another **System(s)** are being provided to enable work on the **Requesting Safety Co-ordinator's System**, before any work commences they must be recorded by a **RISSP** being issued. The **RISSP** is applicable to **HV Apparatus** up to the **Connection Point** identified in section 1.1 of the RISSP-R and RISSP-I forms.

OC8A.5.4.2 Where **Safety Precautions** are being provided to enable work to be carried out on both sides of the **Connection Point** a **RISSP** will need to be issued for each side of the **Connection Point** with **NGET** and the respective **User** each enacting the role of **Requesting Safety Co-ordinator**. This will result in a RISSP-R and a RISSP-I form being completed by each of the **NGET** and the **User**, with each **Requesting Safety Co-ordinator** issuing a separate **RISSP** number.

OC8A.5.4.3 Once the **Safety Precautions** have been established (in accordance with OC8A.5.2 and OC8A.5.3), the **Implementing Safety Co-ordinator** shall complete parts 1.1 and 1.2 of a RISSP-I form recording the details specified in OC8A.5.1.3, OC8A.5.2.2 and OC8A.5.3.2. Where **Earthing** has not been requested, Part 1.2(b) will be completed with the words "not applicable" or "N/A". He shall then contact the **Requesting Safety Co-ordinator** to pass on these details.

OC8A.5.4.4 The **Requesting Safety Co-ordinator** shall complete Parts 1.1 and 1.2 of the RISSP-R, making a precise copy of the details received. On completion, the **Requesting Safety Co-ordinator** shall read the entries made back to the sender and check that an accurate copy has been made.

OC8A.5.4.5 The **Requesting Safety Co-ordinator** shall then issue the number of the **RISSP**, taken from the RISSP-R, to the **Implementing Safety Co-ordinator** who will ensure that the number, including the prefix and suffix, is accurately recorded in the designated space on the RISSP-I form.

OC8A.5.4.6 The **Requesting Safety Co-ordinator** and the **Implementing Safety Co-ordinator** shall complete and sign Part 1.3 of the RISSP-R and RISSP-I respectively and then enter the time and date. When signed no alteration to the **RISSP** is permitted; the **RISSP** may only be cancelled.

OC8A.5.4.7 The **Requesting Safety Co-ordinator** is then free to authorise work (including a test that does not affect the **Implementing Safety Co-ordinator's System**) in accordance with the requirements of the relevant internal safety procedures which apply to the **Requesting Safety Co-ordinator's System**. This is likely to involve the issue of safety documents or other relevant internal authorisations. Where testing is to be carried out which affects the **Implementing Safety Co-ordinator's System**, the procedure set out below in OC8A.6 shall be implemented.

OC8A.5.5 **RISSP Cancellation Procedure**

OC8A.5.5.1 When the **Requesting Safety Co-ordinator** decides that **Safety Precautions** are no longer required, he will contact the relevant **Implementing Safety Co-ordinator** to effect cancellation of the associated **RISSP**.

OC8A.5.5.2 The **Requesting Safety Co-ordinator** will inform the relevant **Implementing Safety Co-ordinator** of the **RISSP** identifying number (including the prefix and suffix), and agree it is the **RISSP** to be cancelled.

OC8A.5.5.3 The **Requesting Safety Co-ordinator** and the relevant **Implementing Safety Co-ordinator** shall then respectively complete Part 2.1 of their respective **RISSP-R** and **RISSP-I** forms and shall then exchange details. The details being exchanged shall include their respective names and time and date. On completion of the exchange of details the respective **RISSP** is cancelled. The removal of **Safety Precautions** is as set out in OC8A.5.5.4 and OC8A.5.5.5.

OC8A.5.5.4 Neither **Safety Co-ordinator** shall instruct the removal of any **Isolation** forming part of the **Safety Precautions** as part of the returning of the **HV Apparatus** to service until it is confirmed to each by each other that every earth on each side of the **Connection Point**, within the points of isolation identified on the **RISSP**, has been removed or disconnected by the provision of additional **Points of Isolation**.

OC8A.5.5.5 Subject to the provisions in OC8A.5.5.4, the **Implementing Safety Co-ordinator** is then free to arrange the removal of the **Safety Precautions**, the procedure to achieve that being entirely an internal matter for the party the **Implementing Safety Co-ordinator** is representing. Where a **Key Safe Key** has been given to the authorised site representative of the **Requesting Safety Co-ordinator**, the **Key Safe Key** must be returned to the authorised site representative of the **Implementing Safety Co-ordinator**. The only situation in which any **Safety Precautions** may be removed without first cancelling the **RISSP** in accordance with OC8A.5.5 or OC8A.5.6 is when **Earthing** is removed in the situation envisaged in OC8A.6.2(b).

OC8A.5.6 **RISSP Change Control**

Nothing in this **OC8A** prevents **NGET** and **Users** agreeing to a simultaneous cancellation and issue of a new **RISSP**, if both agree. It should be noted, however, that the effect of that under the relevant **Safety Rules** is not a matter with which the **Grid Code** deals.

OC8A.6 **TESTING AFFECTING ANOTHER SAFETY CO-ORDINATOR'S SYSTEM**

OC8A.6.1 The carrying out of the test may affect **Safety Precautions** on **RISSPs** or work being carried out which does not require a **RISSP**. Testing can, for example, include the application of an independent test voltage. Accordingly, where the **Requesting Safety Co-ordinator** wishes to authorise the carrying out of such a test to which the procedures in OC8A.6 apply he may not do so and the test will not take place unless and until the steps in (a)-(c) below have been followed and confirmation of completion has been recorded in the respective **Safety Logs**:

- (a) confirmation must be obtained from the **Implementing Safety Co-ordinator** that:
 - (i) no person is working on, or testing, or has been authorised to work on, or test, any part of its **System** or another **System(s)** (other than the **System** of the **Requesting Safety Co-ordinator**) within the points of **Isolation** identified on the **RISSP** form relating to the test which is proposed to be undertaken, and
 - (ii) no person will be so authorised until the proposed test has been completed (or cancelled) and the **Requesting Safety Co-ordinator** has notified the **Implementing Safety Co-ordinator** of its completion (or cancellation);
- (b) any other current **RISSPs** which relate to the parts of the **System** in which the testing is to take place must have been cancelled in accordance with procedures set out in OC8A.5.5;
- (c) the **Implementing Safety Co-ordinator** must agree with the **Requesting Safety Co-ordinator** to permit the testing on that part of the **System** between the points of **Isolation** identified in the **RISSP** associated with the test and the points of **Isolation** on the **Requesting Safety Co-ordinator's System**.

- OC8A.6.2
- (a) The **Requesting Safety Co-ordinator** will inform the **Implementing Safety Co-ordinator** as soon as the test has been completed or cancelled and the confirmation shall be recorded in the respective **Safety Logs**.
 - (b) When the test gives rise to the removal of **Earthing** which it is not intended to re-apply, the relevant **RISSP** associated with the test shall be cancelled at the completion or cancellation of the test in accordance with the procedure set out in either OC8A.5.5 or OC8A.5.6. Where the **Earthing** is re-applied following the completion or cancellation of the test, there is no requirement to cancel the relevant **RISSP** associated with the test pursuant to this OC8A.6.2.

OC8A.7 EMERGENCY SITUATIONS

- OC8A.7.1 There may be circumstances where **Safety Precautions** need to be established in relation to an unintended electrical connection or situations where there is an unintended risk of electrical connection between the **GB Transmission System** and a **User's System**, for example resulting from an incident where one line becomes attached or unacceptably close to another.
- OC8A.7.2 In those circumstances, if both **NGET** and the respective **User** agree, the relevant provisions of OC8A.5 will apply as if the electrical connections or potential connections were, solely for the purposes of this **OC8A**, a **Connection Point**.
- OC8A.7.3 (a) The relevant **Safety Co-ordinator** shall be that for the electrically closest existing **Connection Point** to that **User's System** or such other local **Connection Point** as may be agreed between **NGET** and the **User**, with discussions taking place between the relevant local **Safety Co-ordinators**. The

Connection Point to be used shall be known in this OC8A.7.3 as the "relevant **Connection Point**".

- (b) The **Local Safety Instructions** shall be those which apply to the relevant **Connection Point**.
- (c) The prefix for the **RISSP** will be that which applies for the relevant **Connection Point**.

OC8A.8 **SAFETY PRECAUTIONS RELATING TO WORKING ON EQUIPMENT NEAR TO THE HV SYSTEM**

OC8A.8 applies to the situation where work is to be carried out at a **User's Site** or a **Transmission Site** (as the case may be) on equipment of the **User** or **NGET** as the case may be, where the work or equipment is near to **HV Apparatus** on the **Implementing Safety Co-ordinator's System**. It does not apply to other situations to which **OC8A** applies. In this part of **OC8A**, a **Permit for Work for proximity work** is to be used, rather than the usual **RISSP** procedure, given the nature and effect of the work, all as further provided in the OC8A.8.

OC8A.8.1 Agreement of **Safety Precautions**

OC8A.8.1.1 The **Requesting Safety Co-ordinator** who requires **Safety Precautions** on another **System(s)** when work is to be carried out at a **User's Site** or a **Transmission Site** (as the case may be) on equipment of the **User** or **NGET**, as the case may be, where the work or equipment is near to **HV Apparatus** on the **Implementing Safety Co-ordinator's System** will contact the relevant **Implementing Safety Co-ordinator(s)** to agree the Location of the **Safety Precautions** to be established, having as part of this process informed the **Implementing Safety Co-ordinator** of the equipment and the work to be undertaken. The respective **Safety Co-ordinators** will ensure that they discuss the request with their authorised site representative and that the respective authorised site representatives discuss the request at the **Connection Site**. This agreement will be recorded in the respective **Safety Logs**.

OC8A.8.1.2 It is the responsibility of the **Implementing Safety Co-ordinator**, working with his authorised site representative as appropriate, to ensure that adequate **Safety Precautions** are established and maintained, on his and/or another **System** connected to his **System**, to enable **Safety From The System** to be achieved for work to be carried out at a **User's Site** or a **Transmission Site** (as the case may be) on equipment and in relation to work which is to be identified in the relevant part of the **Permit for Work for proximity work** where the work or equipment is near to **HV Apparatus** of the **Implementing Safety Co-ordinator's System** specified by the **Requesting Safety Co-ordinator**. Reference to another **System** in this OC8A.8.1.2 shall not include the **Requesting Safety Co-ordinator's System**.

OC8A.8.1.3 In the event of disagreement

In any case where the **Requesting Safety Co-ordinator** and the **Implementing Safety Co-ordinator** are unable to agree the **Location** of the **Isolation** and (if requested) **Earthing**, both shall be at the closest available points on the infeeds to the **HV Apparatus** near to which the work is to be carried out as indicated on the **Operation Diagram**.

OC8A.8.2 Implementation of Isolation and Earthing

OC8A.8.2.1 Following the agreement of the **Safety Precautions** in accordance with OC8A.8.1 the **Implementing Safety Co-ordinator** shall then establish the agreed **Isolation** and (if required) **Earthing**.

OC8A.8.2.2 The **Implementing Safety Co-ordinator** shall confirm to the **Requesting Safety Co-ordinator** that the agreed **Isolation** and (if required) **Earthing** has been established.

OC8A.8.2.3 The **Implementing Safety Co-ordinator** shall ensure that the established **Safety Precautions** are maintained until requested to be removed by the relevant **Requesting Safety Co-ordinator**.

OC8A.8.3 Permit for Work for proximity work Issue Procedure

OC8A.8.3.1 Where **Safety Precautions** on another **System(s)** are being provided to enable work to be carried out at a **User's Site** or **Transmission Site** (as the case may be) on equipment where the work or equipment is in proximity to **HV Apparatus** of the **Implementing Safety Co-ordinator**, before any work commences they must be recorded by a **Permit for Work for proximity work** being issued. The **Permit for Work for proximity work** shall identify the **Implementing Safety Co-ordinator's HV Apparatus** in proximity to the required work

OC8A.8.3.2 Once the **Safety Precautions** have been established (in accordance with OC8A.8.2), the **Implementing Safety Co-ordinator** shall agree to the issue of the **Permit for Work for proximity work** with the appropriately authorised site representative of the **Requesting Safety Co-ordinator's Site**. The **Implementing Safety Co-ordinator** will inform the **Requesting Safety Co-ordinator** of the **Permit for Work for proximity work** identifying number.

OC8A.8.3.3 The appropriately authorised site representative of the **Implementing Safety Co-ordinator** shall then issue the **Permit for Work for proximity work** to the appropriately authorised site representative of the **Requesting Safety Co-ordinator**. The **Permit for Work for proximity work** will in the section dealing with the work to be carried out, be completed to identify that the work is near the **Implementing Safety Co-ordinator's HV Apparatus**. No further details of the **Requesting Safety Co-ordinator's** work will be recorded, as that is a matter for the **Requesting Safety Co-ordinator** in relation to his work.

OC8A.8.3.4 The **Requesting Safety Co-ordinator** is then free to authorise work in accordance with the requirements of the relevant internal safety procedures which apply to the **Requesting Safety Co-ordinator's Site**. This is likely to involve the issue of safety documents or other relevant internal authorisations.

OC8A.8.4 Permit for Work for proximity work Cancellation Procedure

OC8A.8.4.1 When the **Requesting Safety Co-ordinator** decides that **Safety Precautions** are no longer required, he will contact the relevant **Implementing Safety Co-ordinator** to effect cancellation of the associated **Permit for Work for proximity work**.

OC8A.8.4.2 The **Requesting Safety Co-ordinator** will inform the relevant **Implementing Safety Co-ordinator** of the **Permit for Work for proximity work** identifying number, and

agree that the **Permit for Work for proximity work** can be cancelled. The cancellation is then effected by the appropriately authorised site representative of the **Requesting Safety Co-ordinator** returning the **Permit for Work for proximity work** to the appropriately authorised site representative of the **Implementing Safety Co-ordinator**.

OC8A.8.4.3 The **Implementing Safety Co-ordinator** is then free to arrange the removal of the **Safety Precautions**, the procedure to achieve that being entirely an internal matter for the party the **Implementing Safety Co-ordinator** is representing.

OC8A.9 LOSS OF INTEGRITY OF SAFETY PRECAUTIONS

OC8A.9.1 In any instance when any **Safety Precautions** may be ineffective for any reason the relevant **Safety Co-ordinator** shall inform the other **Safety Co-ordinator(s)** without delay of that being the case and, if requested, of the reasons why.

OC8A.10 SAFETY LOG

OC8A.10.1 **NGET** and **Users** shall maintain **Safety Logs** which shall be a chronological record of all messages relating to safety co-ordination under **OC8A** sent and received by the **Safety Co-ordinator(s)**. The **Safety Logs** must be retained for a period of not less than one year.

OC8A - APPENDIX A

[NGET]

_____ CONTROL CENTRE/SITE]

RECORD OF INTER-SYSTEM SAFETY PRECAUTIONS (RISSP-R)
(Requesting Safety Co-ordinator's Record)

RISSP NUMBER

PART 1

1.1 HV APPARATUS IDENTIFICATION

Safety Precautions have been established by the **Implementing Safety Co-ordinator** (or by another **User** on that **User's System** connected to the **Implementing Safety Co-ordinator's System**) to achieve (in so far as it is possible from that side of the **Connection Point**) **Safety From The System** on the following **HV Apparatus** on the **Requesting Safety Co-ordinator's System**: [State identity - name(s) and, where applicable, identification of the **HV circuit(s)** up to the **Connection Point**]:

Further **Safety precautions** required on the **Requesting Safety Co-ordinator's System** as notified by the **Implementing Safety Co-ordinator**.

1.2 SAFETY PRECAUTIONS ESTABLISHED

(a) **ISOLATION**

[State the **Location(s)** at which **Isolation** has been established (whether on the **Implementing Safety Co-ordinator's System** or on the **System** of another **User** connected to the **Implementing Safety Co-ordinator's System**). For each **Location**, identify each point of **Isolation**. For each point of **Isolation**, state the means by which the **Isolation** has been achieved, and whether, immobilised and **Locked**, **Caution Notice** affixed, other safety procedures applied, as appropriate.]

(b) **EARTHING**

[State the **Location(s)** at which **Earthing** has been established (whether on the **Implementing Safety Co-ordinator's System** or on the **System** of another **User** connected to the **Implementing Safety Co-ordinator's System**). For each **Location**, identify each point of **Earthing**. For each point of **Earthing**, state the means by which **Earthing** has been achieved, and whether, immobilised and **Locked**, other safety procedures applied, as appropriate].

1.3 ISSUE

I have received confirmation from _____ (name of **Implementing Safety Co-ordinator**) at _____ (location) that the **Safety Precautions** identified in paragraph 1.2 have been established and that instructions will not be issued at his location for their removal until this **RISSP** is cancelled.

Signed(Requesting Safety Co-ordinator)

at(time) on (Date)

PART 2

2.1 CANCELLATION

I have confirmed to _____ (name of the **Implementing Safety Co-ordinator**) at _____ (location) that the **Safety Precautions** set out in paragraph 1.2 are no longer required and accordingly the **RISSP** is cancelled.

Signed(Requesting Safety Co-ordinator)

at(time) on (Date)

OC8A - APPENDIX B

[NGET]

[_____] CONTROL CENTRE/SITE]

RECORD OF INTER-SYSTEM SAFETY PRECAUTIONS (RISSP-I)
(Implementing Safety Co-ordinator's Record)

PART 1

RISSP NUMBER

1.1 HV APPARATUS IDENTIFICATION

Safety Precautions have been established by the **Implementing Safety Co-ordinator** (or by another **User** on that **User's System** connected to the **Implementing Safety Co-ordinator's System**) to achieve (in so far as it is possible from that side of the **Connection Point**) **Safety From The System** on the following **HV Apparatus** on the **Requesting Safety Co-ordinator's System**: [State identity - name(s) and, where applicable, identification of the **HV** circuit(s) up to the **Connection Point**]:

Recording of notification given to the **Requesting Safety Co-ordinator** concerning further **Safety Precautions** required on the **Requesting Safety Co-ordinator's System**.

1.2 SAFETY PRECAUTIONS ESTABLISHED

(a) **ISOLATION**

[State the **Location(s)** at which **Isolation** has been established (whether on the **Implementing Safety Co-ordinator's System** or on the **System** of another **User** connected to the **Implementing Safety Co-ordinator's System**). For each **Location**, identify each point of **Isolation**. For each point of **Isolation**, state the means by which the **Isolation** has been achieved, and whether, immobilised and **Locked**, **Caution Notice** affixed, other safety procedures applied, as appropriate.]

(b) **EARTHING**

[State the **Location(s)** at which **Earthing** has been established (whether on the **Implementing Safety Co-ordinator's System** or on the **System** of another **User** connected to the **Implementing Safety Co-ordinator's System**). For each **Location**, identify each point of **Earthing**. For each point of **Earthing**, state the means by which **Earthing** has been achieved, and whether, immobilised and **Locked**, other safety procedures applied, as appropriate].

1.3 ISSUE

I have confirmed to _____ (name of **Requesting Safety Co-ordinator**) at _____ (location) that the **Safety Precautions** identified in paragraph 1.2 have been established and that instructions will not be issued at my location for their removal until this **RISSP** is cancelled.

Signed(Implementing Safety Co-ordinator)

at(time) on (Date)

PART 2

2.1 CANCELLATION

I have received confirmation from _____ (name of the **Requesting Safety Co-ordinator**) at _____ (location) that the **Safety Precautions** set out in paragraph 1.2 are no longer required and accordingly the **RISSP** is cancelled.

Signed(Implementing Safety Co-ordinator)

at(time) on (Date)

(Note: This form to be of a different colour from RISSP-R)

RISSP ISSUE PROCESS

- OC8A -

Appendix C1

Requesting Safety Co-ordinator (RSC)

Person requiring **Safety Precaution** from another **User**

Implementing Safety Co-ordinator (ISC)

Person who co-ordinates provision of **Safety Precautions**

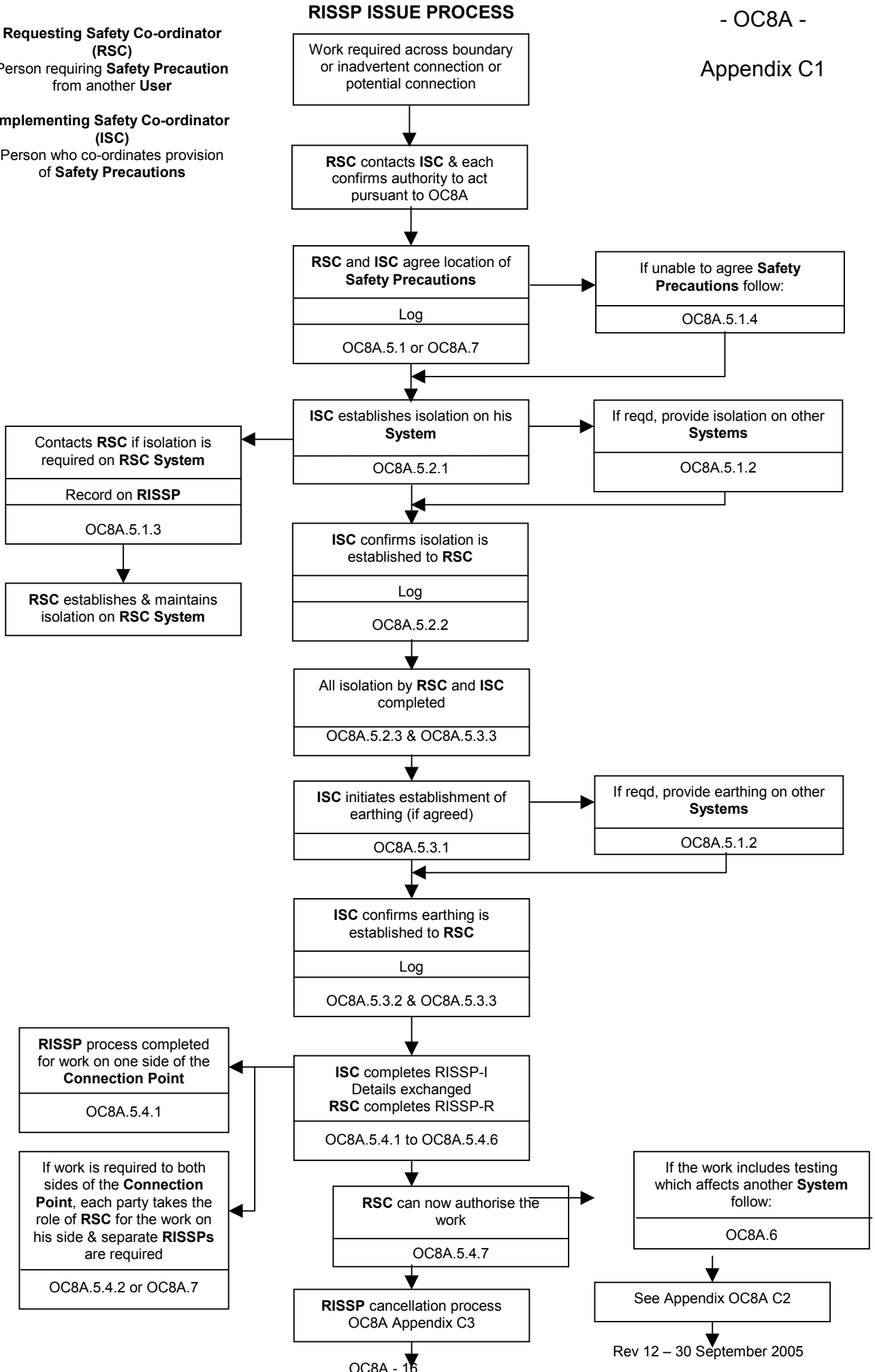

Where testing affects another Safety Co-ordinator's System

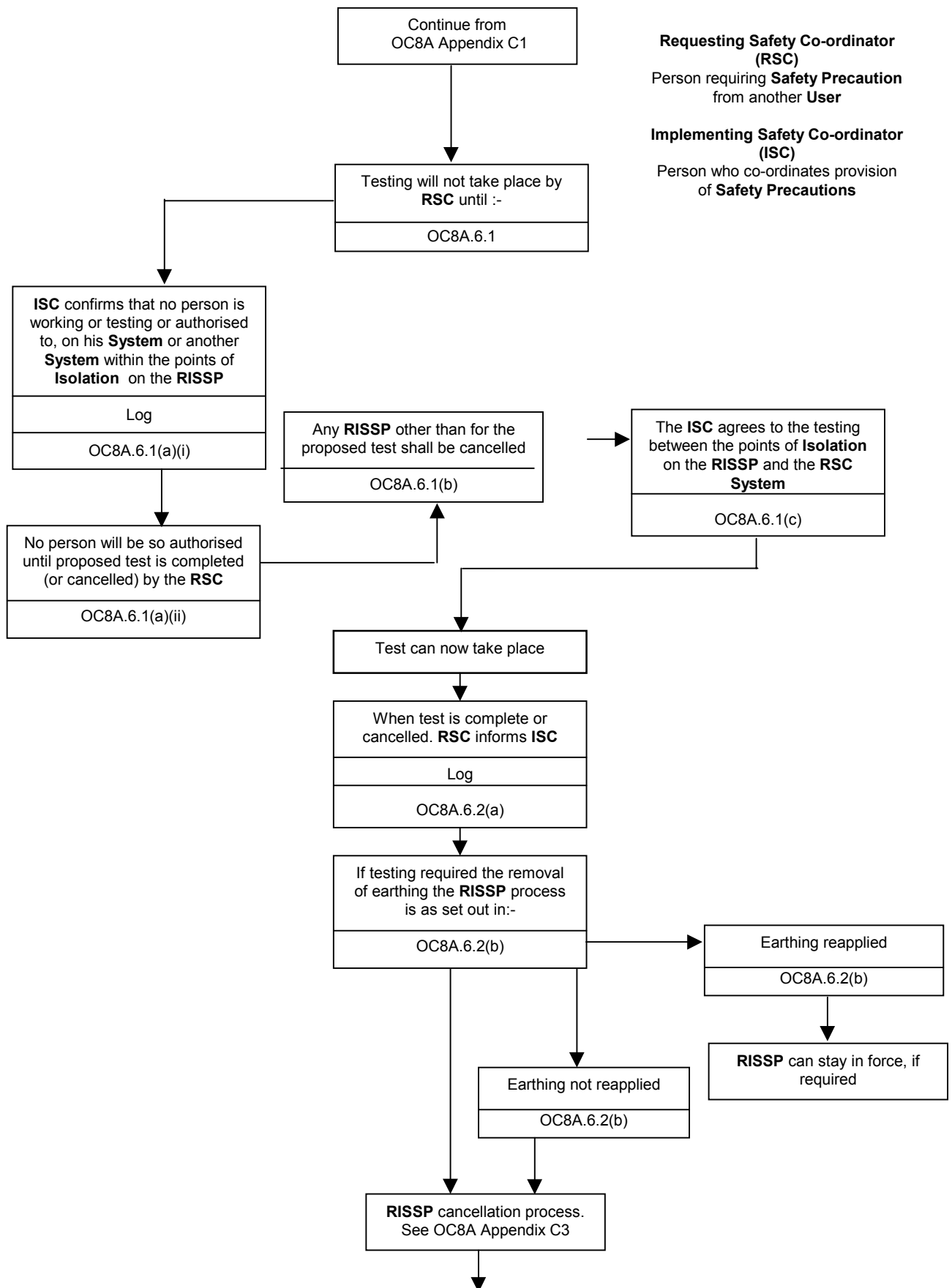

RISSP CANCELLATION PROCESS

- OC8A -

Appendix C3

Requesting Safety Co-ordinator (RSC)
Person requiring **Safety Precaution** from another **User**

Implementing Safety Co-ordinator (ISC)
Person who co-ordinates provision of **Safety Precautions**

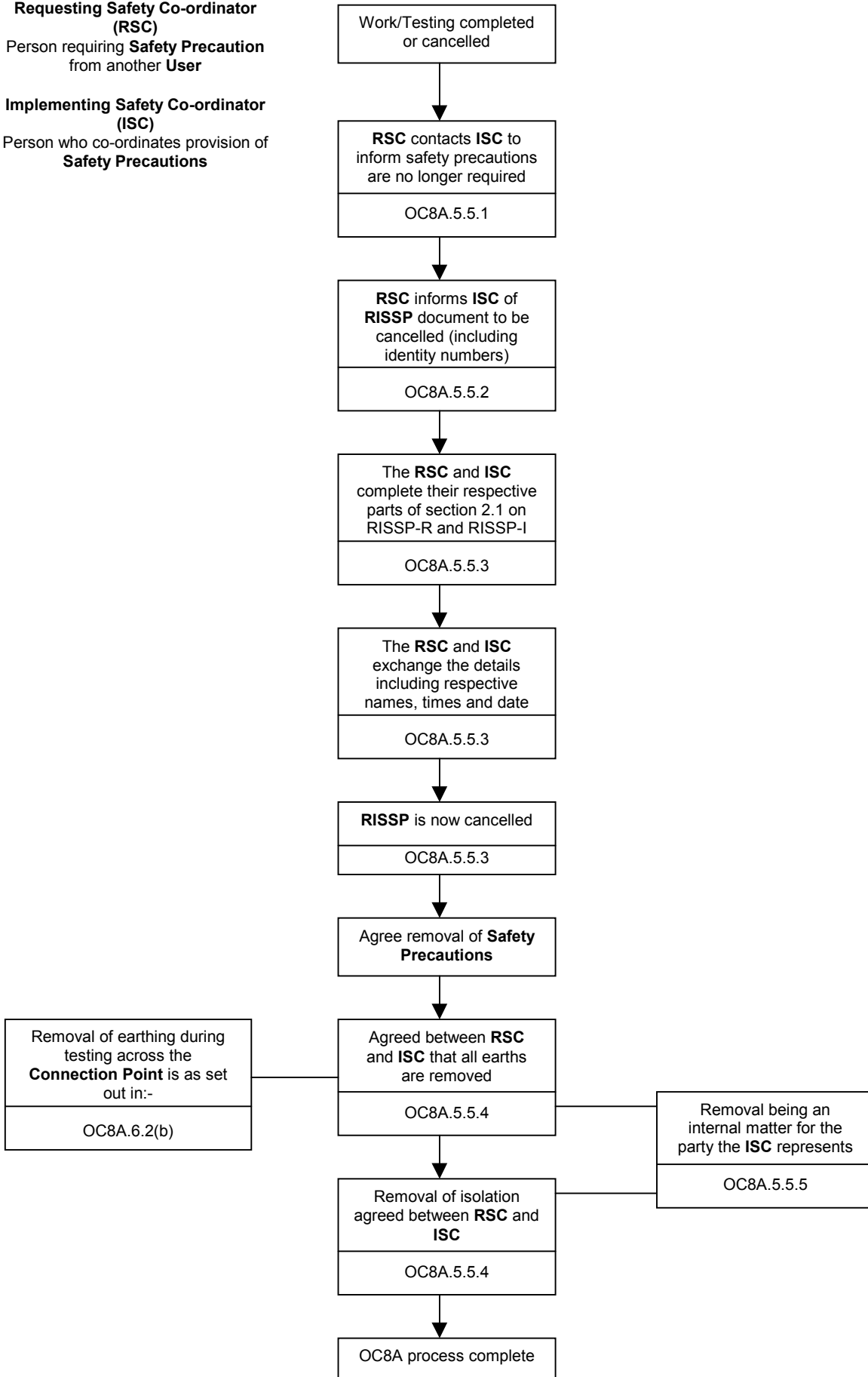

PROCESS FOR WORKING NEAR TO SYSTEM EQUIPMENT

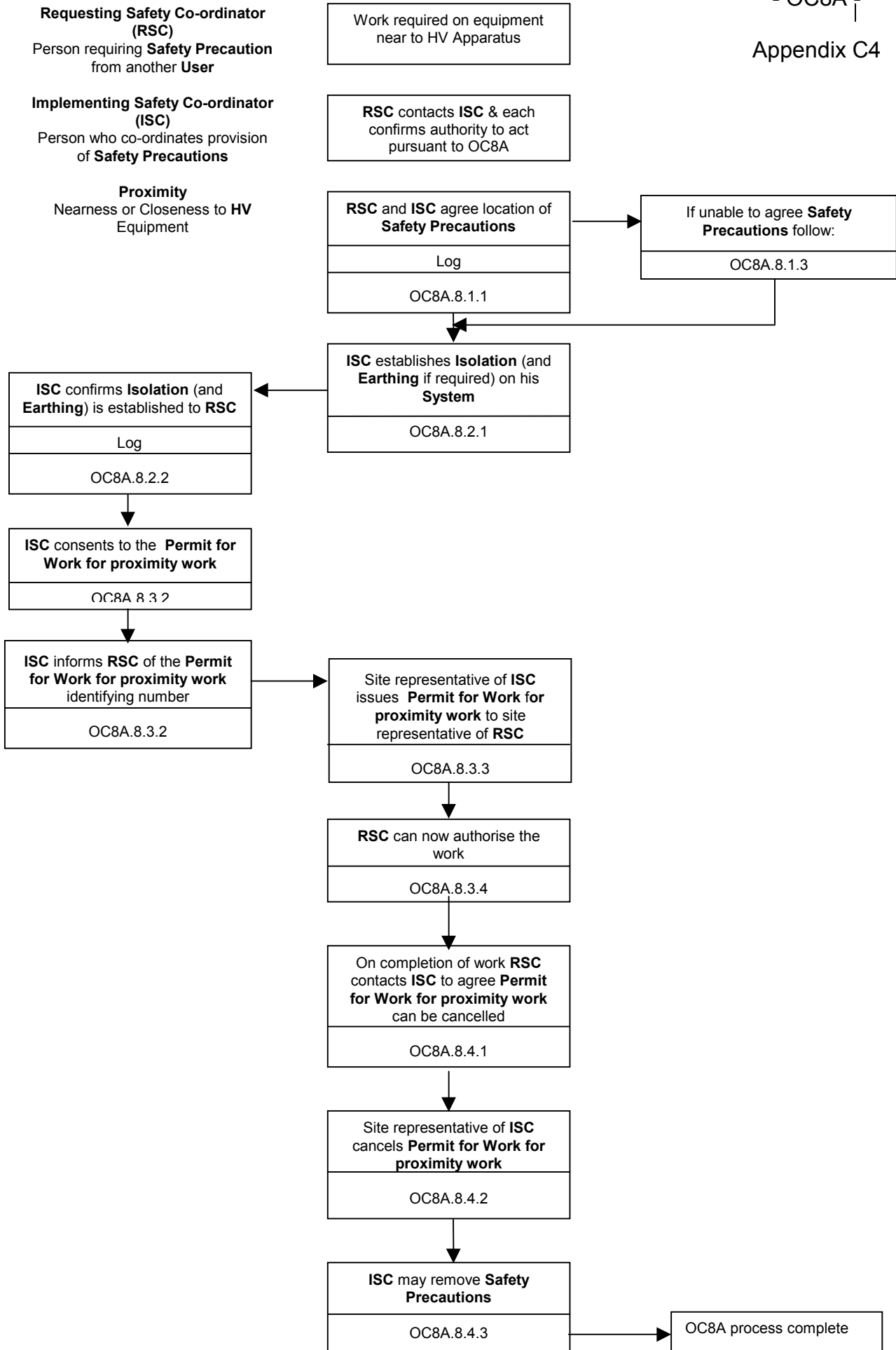

<p>National Grid Safety Circular (NGSC)</p>	<p>NGSC Number:</p>
<p>RISSP prefixes - Issue x</p>	<p>Date: Issued By:</p>
<h1>Example</h1>	

Pursuant to the objectives of The Grid Code, Operating Code 8A1 - Safety Co-ordination, this circular will be used in relation to all cross boundary safety management issues with the **NGET** customers. Of particular note will be the agreed prefixes for the Record of Inter System Safety Precautions (RISSP) documents.

OC8A APPENDIX E
[Form of NGET Permit for Work]

No.	

PERMIT FOR WORK

1.	Location Equipment Identification..... Work to be done		
2.	Precautions taken to achieve Safety from the System Points of Isolation Primary Earths Actions taken to avoid Danger by draining, venting, purging and containment or dissipation of stored energy* Further precautions to be taken during the course of the work to avoid System derived hazards*		
3.	Precautions that may be varied*		
4.	Preparation <input style="width: 200px;" type="text"/> Key Safe number* <input style="width: 50px;" type="text"/> Control Person(s) (Safety) giving Consent State whether this Permit for Work must be personally retained yes <input type="checkbox"/> no <input type="checkbox"/> Signed <input style="width: 150px;" type="text"/> Time <input style="width: 80px;" type="text"/> Date <input style="width: 80px;" type="text"/> <p align="center">Senior Authorised Person</p>		
5.	<table style="width:100%; border: none;"> <tr> <td style="width:50%; vertical-align: top;"> Issue & Receipt Key Safe Number* <input style="width: 100px;" type="text"/> Earthing Schedule Number* <input style="width: 100px;" type="text"/> Recommendations for General Safety Report Number* <input style="width: 100px;" type="text"/> Circuit Identification – Colours/ Symbols* <input style="width: 100px;" type="text"/> Issued (Signed) <input style="width: 150px;" type="text"/> <p align="center">Senior Authorised Person</p> Received (Signed) <input style="width: 150px;" type="text"/> <p align="center">Competent Person</p> Name (Block letters) <input style="width: 150px;" type="text"/> </td> <td style="width:50%; vertical-align: top;"> Safety Keys (No. off)* <input style="width: 100px;" type="text"/> Portable Drain earths (No. off)* <input style="width: 100px;" type="text"/> Approved (ROMP)#/Card Safe#/ Procedure Number* <input style="width: 100px;" type="text"/> Flags (No. off)* <input style="width: 50px;" type="text"/> Wristlets (No. off)* <input style="width: 50px;" type="text"/> Time <input style="width: 100px;" type="text"/> Date <input style="width: 80px;" type="text"/> Company <input style="width: 150px;" type="text"/> </td> </tr> </table>	Issue & Receipt Key Safe Number* <input style="width: 100px;" type="text"/> Earthing Schedule Number* <input style="width: 100px;" type="text"/> Recommendations for General Safety Report Number* <input style="width: 100px;" type="text"/> Circuit Identification – Colours/ Symbols* <input style="width: 100px;" type="text"/> Issued (Signed) <input style="width: 150px;" type="text"/> <p align="center">Senior Authorised Person</p> Received (Signed) <input style="width: 150px;" type="text"/> <p align="center">Competent Person</p> Name (Block letters) <input style="width: 150px;" type="text"/>	Safety Keys (No. off)* <input style="width: 100px;" type="text"/> Portable Drain earths (No. off)* <input style="width: 100px;" type="text"/> Approved (ROMP)#/Card Safe#/ Procedure Number* <input style="width: 100px;" type="text"/> Flags (No. off)* <input style="width: 50px;" type="text"/> Wristlets (No. off)* <input style="width: 50px;" type="text"/> Time <input style="width: 100px;" type="text"/> Date <input style="width: 80px;" type="text"/> Company <input style="width: 150px;" type="text"/>
Issue & Receipt Key Safe Number* <input style="width: 100px;" type="text"/> Earthing Schedule Number* <input style="width: 100px;" type="text"/> Recommendations for General Safety Report Number* <input style="width: 100px;" type="text"/> Circuit Identification – Colours/ Symbols* <input style="width: 100px;" type="text"/> Issued (Signed) <input style="width: 150px;" type="text"/> <p align="center">Senior Authorised Person</p> Received (Signed) <input style="width: 150px;" type="text"/> <p align="center">Competent Person</p> Name (Block letters) <input style="width: 150px;" type="text"/>	Safety Keys (No. off)* <input style="width: 100px;" type="text"/> Portable Drain earths (No. off)* <input style="width: 100px;" type="text"/> Approved (ROMP)#/Card Safe#/ Procedure Number* <input style="width: 100px;" type="text"/> Flags (No. off)* <input style="width: 50px;" type="text"/> Wristlets (No. off)* <input style="width: 50px;" type="text"/> Time <input style="width: 100px;" type="text"/> Date <input style="width: 80px;" type="text"/> Company <input style="width: 150px;" type="text"/>		

delete as appropriate *write N/A if not applicable

February 1995

< End of OC8A >

OPERATING CODE NO.8 Appendix 2 (OC8B)

SAFETY CO-ORDINATION IN SCOTLAND

CONTENTS

(This contents page does not form part of the Grid Code)

<u>Paragraph No/Title</u>	<u>Page Number</u>
OC8B.1 INTRODUCTION	OC8B - 1
OC8B.2 OBJECTIVE.....	OC8B - 3
OC8B.3 SCOPE.....	OC8B - 3
OC8B.4 PROCEDURE.....	OC8B - 3
OC8B.4.1 Approval of Safety Rules.....	OC8B - 3
OC8B.4.2 Safety Co-ordinators	OC8B - 4
OC8B.4.3 RISSP	OC8B - 5
OC8B.5 SAFETY PRECAUTIONS ON HV APPARATUS	OC8B - 6
OC8B.5.1 Agreement of Safety Precautions.....	OC8B - 6
OC8B.5.2 Implementation of Isolation	OC8B - 6
OC8B.5.3 Implementation of Earthing	OC8B - 7
OC8B.5.4 RISSP Issue Procedure	OC8B - 8
OC8B.5.5 RISSP Cancellation Procedure	OC8B - 9
OC8B.5.6 RISSP Change Control	OC8B - 10
OC8B.6 TESTING.....	OC8B - 10
OC8B.7 EMERGENCY SITUATIONS	OC8B - 10
OC8B.8 SAFETY PRECAUTIONS RELATING TO WORKING ON EQUIPMENT NEAR TO THE HV SYSTEM.....	OC8B - 11
OC8B.8.1 Agreement of Safety Precautions.....	OC8B - 11
OC8B.8.2 Implementation of Isolation and Earthing	OC8B - 12
OC8B.8.3 Permit for Work for proximity work Issue Procedure	OC8B - 12
OC8B.8.4 Permit for Work for proximity work	OC8B - 13
OC8B.9 LOSS OF INTEGRITY OF SAFETY PRECAUTIONS.....	OC8B - 13

OC8B.10 SAFETY LOG	OC8B - 13
APPENDIX A – RISSP-R	OC8B - 15
APPENDIX B – RISSP-I	OC8B - 16
APPENDIX C – FLOWCHARTS	OC8B - 18
APPENDIX D – Not Used in OC8B	OC8B - 22
APPENDIX E – Form of Permit for Work	OC8B - 23

OPERATING CODE NO.8 Appendix 2 (OC8B)

SAFETY CO-ORDINATION IN SCOTLAND

OC8B.1 INTRODUCTION

OC8B.1.1 **OC8B** specifies the standard procedures to be used by **NGET**, the **Relevant Transmission Licensees** and **Users** for the co-ordination, establishment and maintenance of necessary **Safety Precautions** when work is to be carried out on or near the **GB Transmission System** in Scotland or the **System** of a **User** in Scotland and when there is a need for **Safety Precautions** on **HV Apparatus** on the other's **System** for this work to be carried out safely. **OC8B** applies to **Relevant Transmission Licensees** and **Users** only in Scotland. Where work is to be carried out on or near equipment in England and Wales, but such work requires **Safety Precautions** to be established in Scotland, **OC8B** should be followed by the **Relevant Transmission Licensee** and **Users** to establish the required **Safety Precautions** in Scotland.

OC8A specifies the procedures to be used by **NGET** and **Users** in England and Wales.

NGET shall procure that **Relevant Transmission Licensees** shall comply with **OC8B** where and to the extent that such section applies to them.

In this **OC8B** the term “work” includes testing, other than **System Tests** which are covered by **OC12**.

OC8B.1.2 **OC8B** also covers the co-ordination, establishment and maintenance of necessary safety precautions on the **Implementing Safety Co-ordinator’s System** when work is to be carried out at a **User’s Site** or a **Transmission Site** (as the case may be) on equipment of the **User** or the **Relevant Transmission Licensee** as the case may be where the work or equipment is near to **HV Apparatus** on the **Implementing Safety Co-ordinator’s System**.

OC8B.1.3 **OC8B** does not apply to the situation where **Safety Precautions** need to be agreed solely between **Users**. **OC8B** does not apply to the situation where **Safety Precautions** need to be agreed solely between **Transmission Licensees**.

OC8B.1.4 **OC8B** does not seek to impose a particular set of **Safety Rules** on **Relevant Transmission Licensees** and **Users**. The **Safety Rules** to be adopted and used by the **Relevant Transmission Licensee** and each **User** shall be those chosen by each.

OC8B.1.5 **Site Responsibility Schedules** document the control responsibility for each item of **Plant** and **Apparatus** for each site.

OC8B.1.6 The **Relevant Transmission Licensee** may agree detailed site-specific operational procedures with **Users** for the co-ordination, establishment and maintenance of **Safety Precautions** instead of the **Record of Inter-System Safety Precautions (“RISSP”)** procedure detailed in this **OC8B**. Such operational procedures shall

satisfy the requirements of paragraphs OC8B.1.7, OC8B.2.1, OC8B.4.1, OC8B.4.2, OC8B.9, OC8B.10

OC8B.1.7 Defined terms

OC8B.1.7.1 **Users** should bear in mind that in **OC8** only, in order that **OC8** reads more easily with the terminology used in certain **Safety Rules**, the term "**HV Apparatus**" is defined more restrictively and is used accordingly in **OC8B**. **Users** should, therefore, exercise caution in relation to this term when reading and using **OC8B**.

OC8B.1.7.2 In **OC8** only the following terms shall have the following meanings:

- (1) "**HV Apparatus**" means **High Voltage** electrical circuits forming part of a **System**, on which **Safety From The System** may be required or on which **Safety Precautions** may be applied to allow work to be carried out on a **System**.
- (2) "**Isolation**" means the disconnection of **Apparatus** from the remainder of the **System** in which that **Apparatus** is situated by either of the following:
 - (a) an **Isolating Device** maintained in an isolating position. The isolating position must either be:
 - (i) maintained by immobilising and **Locking** the **Isolating Device** in the isolating position and affixing a **Caution Notice** to it. Where the **Isolating Device** is **Locked** with a **Safety Key**, the **Safety Key** must be secured in a **Key Safe** and the **Key Safe Key** must be given to the authorised site representative of the **Requesting Safety Co-ordinator** where reasonably practicable and is to be retained in safe custody. Where not reasonably practicable the **Key Safe Key** must be retained by the authorised site representative of the **Implementing Safety Co-ordinator** in safe custody; or
 - (ii) maintained and/or secured by such other method which must be in accordance with the **Safety Rules** of the **Relevant Transmission Licensee** or that **User**, as the case may be; or
 - (b) an adequate physical separation which must be in accordance with, and maintained by, the method set out in the **Safety Rules** of the **Relevant Transmission Licensee** or that **User**, as the case may be, and, if it is a part of that method, a **Caution Notice** must be placed at the point of separation.
- (3) "**Earthing**" means a way of providing a connection between conductors and earth by an **Earthing Device** which is either:
 - (i) immobilised and **Locked** in the earthing position. Where the **Earthing Device** is **Locked** with a **Safety Key**, the **Safety Key** must be secured in a **Key Safe** and the **Key Safe Key** must be given to the authorised site representative of the **Requesting Safety Co-ordinator** where reasonably practicable and is to be retained in safe custody. Where not reasonably practicable the **Key Safe Key** must be retained by the authorised site

representative of the **Implementing Safety Co-ordinator** in safe custody;
or

- (iii) maintained and/or secured in position by such other method which must be in accordance with the **Safety Rules** of the **Relevant Transmission Licensee** or that **User** as the case may be.

OC8B.1.7.3 For the purpose of the co-ordination of safety relating to **HV Apparatus** the term “**Safety Precautions**” means **Isolation** and/or **Earthing**.

OC8B.2 OBJECTIVE

OC8B.2.1 The objective of **OC8B** is to achieve:-

- (i) **Safety From The System** when work on or near a **System** necessitates the provision of **Safety Precautions** on another **System** on **HV Apparatus** up to a **Connection Point**; and
- (ii) **Safety From The System** when work is to be carried out at a **User’s Site** or a **Transmission Site** (as the case may be) on equipment of the **User** or the **Relevant Transmission Licensee** (as the case may be) where the work or equipment is near to **HV Apparatus** on the **Implementing Safety Co-ordinator’s System**.

OC8B.2.2 A flow chart, set out in **OC8B** Appendix C, illustrates the process utilised in **OC8B** to achieve the objective set out in OC8B.2.1. In the case of a conflict between the flow chart and the provisions of the written text of **OC8B**, the written text will prevail.

OC8B.3 SCOPE

OC8B.3.1 **OC8B** applies to **NGET**, **Relevant Transmission Licensees** and to **Users**, which in OC8 means:-

- (a) **Generators**;
- (b) **Network Operators**; and
- (c) **Non-Embedded Customers**.

The procedures for the establishment of safety co-ordination by **NGET** in relation to **External Interconnections** are set out in **Interconnection Agreements** with relevant persons for the **External Interconnections**.

OC8B.4 PROCEDURE

OC8B.4.1 Approval of **Safety Rules**

- OC8B.4.1.1 (a) In accordance with the timing requirements of its **Bilateral Agreement**, each **User** will supply to the **Relevant Transmission Licensee** a copy of its **Safety Rules** relating to its side of the **Connection Point** at each **Connection Site**.
- (b) In accordance with the timing requirements of each **Bilateral Agreement** the **Relevant Transmission Licensee** will supply to each **User** a copy of its **Safety Rules** relating to the **Transmission** side of the **Connection Point** at each **Connection Site**.
- (c) Prior to connection the **Relevant Transmission Licensee** and the **User** must have approved each other's relevant **Safety Rules** in relation to **Isolation** and **Earthing**.

OC8B.4.1.2 Either party may require that the **Isolation** and/or **Earthing** provisions in the other party's **Safety Rules** affecting the **Connection Site** should be made more stringent in order that approval of the other party's **Safety Rules** can be given. Provided these requirements are not unreasonable, the other party will make such changes as soon as reasonably practicable. These changes may need to cover the application of **Isolation** and/or **Earthing** at a place remote from the **Connection Site**, depending upon the **System** layout. Approval may not be withheld because the party required to approve reasonably believes the provisions relating to **Isolation** and/or **Earthing** are too stringent.

OC8B.4.1.3 If, following approval, a party wishes to change the provisions in its **Safety Rules** relating to **Isolation** and/or **Earthing**, it must inform the other party. If the change is to make the provisions more stringent, then the other party merely has to note the changes. If the change is to make the provisions less stringent, then the other party needs to approve the new provisions and the procedures referred to in OC8B.4.1.2 apply.

OC8B.4.2 **Safety Co-ordinators**

OC8B.4.2.1 For each **Connection Point**, the **Relevant Transmission Licensee** and each **User** will have nominated to be available, to a timescale agreed in the **Bilateral Agreement**, a person or persons ("**Safety Co-ordinator(s)**") to be responsible for the co-ordination of **Safety Precautions** when work is to be carried out on a **System** which necessitates the provision of **Safety Precautions** on **HV Apparatus** pursuant to **OC8B**. A **Safety Co-ordinator** may be responsible for the co-ordination of safety on **HV Apparatus** at more than one **Connection Point**.

OC8B.4.2.2 Each **Safety Co-ordinator** shall be authorised by the **Relevant Transmission Licensee** or a **User**, as the case may be, as competent to carry out the functions set out in **OC8B** to achieve **Safety From The System**. Confirmation from the **Relevant Transmission Licensee** or a **User**, as the case may be, that its **Safety Co-ordinator(s)** as a group are so authorised is dealt with, for **Users**, in CC.5.2 and for **Relevant Transmission Licensees** in the **STC**. Only persons with such authorisation will carry out the provisions of **OC8B**. Each **User** shall, prior to being connected to the **GB Transmission System**, give notice in writing to the **Relevant Transmission Licensee** of its **Safety Co-ordinator(s)** and will update the written notice yearly and whenever there is a change to the identity of its **Safety Co-ordinators** or to the **Connection Points**. The **Relevant Transmission Licensee** will, at the time of a **User** being connected to the **GB Transmission System** give notice in writing to that **User** of the identity of its **Safety Co-ordinator(s)** and will

update the written notice whenever there is a change to the **Connection Points** or **Safety Co-ordinators**.

OC8B.4.2.3 Contact between **Safety Co-ordinators** will be made via normal operational channels, and accordingly separate telephone numbers for **Safety Co-ordinators** need not be provided.

OC8B.4.2.4 If work is to be carried out on a **System**, or on equipment of the **Relevant Transmission Licensee** or a **User** near to a **System**, as provided in this **OC8B**, which necessitates the provision of **Safety Precautions** on **HV Apparatus** in accordance with the provisions of **OC8B**, the **Requesting Safety Co-ordinator** who requires the **Safety Precautions** to be provided shall contact the relevant **Implementing Safety Co-ordinator** to co-ordinate the establishment of the **Safety Precautions**.

OC8B.4.3 **RISSP**

OC8B.4.3.1 **OC8B** sets out the procedures for utilising the **RISSP**, which will be used except where dealing with equipment in proximity to the other's **System** as provided in **OC8B.8**. Sections **OC8B.4** to **OC8B.7** inclusive should be read accordingly.

OC8B.4.3.2 The **Relevant Transmission Licensee** will use the format of the **RISSP** forms set out in Appendix A and Appendix B to **OC8B**, or any other format which may be agreed between the **Relevant Transmission Licensee** and each **User**. That set out in **OC8B** Appendix A and designated as "RISSP-R", shall be used when the **Relevant Transmission Licensee** is the **Requesting Safety Co-ordinator**, and that in **OC8B** Appendix B and designated as "RISSP-I", shall be used when the **Relevant Transmission Licensee** is the **Implementing Safety Co-ordinator**. Proformas of **RISSP-R** and **RISSP-I** will be provided for use by **Relevant Transmission Licensees** staff.

OC8B.4.3.3 **Users** may either adopt the format referred to in OC8B.4.3.2 or any other format which may be agreed between the **Relevant Transmission Licensee** and the **User** from time to time.

OC8B.4.3.4 All references to **RISSP-R** and **RISSP-I** shall be taken as referring to the corresponding parts of the alternative forms or other tangible written or electronic records used by each **User** or **Relevant Transmission Licensee**.

OC8B.4.3.5 **RISSP-R** will have an identifying number written or printed on it, comprising a prefix which identifies the location at which it is issued, and a unique (for each **User** or **Relevant Transmission Licensee**, as the case may be) serial number consisting of four digits and the suffix "R".

OC8B.4.3.6 (a) In accordance with the timing requirements set out in the **Bilateral Agreement** each **User** shall apply in writing to **Relevant Transmission Licensee** for **Relevant Transmission Licensee's** approval of its proposed prefix.

(b) **Relevant Transmission Licensee** shall consider the proposed prefix to see if it is the same as (or confusingly similar to) a prefix used by **Relevant Transmission Licensee** or another **User** and shall, as soon as possible (and in any event within ten days), respond in writing to the **User** with its approval or disapproval.

- (c) If **Relevant Transmission Licensee** disapproves, it shall explain in its response why it has disapproved and will suggest an alternative prefix.
- (d) If **Relevant Transmission Licensee** has disapproved, then the **User** shall either notify **Relevant Transmission Licensee** in writing of its acceptance of the suggested alternative prefix or it shall apply in writing to **Relevant Transmission Licensee** with revised proposals and the above procedure shall apply to that application.

OC8B.5 **SAFETY PRECAUTIONS ON HV APPARATUS**

OC8B.5.1 **Agreement of Safety Precautions**

OC8B.5.1.1 The **Requesting Safety Co-ordinator** who requires **Safety Precautions** on another **System(s)** will contact the relevant **Implementing Safety Co-ordinator(s)** to agree the **Location** of the **Safety Precautions** to be established. This agreement will be recorded in the respective **Safety Logs**.

OC8B.5.1.2 It is the responsibility of the **Implementing Safety Co-ordinator** to ensure that adequate **Safety Precautions** are established and maintained, on his and/or another **System** connected to his **System**, to enable **Safety From The System** to be achieved on the **HV Apparatus**, specified by the **Requesting Safety Co-ordinator** which is to be identified in Part 1.1 of the **RISSP**. Reference to another **System** in this OC8B.5.1.2 shall not include the **Requesting Safety Co-ordinator's System** which is dealt with in OC8B.5.1.3.

OC8B.5.1.3 When the **Implementing Safety Co-ordinator** is of the reasonable opinion that it is necessary for **Safety Precautions** on the **System** of the **Requesting Safety Co-ordinator**, other than on the **HV Apparatus** specified by the **Requesting Safety Co-ordinator**, which is to be identified in Part 1.1 of the **RISSP**, he shall contact the **Requesting Safety Co-ordinator** and the details shall be recorded in part 1.1 of the **RISSP** forms. In these circumstances it is the responsibility of the **Requesting Safety Co-ordinator** to establish and maintain such **Safety Precautions**.

OC8B.5.1.4 The location of the **Safety Precautions** should be indicated on each **User's** operational diagram and labelled as per the local instructions of each **User**.

OC8B.5.1.5 **In the event of disagreement**

In any case where the **Requesting Safety Co-ordinator** and the **Implementing Safety Co-ordinator** are unable to agree the **Location** of the **Isolation** and (if requested) **Earthing**, both shall be at the closest available points on the infeeds to the **HV Apparatus** on which **Safety From The System** is to be achieved as indicated on the **Operation Diagram**.

OC8B.5.2 **Implementation of Isolation**

OC8B.5.2.1 Following the agreement of the **Safety Precautions** in accordance with OC8B.5.1 the **Implementing Safety Co-ordinator** shall then establish the agreed **Isolation**.

OC8B.5.2.2 The **Implementing Safety Co-ordinator** shall confirm to the **Requesting Safety Co-ordinator** that the agreed **Isolation** has been established, and identify the

Requesting Safety Co-ordinator's HV Apparatus up to the **Connection Point**, for which the **Isolation** has been provided. The confirmation shall specify:

- (a) for each **Location**, the identity (by means of **HV Apparatus** name, nomenclature and numbering or position, as applicable) of each point of **Isolation**;
- (b) whether **Isolation** has been achieved by an **Isolating Device** in the isolating position or by an adequate physical separation;
- (c) where an **Isolating Device** has been used whether the isolating position is either :
 - (i) maintained by immobilising and **Locking** the **Isolating Device** in the isolating position and affixing a **Caution Notice** to it. Where the **Isolating Device** has been **Locked** with a **Safety Key**, the confirmation shall specify that the **Safety Key** has been secured in a **Key Safe** and the **Key Safe Key** has been given to the authorised site representative of the **Requesting Safety Co-ordinator** where reasonably practicable and is to be retained in safe custody. Where not reasonably practicable (including where **Earthing** has been requested in OC8B.5.1), the confirmation shall specify that the **Key Safe Key** will be retained by the authorised site representative of the **Implementing Safety Co-ordinator** in safe custody; or
 - (ii) maintained and/or secured by such other method which must be in accordance with the **Safety Rules** of the **Relevant Transmission Licensee** or that **User**, as the case may be; and
- (d) where an adequate physical separation has been used that it will be in accordance with, and maintained by, the method set out in the **Safety Rules** of the **Relevant Transmission Licensee** or that **User**, as the case may be, and, if it is a part of that method, that a **Caution Notice** has been placed at the point of separation.

The confirmation of **Isolation** shall be recorded in the respective **Safety Logs**.

OC8B.5.2.3 Following the confirmation of **Isolation** being established by the **Implementing Safety Co-ordinator** and the necessary establishment of relevant **Isolation** on the **Requesting Safety Co-ordinators System**, the **Requesting Safety Co-ordinator** will then request the implementation of **Earthing** by the **Implementing Safety Co-ordinator**, if agreed in section OC8B.5.1. If the implementation of **Earthing** has been agreed, then the authorised site representative of the **Implementing Safety Co-ordinator** shall retain any **Key Safe Key** in safe custody until any **Safety Key** used for **Earthing** has been secured in the **Key Safe**.

OC8B.5.3 Implementation of Earthing

OC8B.5.3.1 The **Implementing Safety Co-ordinator** shall then establish the agreed **Earthing**.

OC8B.5.3.2 The **Implementing Safety Co-ordinator** shall confirm to the **Requesting Safety Co-ordinator** that the agreed **Earthing** has been established, and identify the

Requesting Safety Co-ordinator's HV Apparatus up to the **Connection Point**, for which the **Earthing** has been provided. The confirmation shall specify:

- (a) for each **Location**, the identity (by means of **HV Apparatus** name, nomenclature and numbering or position, as is applicable) of each point of **Earthing**; and
- (b) in respect of the **Earthing Device** used, whether it is:
 - (i) immobilised and **Locked** in the earthing position. Where the **Earthing Device** has been **Locked** with a **Safety Key**, that the **Safety Key** has been secured in a **Key Safe** and the **Key Safe Key** has been given to the authorised site representative of the **Requesting Safety Co-ordinator** where reasonably practicable and is to be retained in safe custody. Where not reasonably practicable, that the **Key Safe Key** will be retained by the authorised site representative of the **Implementing Safety Co-ordinator** in safe custody; or
 - (ii) maintained and/or secured in position by such other method which is in accordance with the **Safety Rules** of the **Relevant Transmission Licensee** or that **User**, as the case may be.

The confirmation of **Earthing** shall be recorded in the respective **Safety Logs**.

OC8B.5.3.3. The **Implementing Safety Co-ordinator** shall ensure that the established **Safety Precautions** are maintained until requested to be removed by the relevant **Requesting Safety Co-ordinator**.

OC8B.5.4 **RISSP Issue Procedure**

OC8B.5.4.1 Where **Safety Precautions** on another **System(s)** are being provided to enable work on the **Requesting Safety Co-ordinator's System**, before any work commences they must be recorded by a **RISSP** being issued. The **RISSP** is applicable to **HV Apparatus** up to the **Connection Point** identified in section 1.1 of the RISSP-R and RISSP-I forms.

OC8B.5.4.2 Where **Safety Precautions** are being provided to enable work to be carried out on both sides of the **Connection Point** a **RISSP** will need to be issued for each side of the **Connection Point** with **Relevant Transmission Licensee** and the respective **User** each enacting the role of **Requesting Safety Co-ordinator**. This will result in a RISSP-R and a RISSP-I form being completed by each of the **Relevant Transmission Licensee** and the **User**, with each **Requesting Safety Co-ordinator** issuing a separate **RISSP** number.

OC8B.5.4.3 Once the **Safety Precautions** have been established (in accordance with OC8B.5.2 and OC8B.5.3), the **Implementing Safety Co-ordinator** shall complete parts 1.1 and 1.2 of a RISSP-I form recording the details specified in OC8B.5.1.3, OC8B.5.2.2 and OC8B.5.3.2. Where **Earthing** has not been requested, Part 1.2(b) will be completed with the words "not applicable" or "N/A". He shall then contact the **Requesting Safety Co-ordinator** to pass on these details.

OC8B.5.4.4 The **Requesting Safety Co-ordinator** shall complete Parts 1.1 and 1.2 of the RISSP-R, making a precise copy of the details received. On completion, the

Requesting Safety Co-ordinator shall read the entries made back to the sender and check that an accurate copy has been made.

- OC8B.5.4.5 The **Requesting Safety Co-ordinator** shall then issue the number of the **RISSP**, taken from the RISSP-R, to the **Implementing Safety Co-ordinator** who will ensure that the number, including the prefix and suffix (where applicable), is accurately recorded in the designated space on the RISSP-I form.
- OC8B.5.4.6 The **Requesting Safety Co-ordinator** and the **Implementing Safety Co-ordinator** shall complete and sign Part 1.3 of the RISSP-R and RISSP-I respectively and then enter the time and date. When signed no alteration to the **RISSP** is permitted; the **RISSP** may only be cancelled.
- OC8B.5.4.7 The **Requesting Safety Co-ordinator** is then free to authorise work, but not testing, in accordance with the requirements of the relevant internal safety procedures which apply to the **Requesting Safety Co-ordinator's System**. This is likely to involve the issue of safety documents or other relevant internal authorisations. Where testing is to be carried out, the procedure set out below in OC8B.6 shall be implemented.
- OC8B.5.5 **RISSP Cancellation Procedure**
- OC8B.5.5.1 When the **Requesting Safety Co-ordinator** decides that **Safety Precautions** are no longer required, he will contact the relevant **Implementing Safety Co-ordinator** to effect cancellation of the associated **RISSP**.
- OC8B.5.5.2 The **Requesting Safety Co-ordinator** will inform the relevant **Implementing Safety Co-ordinator** of the **RISSP** identifying number, including the prefix and suffix (where applicable), and agree it is the **RISSP** to be cancelled.
- OC8B.5.5.3 The **Requesting Safety Co-ordinator** and the relevant **Implementing Safety Co-ordinator** shall then respectively complete Part 2.1 of their respective RISSP-R and RISSP-I forms and shall then exchange details. The details being exchanged shall include their respective names and time and date. On completion of the exchange of details the respective **RISSP** is cancelled. The removal of **Safety Precautions** is as set out in OC8B.5.5.4 and OC8B.5.5.5.
- OC8B.5.5.4 Neither **Safety Co-ordinator** shall instruct the removal of any **Isolation** forming part of the **Safety Precautions** as part of the returning of the **HV Apparatus** to service until it is confirmed to each by each other that every earth on each side of the **Connection Point**, within the points of isolation identified on the **RISSP**, has been removed or disconnected by the provision of additional **Points of Isolation**.
- OC8B.5.5.5 Subject to the provisions in OC8B.5.5.4, the **Implementing Safety Co-ordinator** is then free to arrange the removal of the **Safety Precautions**, the procedure to achieve that being entirely an internal matter for the party the **Implementing Safety Co-ordinator** is representing. Where a **Key Safe Key** has been given to the authorised site representative of the **Requesting Safety Co-ordinator**, the **Key Safe Key** must be returned to the authorised site representative of the **Implementing Safety Co-ordinator**. The only situation in which any **Safety Precautions** may be removed without first cancelling the **RISSP** in accordance with OC8B.5.5 or OC8B.5.6 is when **Earthing** is removed in the situation envisaged in OC8B.6.2(b).

OC8B.5.6 **RISSP Change Control**

Nothing in this **OC8B** prevents **Relevant Transmission Licensee** and **Users** agreeing to a simultaneous cancellation and issue of a new **RISSP**, if both agree. It should be noted, however, that the effect of that under the relevant **Safety Rules** is not a matter with which the **Grid Code** deals.

OC8B.6 **TESTING**

OC8B.6.1 The carrying out of the test may affect **Safety Precautions** on **RISSPs** or work being carried out which does not require a **RISSP**. Testing can, for example, include the application of an independent test voltage. Accordingly, where the **Requesting Safety Co-ordinator** wishes to authorise the carrying out of such a test to which the procedures in OC8B.6 apply he may not do so and the test will not take place unless and until the steps in (a)-(c) below have been followed and confirmation of completion has been recorded in the respective **Safety Logs**:

- (a) confirmation must be obtained from the **Implementing Safety Co-ordinator** that:
 - (i) no person is working on, or testing, or has been authorised to work on, or test, any part of its **System** or another **System(s)** (other than the **System** of the **Requesting Safety Co-ordinator**) within the points of **Isolation** identified on the **RISSP** form relating to the test which is proposed to be undertaken, and
 - (ii) no person will be so authorised until the proposed test has been completed (or cancelled) and the **Requesting Safety Co-ordinator** has notified the **Implementing Safety Co-ordinator** of its completion (or cancellation);
- (b) any other current **RISSPs** which relate to the parts of the **System** in which the testing is to take place must have been cancelled in accordance with procedures set out in OC8B.5.5;
- (c) the **Implementing Safety Co-ordinator** must agree with the **Requesting Safety Co-ordinator** to permit the testing on that part of the **System** between the points of **Isolation** identified in the **RISSP** associated with the test and the points of **Isolation** on the **Requesting Safety Co-ordinator's System**.

OC8B.6.2 (a) The **Requesting Safety Co-ordinator** will inform the **Implementing Safety Co-ordinator** as soon as the test has been completed or cancelled and the confirmation shall be recorded in the respective **Safety Logs**.

- (b) When the test gives rise to the removal of **Earthing** which it is not intended to re-apply, the relevant **RISSP** associated with the test shall be cancelled at the completion or cancellation of the test in accordance with the procedure set out in either OC8B.5.5 or OC8B.5.6. Where the **Earthing** is re-applied following the completion or cancellation of the test, there is no requirement to cancel the relevant **RISSP** associated with the test pursuant to this OC8B.6.2.

OC8B.7 EMERGENCY SITUATIONS

- OC8B.7.1 There may be circumstances where **Safety Precautions** need to be established in relation to an unintended electrical connection or situations where there is an unintended risk of electrical connection between the **GB Transmission System** and a **User's System**, for example resulting from an incident where one line becomes attached or unacceptably close to another.
- OC8B.7.2 In those circumstances, if both the **Relevant Transmission Licensee** the **User** agree, the relevant provisions of OC8B.5 will apply as if the electrical connections or potential connections were, solely for the purposes of this OC8B, a **Connection Point**.
- OC8B.7.3 (a) The relevant **Safety Co-ordinator** shall be that for the electrically closest existing **Connection Point** to that **User's System** or such other local **Connection Point** as may be agreed between the **Relevant Transmission Licensee** and the **User**, with discussions taking place between the relevant local **Safety Co-ordinators**. The **Connection Point** to be used shall be known in this OC8B.7.3 as the "relevant **Connection Point**".
- (c) The **Safety Rules** shall be those which apply to the relevant **Connection Point**.
- (c) The prefix for the **RISSP** (where applicable) will be that which applies for the relevant **Connection Point**.

OC8B.8 SAFETY PRECAUTIONS RELATING TO WORKING ON EQUIPMENT NEAR TO THE HV SYSTEM

OC8B.8 applies to the situation where work is to be carried out at a **User's Site** or a **Transmission Site** (as the case may be) on equipment of the **User** or a **Relevant Transmission Licensee** as the case may be, where the work or equipment is near to **HV Apparatus** on the **Implementing Safety Co-ordinator's System**. It does not apply to other situations to which **OC8B** applies. In this part of **OC8B**, a **Permit for Work for proximity work** is to be used, rather than the usual **RISSP** procedure, given the nature and effect of the work, all as further provided in the OC8B.8.

OC8B.8.1 Agreement of Safety Precautions

- OC8B.8.1.1 The **Requesting Safety Co-ordinator** who requires **Safety Precautions** on another **System(s)** when work is to be carried out at a **User's Site** or a **Transmission Site** (as the case may be) on equipment of the **User** or a **Relevant Transmission Licensee**, as the case may be, where the work or equipment is near to **HV Apparatus** on the **Implementing Safety Co-ordinator's System** will contact the relevant **Implementing Safety Co-ordinator(s)** to agree the Location of the **Safety Precautions** to be established, having as part of this process informed the **Implementing Safety Co-ordinator** of the equipment and the work to be undertaken. The respective **Safety Co-ordinators** will ensure that they discuss the request with their authorised site representative and that the respective authorised site representatives discuss the request at the **Connection Site**. This agreement will be recorded in the respective **Safety Logs**.
- OC8B.8.1.2 It is the responsibility of the **Implementing Safety Co-ordinator**, working with his authorised site representative as appropriate, to ensure that adequate **Safety**

Precautions are established and maintained, on his and/or another **System** connected to his **System**, to enable **Safety From The System** to be achieved for work to be carried out at a **User's Site** or a **Transmission Site** (as the case may be) on equipment and in relation to work which is to be identified in the relevant part of the **Permit for Work for proximity work** where the work or equipment is near to **HV Apparatus** of the **Implementing Safety Co-ordinator's System** specified by the **Requesting Safety Co-ordinator**. Reference to another **System** in this OC8B.8.1.2 shall not include the **Requesting Safety Co-ordinator's System**.

OC8B.8.1.3 In the event of disagreement

In any case where the **Requesting Safety Co-ordinator** and the **Implementing Safety Co-ordinator** are unable to agree the **Location** of the **Isolation** and (if requested) **Earthing**, both shall be at the closest available points on the infeeds to the **HV Apparatus** near to which the work is to be carried out as indicated on the **Operation Diagram**.

OC8B.8.2 Implementation of Isolation and Earthing

OC8B.8.2.1 Following the agreement of the **Safety Precautions** in accordance with OC8B.8.1 the **Implementing Safety Co-ordinator** shall then establish the agreed **Isolation** and (if required) **Earthing**.

OC8B.8.2.2 The **Implementing Safety Co-ordinator** shall confirm to the **Requesting Safety Co-ordinator** that the agreed **Isolation** and (if required) **Earthing** has been established.

OC8B.8.2.3 The **Implementing Safety Co-ordinator** shall ensure that the established **Safety Precautions** are maintained until requested to be removed by the relevant **Requesting Safety Co-ordinator**.

OC8B.8.3 Permit for Work for proximity work Issue Procedure

OC8B.8.3.1 Where **Safety Precautions** on another **System(s)** are being provided to enable work to be carried out at a **User's Site** or **Transmission Site** (as the case may be) on equipment where the work or equipment is in proximity to **HV Apparatus** of the **Implementing Safety Co-ordinator**, before any work commences they must be recorded by a **Permit for Work for proximity work** being issued. The **Permit for Work for proximity work** shall identify the **Implementing Safety Co-ordinator's HV Apparatus** in proximity to the required work

OC8B.8.3.2 Once the **Safety Precautions** have been established (in accordance with OC8B.8.2), the **Implementing Safety Co-ordinator** shall agree to the issue of the **Permit for Work for proximity work** with the appropriately authorised site representative of the **Requesting Safety Co-ordinator's Site**. The **Implementing Safety Co-ordinator** will inform the **Requesting Safety Co-ordinator** of the **Permit for Work for proximity work** identifying number.

OC8B.8.3.3 The appropriately authorised site representative of the **Implementing Safety Co-ordinator** shall then issue the **Permit for Work for proximity work** to the appropriately authorised site representative of the **Requesting Safety Co-ordinator**. The **Permit for Work for proximity work** will in the section dealing with the work to be carried out, be completed to identify that the work is near the **Implementing Safety Co-ordinator's HV Apparatus**. No further details of the **Requesting Safety**

Co-ordinator's work will be recorded, as that is a matter for the **Requesting Safety Co-ordinator** in relation to his work.

OC8B.8.3.4 The **Requesting Safety Co-ordinator** is then free to authorise work in accordance with the requirements of the relevant internal safety procedures which apply to the **Requesting Safety Co-ordinator's Site**. This is likely to involve the issue of safety documents or other relevant internal authorisations.

OC8B.8.4 **Permit for Work for proximity work Cancellation Procedure**

OC8B.8.4.1 When the **Requesting Safety Co-ordinator** decides that **Safety Precautions** are no longer required, he will contact the relevant **Implementing Safety Co-ordinator** to effect cancellation of the associated **Permit for Work for proximity work**.

OC8B.8.4.2 The **Requesting Safety Co-ordinator** will inform the relevant **Implementing Safety Co-ordinator** of the **Permit for Work for proximity work** identifying number, and agree that the **Permit for Work for proximity work** can be cancelled. The cancellation is then effected by the appropriately authorised site representative of the **Requesting Safety Co-ordinator** returning the **Permit for Work for proximity work** to the appropriately authorised site representative of the **Implementing Safety Co-ordinator**.

OC8B.8.4.3 The **Implementing Safety Co-ordinator** is then free to arrange the removal of the **Safety Precautions**, the procedure to achieve that being entirely an internal matter for the party the **Implementing Safety Co-ordinator** is representing.

OC8B.9 **LOSS OF INTEGRITY OF SAFETY PRECAUTIONS**

OC8B.9.1 In any instance when any **Safety Precautions** may be ineffective for any reason the relevant **Safety Co-ordinator** shall inform the other **Safety Co-ordinator(s)** without delay of that being the case and, if requested, of the reasons why.

OC8B.10 **SAFETY LOG**

OC8B.10.1 **Relevant Transmission Licensees** and **Users** shall maintain **Safety Logs** which shall be a chronological record of all messages relating to safety co-ordination under **OC8** sent and received by the **Safety Co-ordinator(s)**. The **Safety Logs** must be retained for a period of not less than six years.

RECORD OF INTER-SYSTEM SAFETY PRECAUTIONS (RISSP-R)
(Requesting Safety Co-ordinator's Record)

RISSP NUMBER _____

Part 1

1.1 CIRCUIT IDENTIFICATION

Safety Precautions have been established by the Implementing Safety Co-ordinator to achieve Safety From The System on the following HV Apparatus:

1.2 SAFETY PRECAUTIONS ESTABLISHED

(a) ISOLATION

State the Locations(s) at which Isolation has been established on the Implementing Safety Co-ordinator's System. For each Location, identify each point of Isolation. For each point of Isolation state, the means by which the Isolation has been achieved, and whether, immobilised and Locked, Caution Notice affixed, other Safety Precautions applied, as appropriate.

(b) EARTHING

State the Locations(s) at which Earthing has been established on the Implementing Safety Co-ordinator's System. For each Location, identify each point of Earthing. For each point of Earthing state, the means by which the Earthing has been achieved, and whether, immobilised and Locked, other Safety Precautions applied, as appropriate.

1.3 ISSUE

I have received confirmation from _____ (name of Implementing Safety Co-ordinator) at _____ (Location) that the Safety Precautions identified in paragraph 1.2 have been established and that instructions will not be issued at his Location for their removal until this RISSP is cancelled.

Signed (Requesting Safety Co-ordinator)

at (time) on (date)

PART 2

2.1 CANCELLATION

I have confirmed to _____ (name of the Implementing Safety Co-ordinator) at _____ (Location) that the Safety Precautions set out in paragraph 1.2 are no longer required and accordingly the RISSP is cancelled.

Signed (Requesting Safety Co-ordinator)

at (time) on (date)

RECORD OF INTER-SYSTEM SAFETY PRECAUTIONS (RISSP-I)
(Implementing Safety Co-ordinator's Record)

RISSP NUMBER _____

PART 1

1.1 CIRCUIT IDENTIFICATION

Safety Precautions have been established by the Implementing Safety Co-ordinator to achieve Safety From The System on the following HV Apparatus:

1.2 SAFETY PRECAUTIONS ESTABLISHED

(a) ISOLATION

State the Location(s) at which isolation has been established on the Implementing Safety Co-ordinator's System. For each Location, identify each point of Isolation. For each point of Isolation state, the means by which the Isolation has been achieved, and whether, immobilised and Locked, Caution Notice affixed, other Safety Precautions applied, as appropriate.

(b) EARTHING

State the Location(s) at which Earthing has been established on the Implementing Safety Co-ordinator's System. For each Location, identify each point of Earthing. For each point of Earthing state, the means by which the Earthing has been achieved, and whether, immobilised and Locked, other Safety Precautions applied, as appropriate.

1.3 ISSUE

I confirmed to _____ (name of Requesting Safety Co-ordinator) at _____ (Location) that the Safety Precautions identified in paragraph 1.2 have been established and that instructions will not be issued at my Location for their removal until this RISSP is cancelled.

Signed (Implementing Safety Co-ordinator)
at (time) on (date)

PART 2

2.1 CANCELLATION

I have received confirmation from _____ (name of the Requesting Safety Co-ordinator) at _____ (Location) that the Safety Precautions set out in paragraph 1.2 are no longer required and accordingly the RISSP is cancelled.

Signed (Implementing Safety Co-ordinator)
at (time) on (date)

(Note: This form to be of a different colour from RISSP-R.)

RISSP ISSUE PROCESS

- OC8B -

Appendix C1

Requesting Safety Co-ordinator (RSC)

Person requiring **Safety Precaution** from another **User**

Implementing Safety Co-ordinator (ISC)

Person who co-ordinates provision of **Safety Precautions**

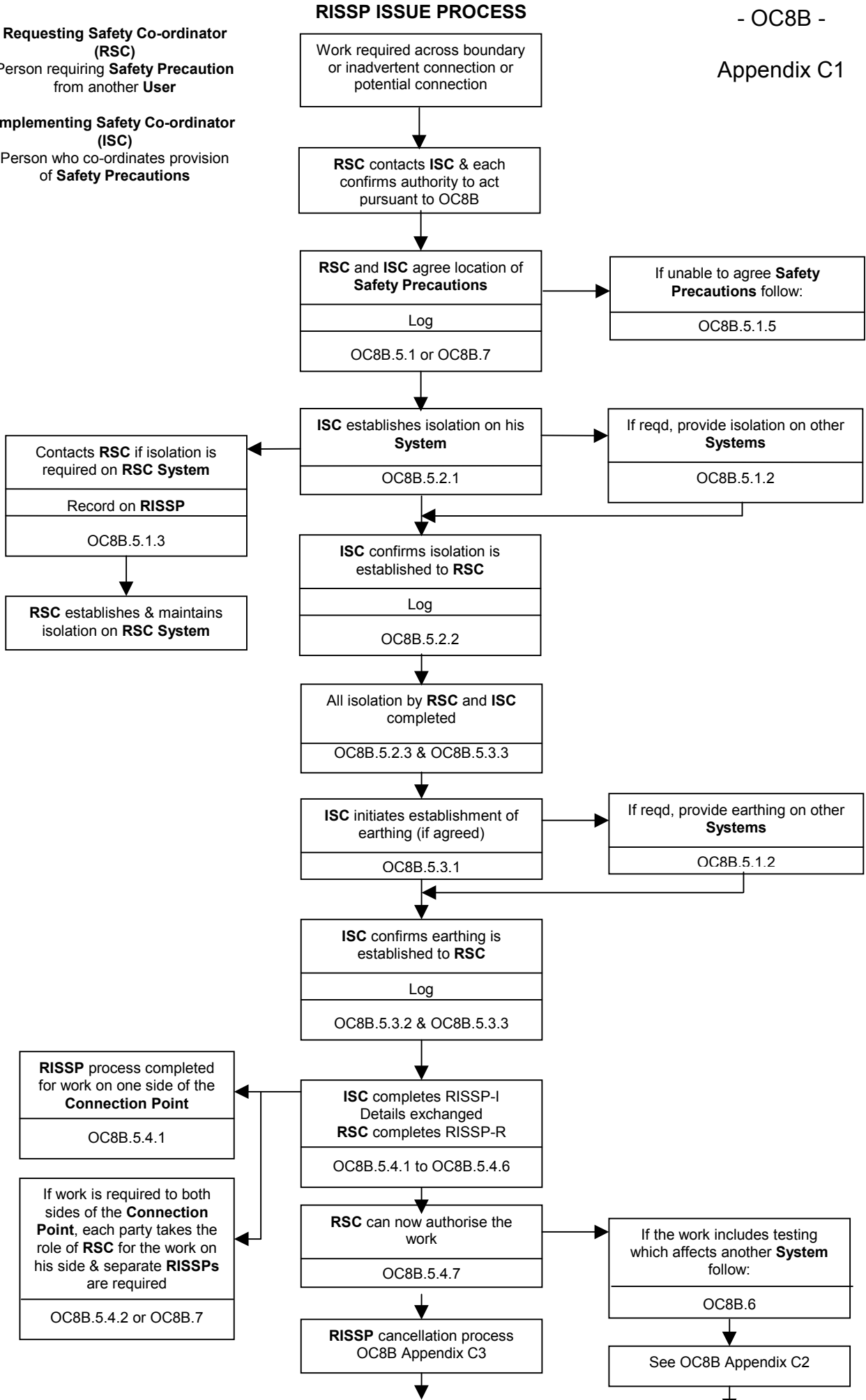

Where testing affects another Safety Co-ordinator's System

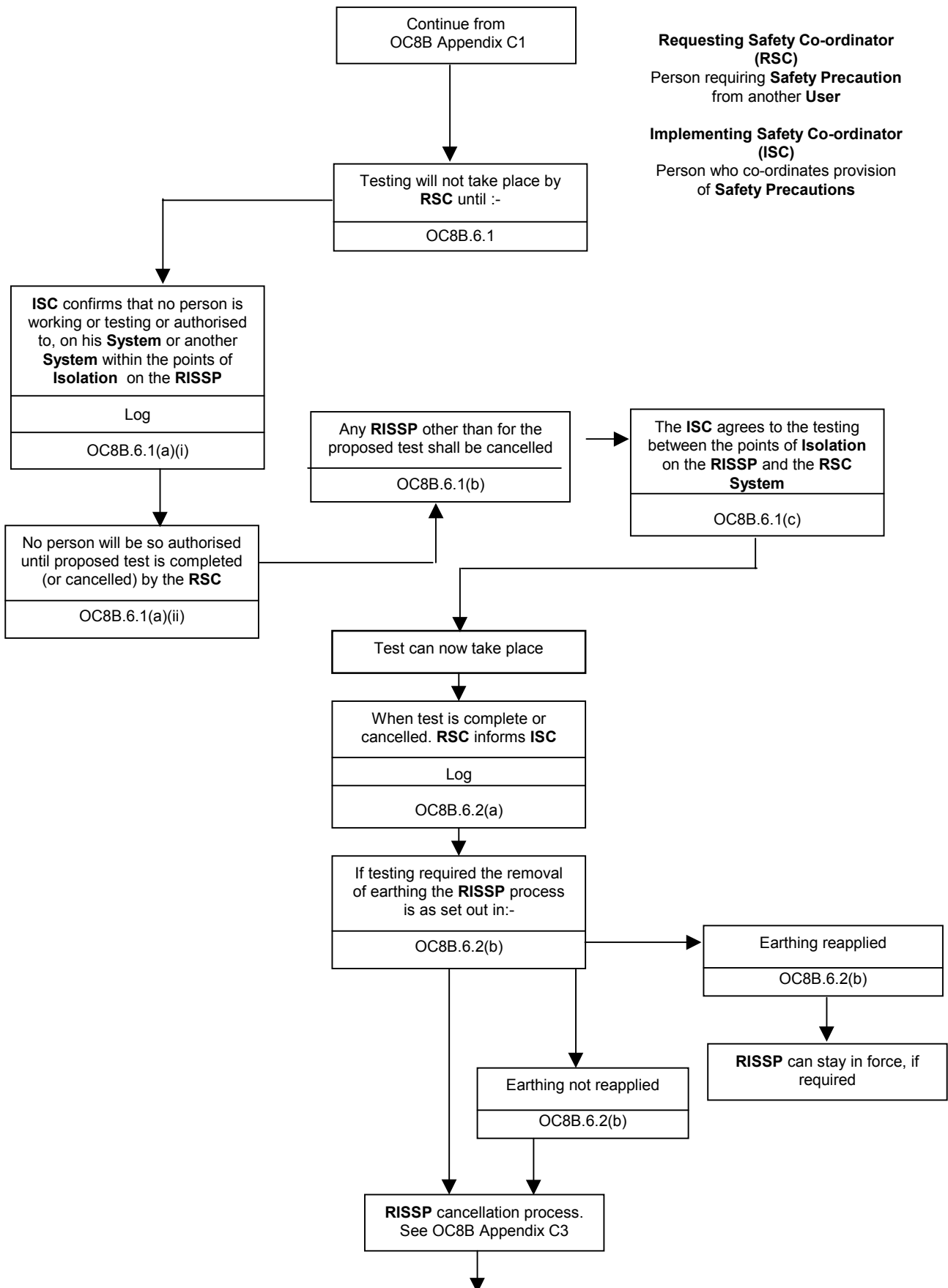

RISSP CANCELLATION PROCESS

- OC8B -

Appendix C3

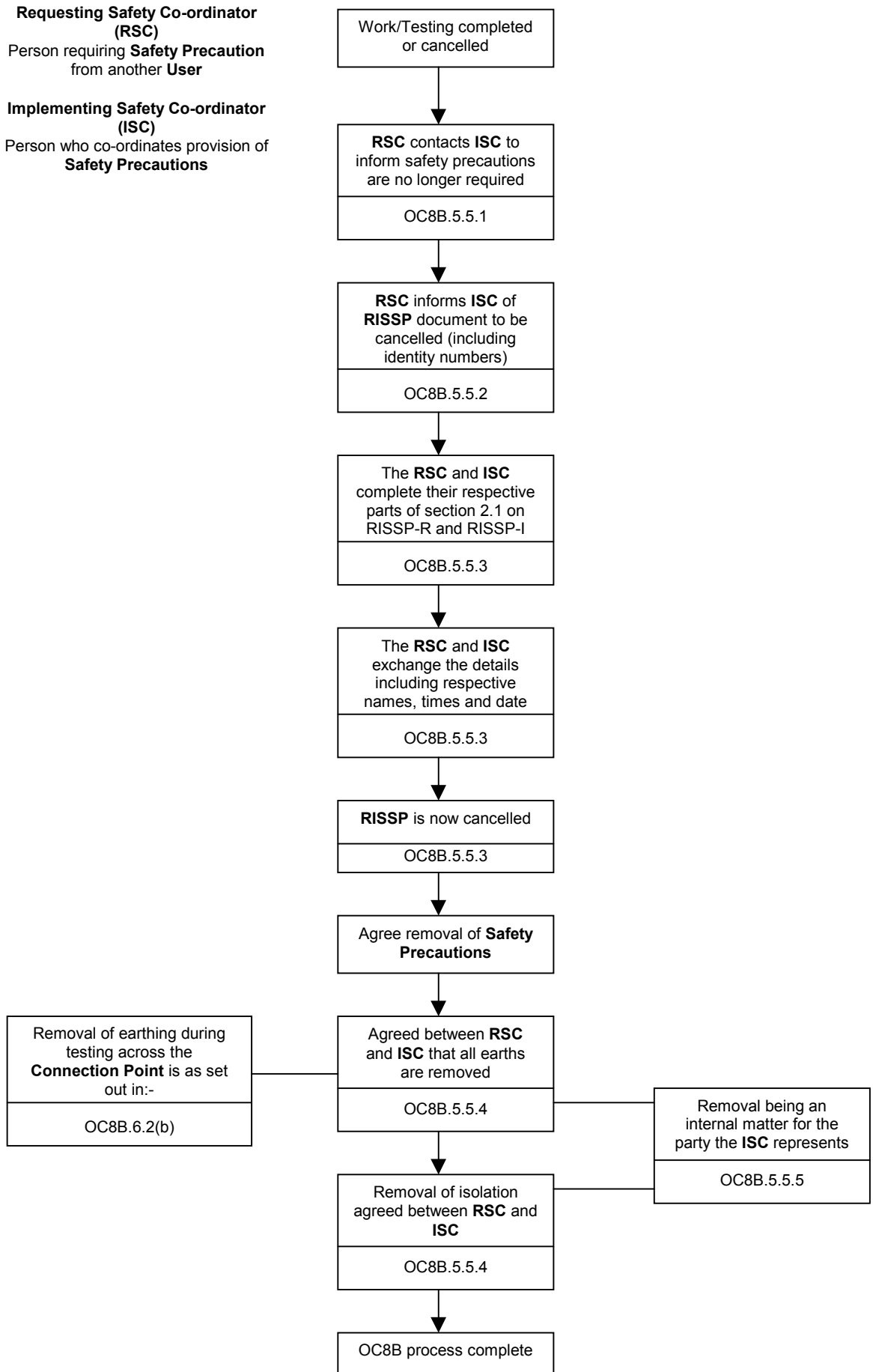

PROCESS FOR WORKING NEAR TO SYSTEM EQUIPMENT

- OC8B -

Appendix C4

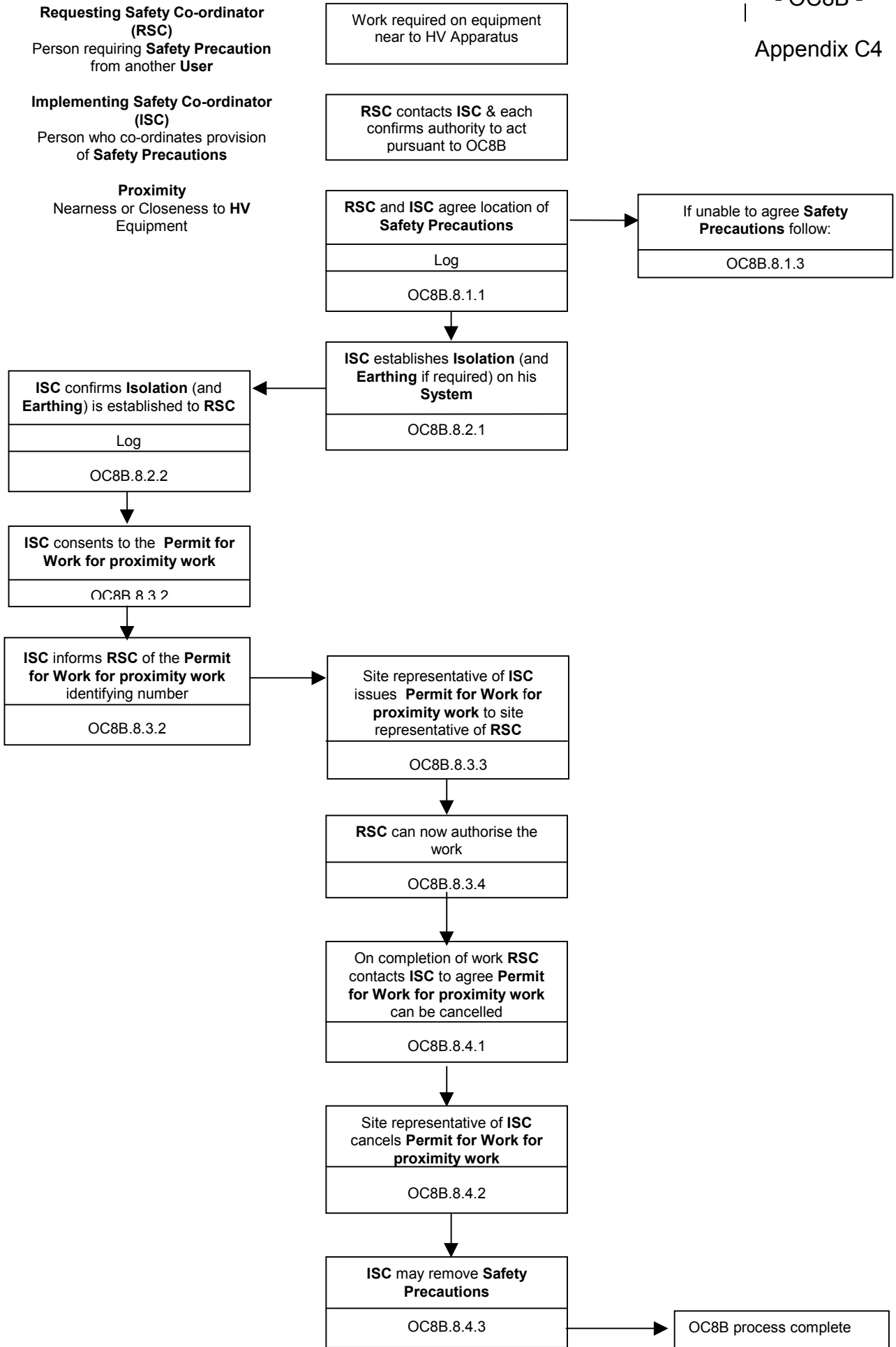

OC8B - Appendix D

Not Used

OC8B APPENDIX E

Scottish & Southern Energy plc

PERMIT-TO-WORK

No.

1. ISSUE

To

The following High Voltage Apparatus has been made safe in accordance with the Operational Safety Rules for the work detailed on this Permit-to-Work to proceed:

.....
.....
.....

TREAT ALL OTHER APPARATUS AS LIVE

Circuit Main Earths are applied at:

.....
.....
.....

Other precautions (see Operational Safety Rules 3.2.1(b), 4.6.2(c) and 5.5.3), and any special instructions:

.....
.....
.....

The following work is to be carried out:

.....
.....
.....

Circuit Identification Issued: Colour No. of wristlets No. of step bolts

Name: (print): Signature: Time: Date:

2. RECEIPT

I accept responsibility for carrying out the work on the Apparatus detailed on this Permit-to-Work, applying additional earths as necessary. No attempt will be made by me, or by the persons under my charge, to work on any other Apparatus.

Name: (print): Signature: Time: Date:

Circuit Identification Equipment Checked as above (Initials):

3. CLEARANCE

All persons under my control have been withdrawn and warned that it is no longer safe to work on the Apparatus detailed on this Permit-to-Work.

All gear, tools and additional earths have/have not* been removed. The works is/is not* complete.

All circuit identification equipment issued as above has been returned

Name: (print): Signature: Time: Date:

** Delete where not applicable*

4. CANCELLATION

This Permit-to-Work is cancelled.

Name: (print): Signature: Time: Date:

OC8B APPENDIX E

Scottish Power

PERMIT FOR WORK

No.
No.

KEY SAFE

- 1. (i) LOCATION
-
- (ii) PLANT/APPARATUS IDENTIFICATION
-
- (iii) WORK TO BE DONE
-
-
-

- 2. (i) PRECAUTIONS TAKEN TO ACHIEVE SAFETY FROM THE SYSTEM: State points at which **Plant/Apparatus** has been Isolated and specify position(s) of **Earthing Devices** applied. State actions taken to avoid **Danger** by draining, venting, purging and containment or dissipation of stored energy.
-
-
-
-
-
-
-
-
-
-

Caution Notices have been affixed to all points of isolation

- (ii) FURTHER PRECAUTIONS TO BE TAKEN DURING THE COURSE OF WORK TO AVOID SYSTEM DERIVED HAZARDS
-
-
-
-
-
-

I have confirmed with the **Control Person(s)*** that precautions in Section 2(i) have been carried out and that the **Control Person(s)** will maintain these until this **Permit for Work** is cancelled. I certify that the precautions in Section 2(i) together with the precautions in Section 2(ii) are adequate to provide **Safety from the System** in respect of the work in Section 1.

This **Permit for Work** must only be transferred under the **Personal Supervision** of a **Senior Authorised Person***

Signed being a **Senior Authorised Person**. Time: Date:

3. ISSUE

- (i) **Key Safe Key** (No.)* (ii) **Earthing Schedule*** (iii) **Portable Drain Earths** (No. off)*
- (iv) **Selected Person's Report** (No.)* (v) **Circuit Identification Flags** (No. off)*
- (vi) **Circuit Identification Wristlets** (No. off)* and Colours/Symbols

Signed being the **Senior Authorised Person** responsible
for the issue of this **Permit for Work** Time: Date:

4. RECEIPT

I understand and accept my responsibilities under the ScottishPower Safety Rules as recipient of this **Permit for Work** and acknowledge receipt of the items in Section 3.

Signed Name (Block Letters)
 being a **Competent Person** in the employ of Firm/Dept Time Date

TRANSFER RECORD

PART 1		PART 2	PART 3			
Person surrendering Document	Time Date	Senior Authorised Person receiving suspended Document *	†Person receiving reissued Document		Senior Authorised Person reissuing document	Time Date
			Signature	Name (Block Letters)		
		X				

†Signature of **Person** receiving re-issued Document in accordance with conditions detailed in Section 4.

5. CLEARANCE: I certify that all persons working under this **Permit for Work** have been withdrawn from, and warned not to work on, the **Plant/Apparatus** in Section 1. All gears, tools, **Drain Earths** and loose material have been removed and guards and access doors have been replaced, except for:

.....

Signed being the **Competent Person** responsible for
 clearing this **Permit for Work** Time Date

6. CANCELLATION: I certify that all items issued under Section 3 have been accounted for and the **Control Person(s)*** informed of the cancellation and of any restrictions on returning the **Plant/Apparatus** to service.

Signed being the **Senior Authorised Person** responsible for
 cancelling this **Permit for Work**. Time Date

*N/A if Not Applicable

< End of OC8B >

< End of OC8 >

OPERATING CODE NO.9
CONTINGENCY PLANNING
CONTENTS

(This contents page does not form part of the Grid Code)

<u>Paragraph No/Title</u>	<u>Page Number</u>
OC9.1 INTRODUCTION	1
OC9.1.1 Black Starts.....	1
OC9.1.2 Re-Synchronisation of Islands.....	1
OC9.1.3 Joint System Incident Procedure.....	1
OC9.2 OBJECTIVE.....	1
OC9.3 SCOPE.....	2
OC9.4 BLACK START	2
OC9.4.1 Total Shutdown	2
OC9.4.2 Partial Shutdown	2
OC9.4.5 Black Start Stations.....	3
OC9.4.6 Black Start Situation	3
OC9.4.7 Black Start.....	3
NGET Instructions	4
Embedded Power Stations	5
Local Joint Restoration Plan operation	5
Interconnection of Power Islands.....	6
Conclusion of Black Start.....	6
Externally Interconnected Parties	6
Local Joint Restoration Plan establishment	7
OC9.5 RE-SYNCHRONISATION OF DE-SYNCHRONISED ISLANDS.....	9
OC9.5.2 Options.....	10
OC9.5.2.1 Indirect Data.....	10
OC9.5.2.2 Direct Data	10
OC9.5.2.3 Control Features	11
OC9.5.2.4 Absence of Control Features System.....	11
OC9.5.3 Choice of Option	11
OC9.5.4 Agreeing Procedures.....	12
OC9.6 JOINT SYSTEM INCIDENT PROCEDURE	14

OPERATING CODE NO.9

CONTINGENCY PLANNING

OC9.1 INTRODUCTION

Operating Code No.9 ("OC9") covers the following:

OC9.1.1 Black Starts

The implementation of recovery procedures following a **Total Shutdown** or **Partial Shutdown**.

OC9.1.2 Re-Synchronisation of Islands

The **Re-Synchronisation** of parts of the **Total System** which have become **Out of Synchronism** with each other but where there is no **Total Shutdown** or **Partial Shutdown**.

OC9.1.3 Joint System Incident Procedure

The establishment of a communication route and arrangements between senior management representatives of **NGET** and **Users** involved in, or who may be involved in, an actual or potential serious or widespread disruption to the **Total System** or a part of the **Total System**, which requires, or may require, urgent managerial response, day or night, but which does not fall within the provisions of OC9.1.4.

OC9.1.4 It should be noted that under section 96 of the **Act** the **Secretary of State** may give directions to **NGET** and/or any **Generator** and/or any **Supplier**, for the purpose of "mitigating the effects of any civil emergency which may occur" (ie. for the purposes of planning for a civil emergency); a civil emergency is defined in the **Act** as "any natural disaster or other emergency which, in the opinion of the **Secretary of State**, is or may be likely to disrupt electricity supplies". Under the Energy Act 1976, the **Secretary of State** has powers to make orders and give directions controlling the production, supply, acquisition or use of electricity, where an Order in Council under section 3 is in force declaring that there is an actual or imminent emergency affecting electricity supplies. In the event that any such directions are given, or orders made under the **Energy Act 1976**, the provisions of the **Grid Code** will be suspended in so far as they are inconsistent with them.

OC9.1.5 **NGET** shall procure that **Relevant Transmission Licensees** shall comply with OC9.4 and OC9.5 and any relevant **Local Joint Restoration Plan** or **OC9 De-Synchronised Island Procedure** where and to the extent that such matters apply to them.

OC9.2 OBJECTIVE

The overall objectives of **OC9** are:

OC9.2.1 To achieve, as far as possible, restoration of the **Total System** and associated **Demand** in the shortest possible time, taking into account **Power Station** capabilities, including **Embedded Generating Units**, **External Interconnections** and the operational constraints of the **Total System**.

OC9.2.2 To achieve the **Re-Synchronisation** of parts of the **Total System** which have become **Out of Synchronism** with each other.

OC9.2.3 To ensure that communication routes and arrangements are available to enable senior management representatives of **NGET** and **Users**, who are authorised to make binding decisions on behalf of **NGET** or the relevant **User**, as the case may be, to communicate with each other in the situation described in OC9.1.3.

OC9.2.4 To describe the role that in Scotland a **Relevant Transmission Licensee** may have in the restoration processes as detailed in the relevant **OC9 De-Synchronised Island Procedures** and **Local Joint Restoration Plans**.

OC9.3 SCOPE

OC9.3.1 **OC9** applies to **NGET** and to **Users**, which in **OC9** means:-

- (a) **Generators;**
- (b) **Network Operators;** and
- (c) **Non-Embedded Customers.**

OC9.3.2 The procedure for the establishment of emergency support/contingency planning between **NGET** and **Externally Interconnected System Operators** is set out in the **Interconnection Agreement** with each **Externally Interconnected System Operator**.

OC9.3.3 In Scotland, OC9.4 and OC9.5 also apply to **Relevant Transmission Licensees**.

OC9.4 BLACK START

OC9.4.1 Total Shutdown

A "**Total Shutdown**" is the situation existing when all generation has ceased and there is no electricity supply from **External Interconnections**. Therefore, the **Total System** has shutdown with the result that it is not possible for the **Total System** to begin to function again without **NGET's** directions relating to a **Black Start**.

OC9.4.2 Partial Shutdown

A "**Partial Shutdown**" is the same as a **Total Shutdown** except that all generation has ceased in a separate part of the **Total System** and there is no electricity supply from **External Interconnections** or other parts of the **Total System** to that part of the **Total System**. Therefore, that part of the **Total System** is shutdown with the result that it is not possible for that part of the **Total System** to begin to function again without **NGET's** directions relating to a **Black Start**.

OC9.4.3 During a **Total Shutdown** or **Partial Shutdown** and during the subsequent recovery, the **Licence Standards** may not apply and the **Total System** may be operated outside normal voltage and **Frequency** standards.

OC9.4.4 In a **Total Shutdown** and in a **Partial Shutdown**, it may be necessary for **NGET** to issue **Emergency Instructions** in accordance with BC2.9 and it may be necessary to depart from normal **Balancing Mechanism** operation in accordance with **BC2** in issuing **Bid-Offer Acceptances**.

OC9.4.5 **Black Start Stations**

OC9.4.5.1 Certain **Power Stations** ("**Black Start Stations**") are registered, pursuant to the **Bilateral Agreement** with a **User**, as having an ability for at least one of its **Gensets** to **Start-Up** from **Shutdown** and to energise a part of the **Total System**, or be **Synchronised** to the **System**, upon instruction from **NGET** within two hours, without an external electrical power supply ("**Black Start Capability**").

OC9.4.5.2 For each **Black Start Station**, a **Local Joint Restoration Plan** will be produced jointly by **NGET**, the relevant **Generator** and **Network Operator** in accordance with the provisions of OC9.4.7.11. The **Local Joint Restoration Plan** will detail the agreed method and procedure by which a **Genset** at a **Black Start Station** (possibly with other **Gensets** at that **Black Start Station**) will energise part of the **Total System** and meet complementary local **Demand** so as to form a **Power Island**.

OC9.4.5.3 In Scotland, a **Local Joint Restoration Plan** may cover more than one **Black Start Station** and may be produced with and include obligations on **Relevant Transmission Licensees, Generators** responsible for **Gensets** not at a **Black Start Station** and other **Users**.

OC9.4.6 **Black Start Situation**

In the event of a **Total Shutdown** or **Partial Shutdown**, **NGET** will, as soon as reasonably practical, inform **Users** (or, in the case of a **Partial Shutdown**, **Users** which in **NGET's** opinion need to be informed) that a **Total Shutdown**, or, as the case may be, a **Partial Shutdown**, exists and that **NGET** intends to implement a **Black Start**.

In Scotland, in exceptional circumstances, as specified in the **Local Joint Restoration Plan**, the **Relevant Transmission Licensee**, may invoke such **Local Joint Restoration Plan** for its own **Transmission System** and operate within its provisions.

OC9.4.7 **Black Start**

OC9.4.7.1 The procedure necessary for a recovery from a **Total Shutdown** or **Partial Shutdown** is known as a "**Black Start**". The procedure for a **Partial Shutdown** is the same as that for a **Total Shutdown** except that it applies only to a part of the **Total System**. It should be remembered that a **Partial Shutdown** may affect parts of the **Total System** which are not themselves shutdown.

OC9.4.7.2 The complexities and uncertainties of recovery from a **Total Shutdown** or **Partial Shutdown** require that **OC9** is sufficiently flexible in order to accommodate the full range of **Genset** and **Total System** characteristics and operational possibilities, and this precludes the setting out in the **Grid Code** itself of concise chronological sequences. The overall strategy will, in general, include the overlapping phases of establishment of **Genset(s)** at an isolated **Power Station**, together with complementary local **Demand**, termed "**Power Islands**", step by

step integration of these **Power Islands** into larger sub-systems and eventually re-establishment of the complete **Total System**.

NGET Instructions

OC9.4.7.3 The procedures for a **Black Start** will, therefore, be those specified by **NGET** at the time. These will normally recognise any applicable **Local Joint Restoration Plan**. **Users** shall abide by **NGET's** instructions during a **Black Start** situation, even if these conflict with the general overall strategy outlined in OC9.4.7.2 or any applicable **Local Joint Restoration Plan**. **NGET's** instructions may (although this list should not be regarded as exhaustive) be to a **Black Start Station** relating to the commencement of generation, to a **Network Operator** or **Non-Embedded Customer** relating to the restoration of **Demand**, and to a **Power Station** relating to preparation for commencement of generation when an external power supply is made available to it, and in each case may include the requirement to undertake switching.

In Scotland the **Relevant Transmission Licensee** will act on **NGET's** behalf in accordance with its duties under the relevant **Local Joint Restoration Plan**. **Users** shall abide by the **Relevant Transmission Licensee's** instructions given in accordance with the **Local Joint Restoration Plan** during a **Black Start** situation.

OC9.4.7.4 (a) During a **Black Start** situation, instructions in relation to **Black Start Stations** will be in the format required for **Emergency Instructions** in **BC2**, and will recognise any differing **Black Start** operational capabilities (however termed) set out in the relevant **Ancillary Services Agreement** in preference to the declared operational capability as registered pursuant to **BC1** (or as amended from time to time in accordance with the **BCs**). For the purposes of these instructions the **Black Start** will be an emergency circumstance under BC2.9.

In Scotland, **Gensets** that are not at **Black Start Stations**, but which are part of a **Local Joint Restoration Plan**, may be instructed in accordance with the provisions of that **Local Joint Restoration Plan**.

For **Power Stations** which are not part of a **Local Joint Restoration Plan**, **Bid-Offer Acceptances** will recognise each **BM Unit's Export and Import Limits** and **Dynamic Parameters** as submitted pursuant to **BC1** or **BC2** (or as amended from time to time in accordance with the **BCs**).

(b) If during the **Demand** restoration process any **Genset** cannot, because of the **Demand** being experienced, keep within its safe operating parameters, the **Generator** shall, unless a **Local Joint Restoration Plan** is in operation, inform **NGET**. **NGET** will, where possible, either instruct **Demand** to be altered or will re-configure the **GB Transmission System** or will instruct a **User** to re-configure its **System** in order to alleviate the problem being experienced by the **Generator**. If a **Local Joint Restoration Plan** is in operation, then the arrangements set out therein shall apply. However, **NGET** accepts that any decision to keep a **Genset** operating, if outside its safe operating parameters, is one for the **Generator** concerned alone and accepts that the **Generator** may change generation on that **Genset** if it believes it is necessary for safety reasons (whether relating to personnel or **Plant** and/or **Apparatus**). If such a change is made without prior notice, then the **Generator** shall inform **NGET**

as soon as reasonably practical (unless a **Local Joint Restoration Plan** is in operation in which case the arrangements set out therein shall apply).

Embedded Power Stations

OC9.4.7.5 Without prejudice to the provisions of OC9.4.7.8, **Network Operators with Embedded Power Stations** will comply with any directions of **NGET** to restore **Demand** to be met by the **Embedded Power Stations**.

Local Joint Restoration Plan operation

- OC9.4.7.6
- (a) The following provisions apply in relation to a **Local Joint Restoration Plan**. As set out in OC9.4.7.3, **NGET** may issue instructions which conflict with a **Local Joint Restoration Plan**. In such cases, these instructions will take precedence over the requirements of the **Local Joint Restoration Plan**. When issuing such instructions, **NGET** shall state whether or not it wishes the remainder of the **Local Joint Restoration Plan** to apply. If, notwithstanding that **NGET** has stated that it wishes the remainder of the **Local Joint Restoration Plan** to apply, the **Generator** or the relevant **Network Operator** consider that **NGET's** instructions mean that it is not possible to operate the **Local Joint Restoration Plan** as modified by those instructions, any of them may give notice to **NGET** and the other parties to the **Local Joint Restoration Plan** to this effect and **NGET** shall immediately consult with all parties to the **Local Joint Restoration Plan**. Unless all parties to the **Local Joint Restoration Plan** reach an agreement forthwith as to how the **Local Joint Restoration Plan** shall operate in those circumstances, operation in accordance with the **Local Joint Restoration Plan** will terminate.
 - (b) Where **NGET**, as part of a **Black Start**, has given an instruction to a **Black Start Station** to initiate **Start-Up**, the relevant **Genset(s)** at the **Black Start Station** will **Start-Up** in accordance with the **Local Joint Restoration Plan**.
 - (c) **NGET** will advise the relevant **Network Operator** of the requirement to switch its **User System** so as to segregate its **Demand** and to carry out such other actions as set out in the **Local Joint Restoration Plan**. The relevant **Network Operator** will then operate in accordance with the provisions of the **Local Joint Restoration Plan**.
 - (d) **NGET** will ensure that switching carried out on the **GB Transmission System** and other actions are as set out in the **Local Joint Restoration Plan**.
 - (e) Following notification from the **Generator** that the **Black Start Station** is ready to accept load, **NGET** will instruct the **Black Start Station** to energise part of the **Total System**. The **Black Start Station** and the relevant **Network Operator** will then, in accordance with the requirements of the **Local Joint Restoration Plan**, establish communication and agree the output of the relevant **Genset(s)** and the connection of **Demand** so as to establish a **Power Island**. During this period, the **Generator** will be required to regulate the output of the relevant **Genset(s)** at its **Black Start Station** to the **Demand** prevailing in the **Power Island** in which it is situated, on the basis that it will (where practicable) seek to maintain the **Target Frequency**. The **Genset(s)** at the **Black Start Station** will (where

practical) also seek to follow the requirements relating to **Reactive Power** (which may include the requirement to maintain a target voltage) set out in the **Local Joint Restoration Plan**.

- (f) Operation in accordance with the **Local Joint Restoration Plan** will be terminated by **NGET** (by notifying the relevant **Users**) prior to connecting the **Power Island** to other **Power Islands** (other than, in Scotland, as allowed for in the **Local Joint Restoration Plan**), or to the **User System** of another **Network Operator**, or to the synchronising of **Gensets** at other **Power Stations** (other than, in Scotland, those forming part of the **Local Joint Restoration Plan**). Operation in accordance with the **Local Joint Restoration Plan** will also terminate in the circumstances provided for in OC9.4.7.6(a) if an agreement is not reached or if **NGET** states that it does not wish the remainder of the **Local Joint Restoration Plan** to apply. **Users** will then comply with the **Bid-Offer Acceptances** or **Emergency Instructions** of **NGET**.
- (g) In Scotland, **Gensets** included in a **Local Joint Restoration Plan**, but not at a **Black Start Station**, will operate in accordance with the requirements of the **Local Joint Restoration Plan**.

Interconnection of Power Islands

OC9.4.7.7 **NGET** will instruct the relevant **Users** so as to interconnect **Power Islands** to achieve larger sub-systems, and subsequently the interconnection of these sub-systems to form an integrated system. This should eventually achieve the re-establishment of the **Total System** or that part of the **Total System** subject to the **Partial Shutdown**, as the case may be.

OC9.4.7.8 As part of the **Black Start** strategy each **Network Operator** with either an **Embedded Black Start Station** which has established a **Power Island** within its **User System** or with any **Embedded Power Stations** within its **User System** which have become islanded, may in liaison with **NGET** sustain and expand these islands in accordance with the relevant provisions of OC9.5 which shall apply to this OC9.4 as if set out here. They will inform **NGET** of their actions and will not **Re-Synchronise** to the **GB Transmission System** or any **User's System** which is already **Synchronised** to the **GB Transmission System** without **NGET's** agreement.

Conclusion of Black Start

OC9.4.7.9 The conclusion of the **Black Start**, and the time of the return to normal operation of the **Total System**, will be determined by **NGET** who shall inform **Users** (or where there has been a **Partial Shutdown**, **Users** which in **NGET's** opinion need to be informed) that the **Black Start** situation no longer exists and that normal operation of the **Total System** has begun.

Externally Interconnected System Operators

OC9.4.7.10 During a **Black Start**, **NGET** will, pursuant to the **Interconnection Agreement** with **Externally Interconnected System Operators**, agree with **Externally Interconnected System Operators** when their transmission systems can be **Re-Synchronised** to the **Total System**, if they have become separated.

OC9.4.7.11 Local Joint Restoration Plan establishment

- (a) In England and Wales, in relation to each **Black Start Station, NGET, the Network Operator** and the relevant **Generator** will discuss and agree a **Local Joint Restoration Plan**. Where at the date of the first inclusion of this OC9.4.7.11 into the **Grid Code** a local plan covering the procedures to be covered in a **Local Joint Restoration Plan** is in existence and agreed, **NGET** will discuss this with the **Network Operator** and the relevant **Generator** to agree whether it is consistent with the principles set out in this OC9.4. If it is agreed to be so consistent, then it shall become a **Local Joint Restoration Plan** under this OC9 and the relevant provisions of OC9.4.7.11(b) shall apply. If it is not agreed to be so consistent, then the provisions of OC9.4.7.11(b) shall apply as if there is no **Local Joint Restoration Plan** in place.

In Scotland where a requirement for a **Local Joint Restoration Plan** is identified, **NGET, the Relevant Transmission Licensee, the Network Operator** and **Black Start Station(s)** will discuss and agree a **Local Joint Restoration Plan**. In addition other **Users, including other Generators,** may be reasonably required by **NGET** to discuss and agree a **Local Joint Restoration Plan**.

- (b) In England and Wales, where the need for a **Local Joint Restoration Plan** arises when there is none in place, the following provisions shall apply:-
- (i) **NGET, the Network Operator** and the relevant **Generator** will discuss and agree the detail of the **Local Joint Restoration Plan** as soon as the requirement for a **Local Joint Restoration Plan** is identified by **NGET**. **NGET** will notify all affected **Users,** and will initiate these discussions.
 - (ii) Each **Local Joint Restoration Plan** will be in relation to a specific **Black Start Station**.
 - (iii) The **Local Joint Restoration Plan** will record which **Users** and which **User Sites** are covered by the **Local Joint Restoration Plan** and set out what is required from **NGET** and each **User** should a **Black Start** situation arise.
 - (iv) Each **Local Joint Restoration Plan** shall be prepared by **NGET** to reflect the above discussions and agreement.
 - (v) Each page of the **Local Joint Restoration Plan** shall bear a date of issue and the issue number.
 - (vi) When a **Local Joint Restoration Plan** has been prepared, it shall be sent by **NGET** to the **Users** involved for confirmation of its accuracy.
 - (vii) The **Local Joint Restoration Plan** shall then (if its accuracy has been confirmed) be signed on behalf of **NGET** and on behalf of each relevant **User** by way of written confirmation of its accuracy.

- (viii) Once agreed under this OC9.4.7.11, the procedure will become a **Local Joint Restoration Plan** under the **Grid Code** and (subject to any change pursuant to this OC9) will apply between **NGET** and the relevant **Users** as if it were part of the **Grid Code**.
 - (ix) Once signed, a copy of the **Local Joint Restoration Plan** will be distributed by **NGET** to each **User** which is a party to it accompanied by a note indicating the date of implementation.
 - (x) **NGET** and **Users** must make the **Local Joint Restoration Plan** readily available to the relevant operational staff.
 - (xi) If **NGET**, or any **User** which is a party to a **Local Joint Restoration Plan**, becomes aware that a change is needed to that **Local Joint Restoration Plan**, it shall (in the case of **NGET**) initiate a discussion between **NGET** and the relevant **Users** to seek to agree the relevant change. If a **User** becomes so aware, it shall contact **NGET** who will then initiate such discussions. The principles applying to establishing a new **Local Joint Restoration Plan** under this OC9.4.7.11 shall apply to such discussions and to any consequent changes.
- (c) In Scotland, where the need for a **Local Joint Restoration Plan** arises, the following provisions shall apply:-
- (i) **NGET**, the **Relevant Transmission Licensee**, the **Network Operator** and the relevant **Generator** will discuss and agree the detail of the **Local Joint Restoration Plan** as soon as the requirement for a **Local Joint Restoration Plan** is identified by **NGET**. In addition other **Users**, including other **Generators**, may be reasonably required by **NGET** to discuss and agree details of the **Local Joint Restoration Plan** as soon as the requirement for a **Local Joint Restoration Plan** is identified by **NGET**. **NGET** will notify the **Relevant Transmission Licensee** and all affected **Users**, and will initiate these discussions.
 - (ii) Each **Local Joint Restoration Plan** may be in relation to either a specific **Black Start Station** or a number of **Black Start Stations**, and may include **Gensets** at **Power Stations** other than a **Black Start Station**.
 - (iii) The **Local Joint Restoration Plan** will record which **Users** and which **User Sites** are covered by the **Local Joint Restoration Plan** and set out what is required from **NGET**, the **Relevant Transmission Licensee** and each **User** should a **Black Start** situation arise.
 - (iv) Each **Local Joint Restoration Plan** shall be prepared by **NGET** to reflect the above discussions and agreement.
 - (v) Each page of the **Local Joint Restoration Plan** shall bear a date of issue and the issue number.
 - (vi) When a **Local Joint Restoration Plan** has been prepared, it shall be sent by **NGET** to the **Relevant Transmission Licensee** and **Users** involved for confirmation of its accuracy.

- (vii) The **Local Joint Restoration Plan** shall then (if its accuracy has been confirmed) be signed on behalf of **NGET** and on behalf of each relevant **User** and **Relevant Transmission Licensee** by way of written confirmation of its accuracy.
- (viii) Once agreed under this OC9.4.7.11, the procedure will become a **Local Joint Restoration Plan** under the **Grid Code** and (subject to any change pursuant to this **OC9**) will apply between **NGET**, **Relevant Transmission Licensee** and the relevant **Users** as if it were part of the **Grid Code**.
- (ix) Once signed, a copy of the **Local Joint Restoration Plan** will be distributed by **NGET** to the **Relevant Transmission Licensee** and each **User** which is a party to it accompanied by a note indicating the date of implementation.
- (x) **NGET**, the **Relevant Transmission Licensee** and **Users** must make the **Local Joint Restoration Plan** readily available to the relevant operational staff.
- (xi) If **NGET**, the **Relevant Transmission Licensee** or any **User** which is a party to a **Local Joint Restoration Plan**, becomes aware that a change is needed to that **Local Joint Restoration Plan**, it shall (in the case of **NGET**) initiate a discussion between **NGET**, the **Relevant Transmission Licensee** and the relevant **Users** to seek to agree the relevant change. If a **User** or the **Relevant Transmission Licensee** becomes so aware, it shall contact **NGET** who will then initiate such discussions. The principles applying to establishing a new **Local Joint Restoration Plan** under this OC9.4.7.11 shall apply to such discussions and to any consequent changes.

OC9.5

RE-SYNCHRONISATION OF DE-SYNCHRONISED ISLANDS

The provisions in this OC9.5 do not apply to the parts of the **Total System** that normally operate **Out of Synchronism** with the rest of the **GB Transmission System**.

OC9.5.1

- (a) Where parts of the **Total System** are **Out of Synchronism** with each other (each such part being termed a "**De-Synchronised Island**"), but there is no **Total Shutdown** or **Partial Shutdown**, **NGET** will instruct **Users** to regulate generation or **Demand**, as the case may be, to enable the **De-Synchronised Islands** to be **Re-Synchronised** and **NGET** will inform those **Users** when **Re-Synchronisation** has taken place.
- (b) As part of that process, there may be a need to deal specifically with **Embedded** generation in those **De-Synchronised Islands**. This OC9.5 provides for how such **Embedded** generation should be dealt with. In Scotland, this OC9.5 also provides for how **Transmission** connected generation in **De-Synchronised Islands** should be dealt with.
- (c) In accordance with the provisions of the **BCs**, **NGET** may decide that, to enable **Re-Synchronisation**, it will issue **Emergency Instructions** in accordance with BC2.9 and it may be necessary to depart from normal

Balancing Mechanism operation in accordance with **BC2** in issuing **Bid-Offer Acceptances**.

- (d) The provisions of this OC9.5 shall also apply to the **Re-Synchronising** of parts of the **System** following a **Total** or **Partial Shutdown**, as indicated in OC9.4.

OC9.5.2 Options

Generation in those **De-Synchronised Islands** may be dealt with in three different ways, more than one of which may be utilised in relation to any particular incident:-

OC9.5.2.1 Indirect Data

- (a) **NGET**, each **Generator** with **Synchronised** (or connected and available to generate although not **Synchronised**) **Genset(s)** in the **De-Synchronised Island** and the **Network Operator** whose **User System** forms all or part of the **De-Synchronised Island** shall exchange information as set out in this OC9.5.2.1 to enable **NGET** to issue a **Bid-Offer Acceptance** or an **Emergency Instruction** to that **Generator** in relation to its **Genset(s)** in the **De-Synchronised Island** until **Re-Synchronisation** takes place, on the basis that it will (where practicable) seek to maintain the **Target Frequency**.
- (b) The information to **NGET** from the **Generator** will cover its relevant operational parameters as outlined in the **BCs** and from **NGET** to the **Generator** will cover data on **Demand** and changes in **Demand** in the **De-Synchronised Island**.
- (c) The information from the **Network Operator** to **NGET** will comprise data on **Demand** in the **De-Synchronised Island**, including data on any constraints within the **De-Synchronised Island**.
- (d) **NGET** will keep the **Network Operator** informed of the **Bid-Offer Acceptances** or **Emergency Instructions** it is issuing to **Embedded Genset(s)** within the **Network Operator's User System** forming part of the **De-Synchronised Island**.

OC9.5.2.2 Direct Data

- (a) **NGET** will issue an **Emergency Instruction** and/or a **Bid-Offer Acceptance**, to the **Generator** to "float" local **Demand** and maintain **Frequency** at **Target Frequency**. Under this the **Generator** will be required to regulate the output of its **Genset(s)** at the **Power Station** in question to the **Demand** prevailing in the **De-Synchronised Island** in which it is situated, until **Re-Synchronisation** takes place, on the basis that it will (where practicable) seek to maintain the **Target Frequency**.
- (b) The **Network Operator** is required to be in contact with the **Generator** at the **Power Station** to supply data on **Demand** changes within the **De-Synchronised Island**.
- (c) If more than one **Genset** is **Synchronised** on the **De-Synchronised Island**, or is connected to the **De-Synchronised Island** and available to

generate although not **Synchronised**, the **Network Operator** will need to liaise with **NGET** to agree which **Genset(s)** will be utilised to accommodate changes in **Demand** in the **De-Synchronised Island**. The **Network Operator** will then maintain contact with the relevant **Generator** (or **Generators**) in relation to that **Genset(s)**.

- (d) The **Generator** at the **Power Station** must contact the **Network Operator** if the level of **Demand** which it has been asked to meet as a result of the **Emergency Instruction** and/or **Bid-Offer Acceptance** to "float" and the detail on **Demand** passed on by the **Network Operator**, is likely to cause problems for safety reasons (whether relating to personnel or **Plant** and/or **Apparatus**) in the operation of its **Genset(s)**, in order that the **Network Operator** can alter the level of **Demand** which that **Generator** needs to meet. Any decision to operate outside any relevant parameters is one entirely for the **Generator**.

OC9.5.2.3 Control Features

- (a) A system may be established in relation to a part of the **GB Transmission System** and a **Network Operator's User System**, if agreed between **NGET** and the **Network Operator** and any relevant **Generator(s)**, whereby upon a defined fault(s) occurring, manual or automatic control features will operate to protect the **GB Transmission System** and relevant **Network Operator's User System** and **Genset(s)** and simplify the restoration of **Demand** in the **De-Synchronised Island**.
- (b) In agreeing the establishment of such a system of control features **NGET** will need to consider its impact on the operation of the **GB Transmission System**.

OC9.5.2.4 Absence of Control Features System

If a system of control features under OC9.5.2.3 has not been agreed as part of an **OC9 De-Synchronised Island Procedure** under OC9.5.4 below, **NGET** may choose to utilise the procedures set out in OC9.5.2.1 or OC9.5.2.2, or may instruct the **Genset(s)** (or some of them) in the **De-Synchronised Island** to **De-Synchronise**.

OC9.5.3 Choice of Option

In relation to each of the methods set out in OC9.5.2, where a **De-Synchronised Island** has come into existence and where an **OC9 De-Synchronised Island Procedure** under OC9.5.4 has been agreed, **NGET**, the **Network Operator** and relevant **Generator(s)** will operate in accordance with that **OC9 De-Synchronised Islands Procedure** unless **NGET** considers that the nature of the **De-Synchronised Island** situation is such that either:-

- (i) the **OC9 De-Synchronised Island Procedure** does not cover the situation; or
- (ii) the provisions of the **OC9 De-Synchronised Island Procedure** are not appropriate,

in which case **NGET** will instruct the relevant **Users** and the **Users** will comply with **NGET's** instructions (which in the case of **Generators** will relate to generation and in the case of **Network Operators** will relate to **Demand**).

OC9.5.4 Agreeing Procedures

In relation to each relevant part of the **Total System**, **NGET**, the **Network Operator** and the relevant **Generator** will discuss and may agree a local procedure (an "**OC9 De-Synchronised Island Procedure**").

OC9.5.4.1 Where there is no relevant local procedure in place at 12th May 1997, or in the case where the need for an **OC9 De-Synchronised Island Procedure** arises for the first time, the following provisions shall apply:-

- (a) **NGET**, the **Network Operator(s)** and the relevant **Generator(s)** will discuss the need for, and the detail of, the **OC9 De-Synchronised Island Procedure**. As soon as the need for an **OC9 De-Synchronised Island Procedure** is identified by **NGET** or a **User**, and the party which identifies such a need will notify all affected **Users** (and **NGET**, if that party is a **User**), and **NGET** will initiate these discussions.
- (b) Each **OC9 De-Synchronised Island Procedure** will be in relation to a specific **Grid Supply Point**, but if there is more than one **Grid Supply Point** between **NGET** and the **Network Operator** then the **OC9 De-Synchronised Island Procedure** may cover all relevant **Grid Supply Points**. In Scotland, the **OC9 De-Synchronised Island Procedure** may also cover parts of the **GB Transmission System** connected to the **User's System(s)** and **Power Stations** directly connected to the **GB Transmission System** which are also likely to form part of the **Power Island**.
- (c) The **OC9 De-Synchronised Island Procedure** will:-
 - (i) record which **Users** and which **User Sites** are covered by the **OC9 De-Synchronised Island Procedure**;
 - (ii) record which of the three methods set out in OC9.5 (or combination of the three) shall apply, with any conditions as to applicability being set out as well;
 - (iii) set out what is required from **NGET** and each **User** should a **De-Synchronised Island** arise;
 - (iv) set out what action should be taken if the **OC9 De-Synchronised Island Procedure** does not cover a particular set of circumstances and will reflect that in the absence of any specified action, the provisions of OC9.5.3 will apply;
 - (v) in Scotland, the **OC9 De-Synchronised Island Procedure** may be produced with and include obligations on the **Relevant Transmission Licensee** ; and
 - (vi) in Scotland, where the **OC9 De-Synchronised Island Procedure** includes the establishment of a **De-synchronised Island**, describe the route for establishment of the **De-Synchronised Island**.

- (d) Each **OC9 De-Synchronised Island Procedure** shall be prepared by **NGET** to reflect the above discussions.
- (e) Each page of the **OC9 De-Synchronised Island Procedure** shall bear a date of issue and the issue number.
- (f) When an **OC9 De-Synchronised Island Procedure** is prepared, it shall be sent by **NGET** to the **Users** involved for confirmation of its accuracy.
- (g) The **OC9 De-Synchronised Island Procedure** shall then be signed on behalf of **NGET** and on behalf of each relevant **User** by way of written confirmation of its accuracy.
- (h) Once agreed under this OC9.5.4.1, the procedure will become an **OC9 De-Synchronised Island Procedure** under the **Grid Code** and (subject to any change pursuant to this OC9) will apply between **NGET**, **Relevant Transmission Licensee** and the relevant **Users** as if it were part of the **Grid Code**.
- (i) Once signed, a copy will be distributed by **NGET** to each **User** which is a party accompanied by a note indicating the issue number and the date of implementation.
- (j) **NGET** and **Users** must make the **OC9 De-Synchronised Island Procedure** readily available to the relevant operational staff.
- (k) If a new **User** connects to the **Total System** and needs to be included with an existing **OC9 De-Synchronised Island Procedure**, **NGET** will initiate a discussion with that **User** and the **Users** which are parties to the relevant **OC9 De-Synchronised Island Procedure**. The principles applying to a new **OC9 De-Synchronised Island Procedure** under this OC9.5.4.1 shall apply to such discussions and to any consequent changes.
- (l) If **NGET**, or any **User** which is a party to an **OC9 De-Synchronised Island Procedure**, becomes aware that a change is needed to that **OC9 De-Synchronised Island Procedure**, it shall (in the case of **NGET**) initiate a discussion between **NGET** and the relevant **Users** to seek to agree the relevant change. The principles applying to establishing a new **OC9 De-Synchronised Island Procedure** under this OC9.5.4.1 shall apply to such discussions and to any consequent changes. If a **User** becomes so aware, it shall contact **NGET** who will then initiate such discussions.
- (m) If in relation to any discussions, agreement cannot be reached between **NGET** and the relevant **Users**, **NGET** will operate the **System** on the basis that it will discuss which of the three methods set out in OC9.5.2.1 to OC9.5.2.3 would be most appropriate at the time, if practicable. The complexities and uncertainties of recovery from a **De-Synchronised Island** means that **NGET** will decide, having discussed the situation with the relevant **Users** and taking into account the fact that the three methods may not cover the situation or be appropriate, the approach which is to be followed. **NGET** will instruct the relevant **Users** and the **Users** will comply with **NGET's** instructions as provided in OC9.5.3.

OC9.5.4.2 Where there is a relevant local procedure in place at 12th May 1997, the following provisions shall apply:-

- (a) **NGET** and the **Network Operator** and the relevant **Generator(s)** will discuss the existing procedure to see whether it is consistent with the principles set out in this OC9.5.
- (b) If it is, then it shall become an **OC9 De-Synchronised Island Procedure** under this OC9, and the relevant provisions of OC9.5.4.1 shall apply.
- (c) If it is not, then the parties will discuss what changes are needed to ensure that it is consistent, and once agreed the procedure will become an **OC9 De-Synchronised Island Procedure** under this OC9, and the relevant provisions of OC9.5.4.1 shall apply.
- (d) If agreement cannot be reached between **NGET** and the relevant **Users** after a reasonable period of time, the existing procedure will cease to apply and **NGET** will operate the **System** on the basis that it will discuss which of the three methods set out in OC9.5.2.1 to OC9.5.2.3 would be most appropriate at the time, if practicable. The complexities and uncertainties of recovery from a **De-Synchronised Island** means that **NGET** will decide, having discussed the situation with the relevant **Users** and taking into account the fact that the three methods may not cover the situation or be appropriate, the approach which is to be followed. **NGET** will instruct the relevant **Users** and the **Users** will comply with **NGET's** instructions as provided in OC9.5.3.

OC9.5.5 Where the **GB Transmission System** is **Out of Synchronism** with the transmission system of an **Externally Interconnected System Operator**, **NGET** will, pursuant to the **Interconnection Agreement** with that **Externally Interconnected System Operator**, agree with that **Externally Interconnected System Operator** when its transmission system can be **Re-Synchronised** to the **GB Transmission System**.

OC9.6 JOINT SYSTEM INCIDENT PROCEDURE

OC9.6.1 A "Joint System Incident" is

- (a) an **Event**, wherever occurring (other than on an **Embedded Small Power Station** or **Embedded Medium Power Station**), which, in the opinion of **NGET** or a **User**, has or may have a serious and/or widespread effect.
- (b) In the case of an **Event** on a **User(s) System(s)** (other than on an **Embedded Small Power Station** or **Embedded Medium Power Station**), the effect must be on the **GB Transmission System**, and in the case of an **Event** on the **GB Transmission System**, the effect must be on a **User(s) System(s)** (other than on an **Embedded Small Power Station** or **Embedded Medium Power Station**).

Where an **Event** on a **User(s) System(s)** has or may have no effect on the **GB Transmission System**, then such an **Event** does not fall within **OC9** and accordingly **OC9** shall not apply to it.

- OC9.6.2 (a) (i) Each **User** (other than **Generators** which only have **Embedded Small Power Stations** and/or **Embedded Medium Power Stations**) will provide in writing to **NGET**, and
- (ii) **NGET** will provide in writing to each **User** (other than **Generators** which only have **Embedded Small Power Stations** and/or **Embedded Medium Power Stations**), a telephone number or numbers at which, or through which, senior management representatives nominated for this purpose and who are fully authorised to make binding decisions on behalf of **NGET** or the relevant **User**, as the case may be, can be contacted day or night when there is a **Joint System Incident**.
- (b) The lists of telephone numbers will be provided in accordance with the timing requirements of the **Bilateral Agreement** and/or **Construction Agreement** with that **User**, prior to the time that a **User** connects to the **GB Transmission System** and must be up-dated (in writing) as often as the information contained in them changes.

OC9.6.3 Following notification of an **Event** under **OC7**, **NGET** or a **User**, as the case may be, will, if it considers necessary, telephone the **User** or **NGET**, as the case may be, on the telephone number referred to in OC9.6.2, to obtain such additional information as it requires.

OC9.6.4 Following notification of an **Event** under **OC7**, and/or the receipt of any additional information requested pursuant to OC9.6.3, **NGET** or a **User**, as the case may be, will determine whether or not the **Event** is a **Joint System Incident**, and, if so, **NGET** and/or the **User** may set up an **Incident Centre** in order to avoid overloading the existing **NGET** or that **User's**, as the case may be, operational/control arrangements.

OC9.6.5 Where **NGET** has determined that an **Event** is a **Joint System Incident**, **NGET** shall, as soon as possible, notify all relevant **Users** that a **Joint System Incident** has occurred and, if appropriate, that it has established an **Incident Centre** and the telephone number(s) of its **Incident Centre** if different from those already supplied pursuant to OC9.6.2.

OC9.6.6 If a **User** establishes an **Incident Centre** it shall, as soon as possible, notify **NGET** that it has been established and the telephone number(s) of the **Incident Centre** if different from those already supplied pursuant to OC9.6.2.

OC9.6.7 **NGET's Incident Centre** and/or the **User's Incident Centre** will not assume any responsibility for the operation of the **GB Transmission System** or **User's System**, as the case may be, but will be the focal point in **NGET** or the **User**, as the case may be, for:-

- (a) the communication and dissemination of information between **NGET** and the senior management representatives of **User(s)**; or
- (b) between the **User** and the senior management representatives of **NGET**, as the case may be,

relating to the **Joint System Incident**. The term "**Incident Centre**" does not imply a specially built centre for dealing with **Joint System Incidents**, but is a communications focal point. During a **Joint System Incident**, the normal

communication channels, for operational/control communication between **NGET** and **Users** will continue to be used.

OC9.6.8 All communications between the senior management representatives of the relevant parties with regard to **NGET's** role in the **Joint System Incident** shall be made via **NGET's Incident Centre** if it has been established.

OC9.6.9 All communications between the senior management representatives of **NGET** and a **User** with regard to that **User's** role in the **Joint System Incident** shall be made via that **User's Incident Centre** if it has been established.

OC9.6.10 **NGET** will decide when conditions no longer justify the need to use its **Incident Centre** and will inform all relevant **Users** of this decision.

OC9.6.11 Each **User** which has established an **Incident Centre** will decide when conditions no longer justify the need to use that **Incident Centre** and will inform **NGET** of this decision.

<End of OC9>

OPERATING CODE NO.10
EVENT INFORMATION SUPPLY
CONTENTS

(This contents page does not form part of the Grid Code)

<u>Paragraph No/Title</u>	<u>Page Number</u>
OC10.1 INTRODUCTION	1
OC10.2 OBJECTIVE	1
OC10.3 SCOPE.....	1
OC10.4 PROCEDURE	1
OC10.4.1 Reporting.....	1
OC10.4.1.1 Written Reporting of Events by Users to NGET	1
OC10.4.1.2 Written Reporting of Events by NGET to Users	2
OC10.4.1.3 Form	2
OC10.4.1.4 Timing	2
OC10.4.2 Joint Investigations	3
APPENDIX – MATTERS TO BE INCLUDED IN A WRITTEN REPORT	4

OPERATING CODE NO.10

EVENT INFORMATION SUPPLY

OC10.1 INTRODUCTION

OC10.1.1. **Operating Code No.10** ("OC10") sets out:

OC10.1.1.1 the requirements for the reporting in writing and, where appropriate, more fully, those **Significant Incidents** which were initially reported to **NGET** or a **User** orally under **OC7**; and

OC10.1.1.2 the mechanism for the joint investigation of a **Significant Incident** or a series of **Significant Incidents** if **NGET** and the relevant **Users** agree.

OC10.2 OBJECTIVE

The objective of **OC10** is to facilitate the provision of more detailed information, in writing, of **Significant Incidents** which were initially orally reported under **OC7** and to enable joint investigations to take place if **NGET** and the relevant **Users** agree.

OC10.3 SCOPE

OC10.3.1 **OC10** applies to **NGET** and to **Users**, which in **OC10** means:-

- (a) **Generators** (other than those which only have **Embedded Small Power Stations** and/or **Embedded Medium Power Stations**);
- (b) **Network Operators**;
- (c) **Non-Embedded Customers**; and
- (d) **DC Converter Station** owners.

The procedure for **Event** information supply between **NGET** and **Externally Interconnected System Operators** is set out in the **Interconnection Agreement** with each **Externally Interconnected System Operator**.

OC10.4 PROCEDURE

OC10.4.1 REPORTING

OC10.4.1.1 Written Reporting of Events by Users to NGET

In the case of an **Event** which was initially reported by a **User** to **NGET** orally and subsequently determined by **NGET** to be a **Significant Incident**, and accordingly notified by **NGET** to a **User** pursuant to **OC7**, the **User** will give a written report to **NGET**, in accordance with **OC10**. **NGET** will not pass on this report to other affected **Users** but may use the information contained therein in preparing a report under **OC10** to another **User** (or in a report which **NGET** is required to submit under an **Interconnection Agreement**) in relation to a **Significant Incident** (or its equivalent under an **Interconnection Agreement** or **STC**) on the **GB**

Transmission System which has been caused by (or exacerbated by) the **Significant Incident** on the **User's System**.

OC10.4.1.2 Written Reporting of Events by NGET to Users

In the case of an **Event** which was initially reported by **NGET** to a **User** orally and subsequently determined by the **User** to be a **Significant Incident**, and accordingly notified by the **User** to **NGET** pursuant to **OC7**, **NGET** will give a written report to the **User**, in accordance with **OC10**. The **User** will not pass on the report to other affected **Users** but:

- (a) a **Network Operator** may use the information contained therein in preparing a written report to a **Generator** with a **Generating Unit** or a **Power Park Module** connected to its **System** or to a **DC Converter Station** owner with a **DC Converter** connected to its **System** or to another operator of a **User System** connected to its **System** in connection with reporting the equivalent of a **Significant Incident** under the **Distribution Code** (or other contract pursuant to which that **Generating Unit** or that **Power Park Module** or that **DC Converter** or **User System** is connected to its **System**) (if the **Significant Incident** on the **GB Transmission System** caused or exacerbated it); and
- (b) a **Generator** may use the information contained therein in preparing a written report to another **Generator** with a **Generating Unit** or a **Power Park Module** connected to its **System** or to the operator of a **User System** connected to its **System** if it is required (by a contract pursuant to which that **Generating Unit** or a **Power Park Module** or that is connected to its **System**) to do so in connection with the equivalent of a **Significant Incident** on its **System** (if the **Significant Incident** on the **GB Transmission System** caused or exacerbated it).

OC10.4.1.3 Form

A report under OC10.4.1 shall be sent to **NGET** or to a **User**, as the case may be, and will contain a confirmation of the oral notification given under **OC7** together with more details relating to the **Significant Incident** although it (and any response to any question asked) need not state the cause of the **Event** save to the extent permitted under OC7.4.6.7 and OC7.4.6.9, and such further information which has become known relating to the **Significant Incident** since the oral notification under **OC7**. The report should, as a minimum, contain those matters specified in the Appendix to **OC10**. The Appendix is not intended to be exhaustive. **NGET** or the **User**, as the case may be, may raise questions to clarify the notification and the giver of the notification will, in so far as it is able, answer any questions raised.

OC10.4.1.4 Timing

A full written report under OC10.4.1 must, if possible, be received by **NGET** or the **User**, as the case may be, within 2 hours of **NGET** or the **User**, as the case may be, receiving oral notification under **OC7**. If this is not possible, the **User** or **NGET**, as the case may be, shall, within this period, submit a preliminary report setting out, as a minimum, those matters specified in the Appendix to **OC10**. As soon as reasonably practical thereafter, the **User** or **NGET**, as the case may be, shall submit a full written report containing the information set out in OC10.4.1.3.

OC10.4.2 Joint Investigations

OC10.4.2.1 Where a **Significant Incident** (or series of **Significant Incidents**) has been declared and a report (or reports) under **OC10** submitted, **NGET** or a **User** which has either given or received a written report under **OC10** may request that a joint investigation of a **Significant Incident** should take place.

OC10.4.2.2 Where there has been a series of **Significant Incidents** (that is to say, where a **Significant Incident** has caused or exacerbated another **Significant Incident**) the party requesting a joint investigation or the recipient of such a request, may request that the joint investigation should include an investigation into that other **Significant Incident** (or **Significant Incidents**).

OC10.4.2.3 **NGET** or a **User** may also request that:-

- (i) an **Externally Interconnected System Operator** and/or
- (ii) **Interconnector User** or
- (iii) (in the case of a **Network Operator**) a **Generator** with a **Generating Unit** or a **Power Park Module** or a **DC Converter Station** owner with **DC Converter** connected to its **System** or another **User System** connected to its **System** or
- (iv) (in the case of a **Generator**) another **Generator** with a **Generating Unit** or a **Power Park Module** connected to its **System** or a **User System** connected to its **System**.

be included in the joint investigation.

OC10.4.2.4 A joint investigation will only take place if **NGET** and the **User** or **Users** involved agree to it (including agreement on the involvement of other parties referred to in OC10.4.2.3). The form and rules of, the procedure for, and all matters (including, if thought appropriate, provisions for costs and for a party to withdraw from the joint investigation once it has begun) relating to the joint investigation will be agreed at the time of a joint investigation and in the absence of agreement the joint investigation will not take place.

OC10.4.2.5 Requests relating to a proposed joint investigation will be in writing.

OC10.4.2.6 Any joint investigation under **OC10** is separate to any investigation under the **Disputes Resolution Procedure**.

APPENDIX

MATTERS, IF APPLICABLE TO THE **SIGNIFICANT INCIDENT**
AND TO THE RELEVANT **USER** (OR **NGET**, AS THE CASE MAY BE,)
TO BE INCLUDED IN A WRITTEN REPORT
GIVEN IN ACCORDANCE WITH OC10.4.1 AND OC10.4.2

1. Time and date of **Significant Incident**.
2. Location.
3. **Plant** and/or **Apparatus** directly involved (and not merely affected by the **Event**).
4. Description of **Significant Incident**.
5. **Demand** (in MW) and/or generation (in MW) interrupted and duration of interruption.
6. **Generating Unit, Power Park Module** or **DC Converter - Frequency** response (MW correction achieved subsequent to the **Significant Incident**).
7. **Generating Unit, Power Park Module** or **DC Converter - Mvar** performance (change in output subsequent to the **Significant Incident**).
8. Estimated time and date of return to service.

< End of OC10 >

OPERATING CODE NO.11

NUMBERING AND NOMENCLATURE OF HIGH VOLTAGE APPARATUS AT CERTAIN SITES

CONTENTS

(This contents page does not form part of the Grid Code)

<u>Paragraph No/Title</u>	<u>Page Number</u>
OC11.1 INTRODUCTION.....	1
OC11.2 OBJECTIVE.....	1
OC11.3 SCOPE	1
OC11.4 PROCEDURE.....	2
OC11.4.2 Transmission HV Apparatus on Users Sites	2
OC11.4.3 User HV Apparatus on Transmission Sites	2
OC11.4.4 Changes.....	3

OPERATING CODE NO.11

NUMBERING AND NOMENCLATURE OF HIGH VOLTAGE APPARATUS AT CERTAIN SITES

OC11.1 INTRODUCTION

OC11.1.1 **Operating Code No.11** ("OC11") sets out the requirement that:

- (a) **Transmission HV Apparatus on Users' Sites;** and
- (b) **User HV Apparatus on Transmission Sites;**

shall have numbering and nomenclature in accordance with the system used from time to time by **NGET**.

OC11.1.2 The numbering and nomenclature (if required under the system of numbering and nomenclature used from time to time by **NGET**) of each item of **HV Apparatus** shall be included in the **Operation Diagram** prepared for each **Transmission Site** or **User Site**, as the case may be. Further provisions on **Operation Diagrams** are contained in the **Connection Conditions** and in each **Bilateral Agreement**.

OC11.1.3 In **OC11** the term "**HV Apparatus**" includes any **SF₆ Gas Zones** associated with any **HV Apparatus**.

OC11.2 OBJECTIVE

OC11.2.1 The overall objective of **OC11** is to ensure, so far as possible, the safe and effective operation of the **Total System** and to reduce the risk of human error faults by requiring, in certain circumstances, that the numbering and nomenclature of **User's HV Apparatus** shall be in accordance with the system used from time to time by **NGET**.

OC11.3 SCOPE

OC11.3.1 **OC11** applies to **NGET** and to **Users**, which in **OC11** means:-

- (a) **Generators;**
- (b) **Network Operators;**
- (c) **Non-Embedded Customers;** and
- (d) **DC Converter Station** owners.

OC11.4 PROCEDURE

OC11.4.1.1 The term "**User Site**" means a site owned (or occupied pursuant to a lease, licence or other agreement) by a **User** in which there is a **Connection Point**. For the avoidance of doubt, where a site is owned by **NGET** (in England and Wales) or a **Relevant Transmission Licensee** (in Scotland) but occupied by a **User** (as aforesaid), the site is a **User Site**.

OC11.4.1.2 The term "**Transmission Site**" means a site owned (or occupied pursuant to a lease, licence or other agreement) by **NGET** (in England and Wales) or by a **Relevant Transmission Licensee** (in Scotland) in which there is a **Connection Point**. For the avoidance of doubt, where a site is owned by a **User** but occupied by **NGET** (in England and Wales) or a **Relevant Transmission Licensee** (in Scotland)(as aforesaid), the site is an **Transmission Site**.

OC11.4.2 Transmission HV Apparatus on Users' Sites

- (a) **Transmission HV Apparatus on Users' Sites** shall have numbering and nomenclature in accordance with the system used from time to time by **NGET**;
- (b) when **NGET** (for sites in England and Wales) or the **Relevant Transmission Licensee** (for sites in Scotland) is to install its **HV Apparatus** on a **User's Site**, **NGET** shall (unless it gives rise to a **Modification** under the **CUSC**, in which case the provisions of the **CUSC** as to the timing apply) notify the relevant **User** of the numbering and nomenclature to be adopted for that **HV Apparatus** at least eight months prior to proposed installation;
- (c) the notification will be made in writing to the relevant **User** and will consist of both a proposed **Operation Diagram** incorporating the proposed new **Transmission HV Apparatus** to be installed, its proposed numbering and nomenclature, and the date of its proposed installation;
- (d) the relevant **User** will respond in writing to **NGET** within one month of the receipt of the notification, confirming receipt and confirming either that any other **HV Apparatus** of the relevant **User** on such **User Site** does not have numbering and/or nomenclature which could be confused with that proposed by **NGET**, or, to the extent that it does, that the relevant other numbering and/or nomenclature will be changed before installation of the **Transmission HV Apparatus**;
- (e) the relevant **User** will not install, or permit the installation of, any **HV Apparatus** on such **User Site** which has numbering and/or nomenclature which could be confused with **Transmission HV Apparatus** which is either already on that **User Site** or which **NGET** has notified that **User** will be installed on that **User Site**.

OC11.4.3 User HV Apparatus on Transmission Sites

- (a) **User HV Apparatus on Transmission Sites** shall have numbering and nomenclature in accordance with the system used from time to time by **NGET**;

- (b) when a **User** is to install its **HV Apparatus** on an **Transmission Site**, or it wishes to replace existing **HV Apparatus** on an **Transmission Site** and it wishes to adopt new numbering and nomenclature for such **HV Apparatus**, the **User** shall (unless it gives rise to a **Modification** under the **CUSC** in which case the provisions of the **CUSC** as to the timing apply) notify **NGET** of the details of the **HV Apparatus** and the proposed numbering and nomenclature to be adopted for that **HV Apparatus**, at least eight months prior to proposed installation;
- (c) the notification will be made in writing to **NGET** and shall consist of both a proposed **Operation Diagram** incorporating the proposed new **HV Apparatus** of the **User** to be installed, its proposed numbering and nomenclature, and the date of its proposed installation;
- (d) **NGET** will respond in writing to the **User** within one month of the receipt of the notification stating whether or not **NGET** accepts the **User's** proposed numbering and nomenclature and, if they are not acceptable, it shall give details of the numbering and nomenclature which the **User** shall adopt for that **HV Apparatus**.

OC11.4.4 Changes

Where **NGET** in its reasonable opinion has decided that it needs to change the existing numbering or nomenclature of **Transmission HV Apparatus** on a **User's Site** or of **User's HV Apparatus** on an **Transmission Site**:

- (a) the provisions of paragraph OC11.4.2 shall apply to such change of numbering or nomenclature of **Transmission HV Apparatus** with any necessary amendments to those provisions to reflect that only a change is being made; and
- (b) in the case of a change in the numbering or nomenclature of **User's HV Apparatus** on an **Transmission Site**, **NGET** will (unless it gives rise to a **Modification** under the **CUSC**, in which case the provisions of the **CUSC** as to the timing apply) notify the **User** of the numbering and/or nomenclature the **User** shall adopt for that **HV Apparatus** (the notification to be in a form similar to that envisaged under OC11.4.2) at least eight months prior to the change being needed and the **User** will respond in writing to **NGET** within one month of the receipt of the notification, confirming receipt.

In either case the notification shall indicate the reason for the proposed change.

OC11.4.5 **Users** will be provided upon request with details of **NGET's** then current numbering and nomenclature system in order to assist them in planning the numbering and nomenclature for their **HV Apparatus** on **Transmission Sites**.

OC11.4.6 When a **User** installs **HV Apparatus** which is the subject of **OC11**, the **User** shall be responsible for the provision and erection of clear and unambiguous labelling showing the numbering and nomenclature. Where a **User** is required by **OC11** to change the numbering and/or nomenclature of **HV Apparatus** which is the subject of **OC11**, the **User** will be responsible for the provision and erection of clear and unambiguous labelling by the required date.

When either **NGET** (for sites in England and Wales), or a **Relevant Transmission Licensee** (for sites in Scotland) installs **HV Apparatus** which is the subject of

OC11, NGET shall be responsible for the provision and erection of a clear and unambiguous labelling showing the numbering and nomenclature. Where **NGET** changes the numbering and /or nomenclature of **HV Apparatus** which is the subject of **OC11, NGET** will be responsible for the provision and erection of clear and unambiguous labelling showing the numbering and nomenclature by the required date.

OC11.4.7 For sites in England and Wales, **NGET** will not change its system of numbering and nomenclature in use immediately prior to the **Transfer Date** (which is embodied in OM5 (Operation Memorandum No.5 - Numbering and Nomenclature of HV Apparatus on the CEGB Grid System Issue 3 June 1987)), other than to reflect new or newly adopted technology or **HV Apparatus**. For the avoidance of doubt, this OC11.4.7 refers to the system of numbering and nomenclature, and does not preclude changes to the numbering and/or nomenclature of **HV Apparatus** which are necessary to reflect newly installed **HV Apparatus**, or re-configuration of **HV Apparatus** installed, and similar changes being made in accordance with that system of numbering and nomenclature.

< End of OC11 >

OPERATING CODE NO.12

SYSTEM TESTS

CONTENTS

(This contents page does not form part of the Grid Code)

<u>Paragraph No/Title</u>	<u>Page Number</u>
OC12.1 INTRODUCTION.....	1
OC12.2 OBJECTIVE.....	1
OC12.3 SCOPE.....	1
OC12.4 PROCEDURE.....	2
OC12.4.1 Proposal Notice.....	2
OC12.4.2 Preliminary Notice and establishment of Test Panel.....	2
OC12.4.3 Test Panel.....	4
OC12.4.4 Proposal Report.....	5
OC12.4.5 Test Programme.....	5
OC12.4.6 Final Report.....	6
OC12.4.7 Timetable Reduction.....	7

OPERATING CODE NO.12

SYSTEM TESTS

OC12.1 INTRODUCTION

OC12.1.1 **Operating Code No.12** ("OC12") relates to **System Tests**, which are tests which involve simulating conditions or the controlled application of irregular, unusual or extreme conditions, on the **Total System** or any part of the **Total System**, but which do not include commissioning or recommissioning tests or any other tests of a minor nature.

OC12.1.2 **OC12** deals with the responsibilities and procedures for arranging and carrying out **System Tests** which have (or may have) an effect on the **Systems** of **NGET** and **Users** and/or on the **System** of any **Externally Interconnected System Operator**. Where a **System Test** proposed by a **User** will have no effect on the **GB Transmission System**, then such a **System Test** does not fall within **OC12** and accordingly **OC12** shall not apply to it. A **System Test** proposed by **NGET** which will have an effect on the **System** of a **User** will always fall within **OC12**.

OC12.2 OBJECTIVE

The overall objectives of **OC12** are:

OC12.2.1 to ensure, so far as possible, that **System Tests** proposed to be carried out either by:

- (a) a **User** which may have an effect on the **Total System** or any part of the **Total System** (in addition to that **User's System**) including the **GB Transmission System**; or
- (b) by **NGET** which may have an effect on the **Total System** or any part of the **Total System** (in addition to the **GB Transmission System**)

do not threaten the safety of either their personnel or the general public, cause minimum threat to the security of supplies and to the integrity of **Plant** and/or **Apparatus**, and cause minimum detriment to **NGET** and **Users**;

OC12.2.2 to set out the procedures to be followed for establishing and reporting **System Tests**.

OC12.3 SCOPE

OC12 applies to **NGET** and to **Users**, which in **OC12** means:-

- (a) **Generators**;
- (b) **Network Operators**;
- (c) **Non-Embedded Customers**; and
- (d) **DC Converter Station** owners.

The procedure for the establishment of **System Tests** on the **GB Transmission System**, with **Externally Interconnected System Operators** which do not affect any **User**, is set out in the **Interconnection Agreement** with each **Externally Interconnected System Operator**. The position of **Externally Interconnected System Operators** and **Interconnector Users** is also referred to in OC12.4.2.

OC12.4 PROCEDURE

OC12.4.1 Proposal Notice

OC12.4.1.1 Where a **User** has decided that it would like to undertake a **System Test** it shall submit a notice (a "**Proposal Notice**") to **NGET** at least twelve months in advance of the date it would like to undertake the proposed **System Test**.

OC12.4.1.2 The **Proposal Notice** shall be in writing and shall contain details of the nature and purpose of the proposed **System Test** and shall indicate the extent and situation of the **Plant** and/or **Apparatus** involved.

OC12.4.1.3 If **NGET** is of the view that the information set out in the **Proposal Notice** is insufficient, it will contact the person who submitted the **Proposal Notice** (the "**Test Proposer**") as soon as reasonably practicable, with a written request for further information. **NGET** will not be required to do anything under **OC12** until it is satisfied with the details supplied in the **Proposal Notice** or pursuant to a request for further information.

OC12.4.1.4 If **NGET** wishes to undertake a **System Test**, **NGET** shall be deemed to have received a **Proposal Notice** on that **System Test**.

OC12.4.1.5 Where, under **OC12**, **NGET** is obliged to notify or contact the **Test Proposer**, **NGET** will not be so obliged where it is **NGET** that has proposed the **System Test**. **Users** and the **Test Panel**, where they are obliged under **OC12** to notify, send reports to or otherwise contact both **NGET** and the **Test Proposer**, need only do so once where **NGET** is the proposer of the **System Test**.

OC12.4.2 Preliminary Notice and establishment of Test Panel

OC12.4.2.1 Using the information supplied to it under OC12.4.1 **NGET** will determine, in its reasonable estimation, which **Users**, other than the **Test Proposer**, may be affected by the proposed **System Test**. If **NGET** determines, in its reasonable estimation, that an **Externally Interconnected System Operator** and/or **Interconnector User** (or **Externally Interconnected System Operators** and/or **Interconnector Users**) may be affected by the proposed **System Test**, then (provided that the **Externally Interconnected System Operator** and/or **Interconnector User** (or each **Externally Interconnected System Operator** and/or **Interconnector User** where there is more than one affected) undertakes to all the parties to the **Grid Code** to be bound by the provisions of the **Grid Code** for the purposes of the **System Test**) for the purposes of the remaining provisions of this **OC12**, that **Externally Interconnected System Operator** and/or **Interconnector User** (or each of those **Externally Interconnected System Operators** and/or **Interconnector Users**) will be deemed to be a **User** and references to the **Total System** or to the

Plant and/or **Apparatus** of a **User** will be deemed to include a reference to the transmission or distribution system and plant and/or apparatus of that **Externally Interconnected System Operator** and/or **Interconnector User** or (as the case may be) those **Externally Interconnected System Operators** and/or **Interconnector Users**. In the event that the **Externally Interconnected System Operator** and/or **Interconnector User** (or any of the **Externally Interconnected System Operators** and/or **Interconnector Users** where there is more than one affected) refuses to so undertake, then the **System Test** will not take place.

OC12.4.2.2

NGET will appoint a person to co-ordinate the **System Test** (a "**Test Co-ordinator**") as soon as reasonably practicable after it has, or is deemed to have, received a **Proposal Notice** and in any event prior to the distribution of the **Preliminary Notice** referred to below. The **Test Co-ordinator** shall act as Chairman of the **Test Panel** and shall be an ex-officio member of the **Test Panel**.

- (a) Where **NGET** decides, in its reasonable opinion, that the **GB Transmission System** will or may be significantly affected by the proposed **System Test**, then the **Test Co-ordinator** will be a suitably qualified person nominated by **NGET** after consultation with the **Test Proposer** and the **Users** identified under OC12.4.2.1.
- (b) Where **NGET** decides, in its reasonable opinion, that the **GB Transmission System** will not be significantly affected by the proposed **System Test**, then the **Test Co-ordinator** will be a suitably qualified person nominated by the **Test Proposer** after consultation with **NGET**.
- (c) **NGET** will, as soon as reasonably practicable after it has received, or is deemed to have received, a **Proposal Notice**, contact the **Test Proposer** where the **Test Co-ordinator** is to be a person nominated by the **Test Proposer** and invite it to nominate a person as **Test Co-ordinator**. If the **Test Proposer** is unable or unwilling to nominate a person within seven days of being contacted by **NGET** then the proposed **System Test** will not take place.

OC12.4.2.3

NGET will notify all **Users** identified by it under OC12.4.2.1 of the proposed **System Test** by a notice in writing (a "**Preliminary Notice**") and will send a **Preliminary Notice** to the **Test Proposer**. The **Preliminary Notice** will contain:

- (a) the details of the nature and purpose of the proposed **System Test**, the extent and situation of the **Plant** and/or **Apparatus** involved and the identity of the **Users** identified by **NGET** under OC12.4.2.1 and the identity of the **Test Proposer**;
- (b) an invitation to nominate within one month a suitably qualified representative (or representatives, if the **Test Co-ordinator** informs **NGET** that it is appropriate for a particular **User** including the **Test Proposer**) to be a member of the **Test Panel** for the proposed **System Test**;

(c) the name of the **NGET** representative (or representatives) on the **Test Panel** for the proposed **System Test**; and

(d) the name of the **Test Co-ordinator** and whether he was nominated by the **Test Proposer** or by **NGET**.

OC12.4.2.4 The **Preliminary Notice** will be sent within one month of the later of either the receipt by **NGET** of the **Proposal Notice**, or of the receipt of any further information requested by **NGET** under OC12.4.1.3. Where **NGET** is the proposer of the **System Test**, the **Preliminary Notice** will be sent within one month of the proposed **System Test** being formulated.

OC12.4.2.5 Replies to the invitation in the **Preliminary Notice** to nominate a representative to be a member of the **Test Panel** must be received by **NGET** within one month of the date on which the **Preliminary Notice** was sent to the **User** by **NGET**. Any **User** which has not replied within that period will not be entitled to be represented on the **Test Panel**. If the **Test Proposer** does not reply within that period, the proposed **System Test** will not take place and **NGET** will notify all **Users** identified by it under OC12.4.2.1 accordingly.

OC12.4.2.6 **NGET** will, as soon as possible after the expiry of that one month period, appoint the nominated persons to the **Test Panel** and notify all **Users** identified by it under OC12.4.2.1 and the **Test Proposer**, of the composition of the **Test Panel**.

OC12.4.3 **Test Panel**

OC12.4.3.1 A meeting of the **Test Panel** will take place as soon as possible after **NGET** has notified all **Users** identified by it under OC12.4.2.1 and the **Test Proposer** of the composition of the **Test Panel**, and in any event within one month of the appointment of the **Test Panel**.

OC12.4.3.2 The **Test Panel** shall consider:

(a) the details of the nature and purpose of the proposed **System Test** and other matters set out in the **Proposal Notice** (together with any further information requested by **NGET** under OC12.4.1.3);

(b) the economic, operational and risk implications of the proposed **System Test**;

(c) the possibility of combining the proposed **System Test** with any other tests and with **Plant** and/or **Apparatus** outages which arise pursuant to the **Operational Planning** requirements of **NGET** and **Users**; and

(d) implications of the proposed **System Test** on the operation of the **Balancing Mechanism**, in so far as it is able to do so.

OC12.4.3.3 **Users** identified by **NGET** under OC12.4.2.1, the **Test Proposer** and **NGET** (whether or not they are represented on the **Test Panel**) shall be obliged to supply that **Test Panel**, upon written request, with such details as the **Test Panel** reasonably requires in order to consider the proposed **System Test**.

OC12.4.3.4 The **Test Panel** shall be convened by the **Test Co-ordinator** as often as he deems necessary to conduct its business.

OC12.4.4 **Proposal Report**

OC12.4.4.1 Within two months of first meeting the **Test Panel** will submit a report (a "**Proposal Report**"), which will contain:

- (a) proposals for carrying out the **System Test** (including the manner in which the **System Test** is to be monitored);
- (b) an allocation of costs (including un-anticipated costs) between the affected parties (the general principle being that the **Test Proposer** will bear the costs); and
- (c) such other matters as the **Test Panel** considers appropriate.

The **Proposal Report** may include requirements for indemnities to be given in respect of claims and losses arising from the **System Test**. All **System Test** procedures must comply with all applicable legislation.

OC12.4.4.2 If the **Test Panel** is unable to agree unanimously on any decision in preparing its **Proposal Report**, the proposed **System Test** will not take place and the **Test Panel** will be dissolved.

OC12.4.4.3 The **Proposal Report** will be submitted to **NGET**, the **Test Proposer** and to each **User** identified by **NGET** under OC12.4.2.1.

OC12.4.4.4 Each recipient will respond to the **Test Co-ordinator** with its approval of the **Proposal Report** or its reason for non-approval within fourteen days of receipt of the **Proposal Report**. If any recipient does not respond, the **System Test** will not take place and the **Test Panel** will be dissolved.

OC12.4.4.5 In the event of non-approval by one or more recipients, the **Test Panel** will meet as soon as practicable in order to determine whether the proposed **System Test** can be modified to meet the objection or objections.

OC12.4.4.6 If the proposed **System Test** cannot be so modified, the **System Test** will not take place and the **Test Panel** will be dissolved.

OC12.4.4.7 If the proposed **System Test** can be so modified, the **Test Panel** will, as soon as practicable, and in any event within one month of meeting to discuss the responses to the **Proposal Report**, submit a revised **Proposal Report** and the provisions of OC12.4.4.3 and OC12.4.4.4 will apply to that submission.

OC12.4.4.8 In the event of non-approval of the revised **Proposal Report** by one or more recipients, the **System Test** will not take place and the **Test Panel** will be dissolved.

OC12.4.5 **Test Programme**

OC12.4.5.1 If the **Proposal Report** (or, as the case may be, the revised **Proposal Report**) is approved by all recipients, the proposed **System Test** can

proceed and at least one month prior to the date of the proposed **System Test**, the **Test Panel** will submit to **NGET**, the **Test Proposer** and each **User** identified by **NGET** under OC12.4.2.1, a programme (the "**Test Programme**") stating the switching sequence and proposed timings of the switching sequence, a list of those staff involved in carrying out the **System Test** (including those responsible for site safety) and such other matters as the **Test Panel** deems appropriate.

OC12.4.5.2 The **Test Programme** will, subject to OC12.4.5.3, bind all recipients to act in accordance with the provisions of the **Test Programme** in relation to the proposed **System Test**.

OC12.4.5.3 Any problems with the proposed **System Test** which arise or are anticipated after the issue of the **Test Programme** and prior to the day of the proposed **System Test**, must be notified to the **Test Co-ordinator** as soon as possible in writing. If the **Test Co-ordinator** decides that these anticipated problems merit an amendment to, or postponement of, the **System Test**, he shall notify the **Test Proposer** (if the **Test Co-ordinator** was not appointed by the **Test Proposer**), **NGET** and each **User** identified by **NGET** under OC12.4.2.1 accordingly.

OC12.4.5.4 If on the day of the proposed **System Test**, operating conditions on the **Total System** are such that any party involved in the proposed **System Test** wishes to delay or cancel the start or continuance of the **System Test**, they shall immediately inform the **Test Co-ordinator** of this decision and the reasons for it. The **Test Co-ordinator** shall then postpone or cancel, as the case may be, the **System Test** and shall, if possible, agree with the **Test Proposer** (if the **Test Co-ordinator** was not appointed by the **Test Proposer**), **NGET** and all **Users** identified by **NGET** under OC12.4.2.1 another suitable time and date. If he cannot reach such agreement, the **Test Co-ordinator** shall reconvene the **Test Panel** as soon as practicable, which will endeavour to arrange another suitable time and date for the **System Test**, in which case the relevant provisions of **OC12** shall apply.

OC12.4.6 **Final Report**

OC12.4.6.1 At the conclusion of the **System Test**, the **Test Proposer** shall be responsible for preparing a written report on the **System Test** (the "**Final Report**") for submission to **NGET** and other members of the **Test Panel**. The **Final Report** shall be submitted within three months of the conclusion of the **System Test** unless a different period has been agreed by the **Test Panel** prior to the **System Test** taking place.

OC12.4.6.2 The **Final Report** shall not be submitted to any person who is not a member of the **Test Panel** unless the **Test Panel**, having considered the confidentiality issues arising, shall have unanimously approved such submission.

OC12.4.6.3 The **Final Report** shall include a description of the **Plant** and/or **Apparatus** tested and a description of the **System Test** carried out, together with the results, conclusions and recommendations.

OC12.4.6.4 When the **Final Report** has been prepared and submitted in accordance with OC12.4.6.1, the **Test Panel** will be dissolved.

OC12.4.7 Timetable Reduction

OC12.4.7.1 In certain cases a **System Test** may be needed on giving less than twelve months notice. In that case, after consultation with the **Test Proposer** and **User(s)** identified by **NGET** under OC12.4.2.1, **NGET** shall draw up a timetable for the proposed **System Test** and the procedure set out in OC12.4.2 to OC12.4.6 shall be followed in accordance with that timetable.

< End of OC12 >

BALANCING CODE No 1

PRE GATE CLOSURE PROCESS

CONTENTS

(This contents page does not form part of the Grid Code)

<u>Paragraph No/Title</u>	<u>Page No.</u>
BC1.1 INTRODUCTION	1
BC1.2 OBJECTIVE	1
BC1.3 SCOPE.....	1
BC1.4 SUBMISSION OF DATA.....	1
BC1.4.1 Communication with Users	2
BC1.4.2 Day Ahead Submissions	2
(a) Physical Notifications	3
(b) Quiescent Physical Notifications.....	4
(c) Export and Import Limits.....	4
(d) Bid-Offer Data	4
(e) Dynamic Parameters.....	4
(f) Other Relevant Data.....	4
(g) Joint BM Unit Data	5
BC1.4.3 Data Revisions.....	5
BC1.4.4 Receipt of BM Unit Data prior to Gate Closure.....	5
BC1.4.5 BM Unit Defaulting, Validity and Consistency Checking.....	6
BC1.4.6 Special Provisions relating to Interconnector Users	6
BC1.5 INFORMATION PROVIDED BY NGET	7
BC1.5.1 Demand Estimates.....	7
BC1.5.2 Indicated Margin and Indicated Imbalance.....	7
BC1.5.3 Provision of Updated Information	7
BC1.5.4 Reserve and Inadequate System Margin	7
BC1.5.5 System and Localised NRAPM (Negative Reserve Active Power Margin)	9
BC1.6 SPECIAL PROVISIONS RELATING TO NETWORK OPERATORS.....	10
BC1.6.1 User System Data from Network Operators	10
BC1.6.2 Notification Times to Network Operators.....	11

BC1.7 SPECIAL ACTIONS	11
APPENDIX 1 BM UNIT DATA.....	12
BC1.A.1.1 Physical Notifications.....	12
BC1.A.1.2 Quiescent Physical Notifications (QPN).....	13
BC1.A.1.3 Export and Import Limits.....	13
BC1.A.1.3.1 Maximum Export Limit.....	13
BC1.A.1.3.2 Maximum Import Limit	13
BC1.A.1.4 Bid Offer Data.....	14
BC1.A.1.5 Dynamic Parameters	15
BC1.A.1.6 CCGT Module Matrix.....	15
BC1.A.1.7 Cascade Hydro Scheme Matrix	17
BC1.A.1.8 Power Park Module Availability Matrix	17
APPENDIX 2 DATA TO BE MADE AVAILABLE BY NGET	19
BC1.A.2.1 Initial Day Ahead Demand Forecast	19
BC1.A.2.2 Initial Day Ahead Market Information	19
BC1.A.2.3 Current Day & Day Ahead Updated Market Information	19

BALANCING CODE No 1

PRE GATE CLOSURE PROCESS

BC1.1 INTRODUCTION

Balancing Code No1 (BC1) sets out the procedure for:

- (a) the submission of **BM Unit Data** and/or **Generating Unit Data** by each **BM Participant**;
- (b) the submission of certain **System** data by each **Network Operator**; and
- (c) the provision of data by **NGET**,

in the period leading up to **Gate Closure**.

BC1.2 OBJECTIVE

The procedure for the submission of **BM Unit Data** and/or **Generating Unit Data** is intended to enable **NGET** to assess which **BM Units** and **Generating Units** are expected to be operating in order that **NGET** can ensure (so far as possible) the integrity of the **GB Transmission System**, and the security and quality of supply.

Where reference is made in this **BC1** to **Generating Units** (unless otherwise stated) it only applies to:

- (a) each **Generating Unit** which forms part of the **BM Unit** of a **Cascade Hydro Scheme**; and
- (b) each **Generating Unit** at an **Embedded Exemptable Large Power Station** where the **Bilateral Agreement** specifies that **NGET** reasonably requires compliance with **BC1** on a **Generating Unit** basis.

BC1.3 SCOPE

BC1 applies to **NGET** and to **Users**, which in this **BC1** means:-

- (a) **BM Participants**;
- (b) **Externally Interconnected System Operators**; and
- (c) **Network Operators**.

BC1.4 SUBMISSION OF DATA

In the case of **BM Units** or **Generating Units Embedded** in a **User System**, any data submitted by **Users** under this **BC1** must represent the value of the data at the relevant **Grid Supply Point**.

BC1.4.1 Communication with Users

- (a) Submission of **BM Unit Data** and **Generating Unit Data** by **Users** to **NGET** specified in BC1.4.2 to BC1.4.4 (with the exception of BC1.4.2(f)) is to be by use of electronic data communications facilities, as provided for in CC.6.5.8. However, data specified in BC1.4.2(c) and BC1.4.2(e) only, may be revised by telephone following its initial submission by electronic data communication facilities.
- (b) In the event of a failure of the electronic data communication facilities, the data to apply in relation to a pre-**Gate Closure** period will be determined in accordance with the **Data Validation, Consistency and Defaulting Rules**, based on the most recent data received and acknowledged by **NGET**.
- (c) **Planned Maintenance Outages** will normally be arranged to take place during periods of low data transfer activity.
- (d) Upon any **Planned Maintenance Outage**, or following an unplanned outage described in BC1.4.1(b) (where it is termed a "failure") in relation to a pre-**Gate Closure** period:-
 - (i) **BM Participants** should continue to act in relation to any period of time in accordance with the **Physical Notifications** current at the time of the start of the **Planned Maintenance Outage** or the computer system failure in relation to each such period of time subject to the provisions of BC2.5.1. Depending on when in relation to **Gate Closure** the planned or unplanned maintenance outage arises such operation will either be operation in preparation for the relevant output in real time, or will be operation in real time. No further submissions of **BM Unit Data** and/or **Generating Unit Data** (other than data specified in BC1.4.2(c) and BC1.4.2(e)) should be attempted. Plant failure or similar problems causing significant deviation from **Physical Notification** should be notified to **NGET** by the submission of a revision to **Export and Import Limits** in relation to the **BM Unit** and /or **Generating Unit** so affected;
 - (ii) during the outage, revisions to the data specified in BC1.4.2(c) and BC1.4.2(e) may be submitted. Communication between **Users' Control Points** and **NGET** during the outage will be conducted by telephone; and
 - (iii) no data will be transferred from **NGET** to the **BMRA** until the communication facilities are re-established.

BC1.4.2 Day Ahead Submissions

Data for any **Operational Day** may be submitted to **NGET** up to several days in advance of the day to which it applies, as provided in the **Data Validation, Consistency and Defaulting Rules**. However, **Interconnector Users** must submit **Physical Notifications**, and any associated data as necessary, each day by 11:00 hours in respect of the next following **Operational Day** in order that the information used in relation to the capability of the respective **External Interconnection** is expressly provided. **NGET** shall not by the inclusion of this provision be prevented from utilising the provisions of BC1.4.5 if necessary.

The data may be modified by further data submissions at any time prior to **Gate Closure**, in accordance with the other provisions of **BC1**. The data to be used by

NGET for operational planning will be determined from the most recent data that has been received by **NGET** by 11:00 hours on the day before the **Operational Day** to which the data applies, or from the data that has been defaulted at 11:00 hours on that day in accordance with BC1.4.5. Any subsequent revisions received by **NGET** under the **Grid Code** will also be utilised by **NGET**. In the case of all data items listed below, with the exception of item (e), **Dynamic Parameters** (Day Ahead), the latest submitted or defaulted data, as modified by any subsequent revisions, will be carried forward into operational timescales. The individual data items are listed below:-

(a) **Physical Notifications**

Physical Notifications, being the data listed in **BC1** Appendix 1 under that heading, are required by **NGET** at 11:00 hours each day for each **Settlement Period** of the next following **Operational Day**, in respect of;

(1) **BM Units:-**

- (i) with a **Demand Capacity** with a magnitude of 50MW or more in England and Wales or 5MW or more in Scotland; or
- (ii) comprising **Generating Units** (as defined in the Glossary and Definitions and not limited by BC1.2) and/or **CCGT Modules** at and/or **Power Park Modules** in each case **Large Power Stations** and **Medium Power Stations**; or
- (iii) where the **BM Participant** chooses to submit **Bid-Offer Data** in accordance with BC1.4.2(d) for **BM Units** not falling within (i) or (ii) above,

and

(2) each **Generating Unit**.

Physical Notifications may be submitted to **NGET** by **BM Participants**, for the **BM Units**, and **Generating Units**, specified in this BC1.4.2(a) at an earlier time, or **BM Participants** may rely upon the provisions of BC1.4.5 to create the **Physical Notifications** by data defaulting pursuant to the **Grid Code** utilising the rules referred to in that paragraph at 11:00 hours in any day.

Physical Notifications (which must comply with the limits on maximum rates of change listed in **BC1** Appendix 1) must, subject to the following operating limits, represent the **User's** best estimate of expected input or output of **Active Power** and shall be prepared in accordance with **Good Industry Practice**. **Physical Notifications** for any **BM Unit**, and any **Generating Units**, should normally be consistent with the **Dynamic Parameters** and **Export and Import Limits** and must not reflect any **BM Unit** or any **Generating Units**, proposing to operate outside the limits of its **Demand Capacity** and (and in the case of **BM Units**) **Generation Capacity** and, in the case of a **BM Unit** comprising a **Generating Unit** (as defined in the Glossary and Definitions and not limited by BC1.2) or **CCGT Module** or **Power Park Module**, its **Registered Capacity**.

These **Physical Notifications** provide, amongst other things, indicative **Synchronising** and **De-Synchronising** times to **NGET** in respect of any **BM Unit** comprising a **Generating Unit** (as defined in the Glossary and Definitions and not limited by BC1.2) or **CCGT Module** or **Power Park Module**, and for any **Generating Units**, and provide an indication of significant **Demand** changes in respect of other **BM Units**.

(b) **Quiescent Physical Notifications**

Each **BM Participant** may, in respect of each of its **BM Units**, submit to **NGET** for each **Settlement Period** of the next following **Operational Day** the data listed in **BC1** Appendix 1 under the heading of “**Quiescent Physical Notifications**” to amend the data already held by **NGET** in relation to **Quiescent Physical Notifications**, which would otherwise apply for those **Settlement Periods**.

(c) **Export and Import Limits**

Each **BM Participant** may, in respect of each of its **BM Units** and its **Generating Units** submit to **NGET** for any part or for the whole of the next following **Operational Day** the data listed in **BC1** Appendix 1 under the heading of “**Export and Import Limits**” to amend the data already held by **NGET** in relation to **Export and Import Limits**, which would otherwise apply for those **Settlement Periods**.

Export and Import Limits respectively represent the maximum export to or import from the **GB Transmission System** for a **BM Unit** and a **Generating Unit** and are the maximum levels that the **BM Participant** wishes to make available and must be prepared in accordance with **Good Industry Practice**.

(d) **Bid-Offer Data**

Each **BM Participant** may, in respect of each of its **BM Units**, but must not in respect of its **Generating Units** submit to **NGET** for any **Settlement Period** of the next following **Operational Day** the data listed in **BC1** Appendix 1 under the heading of “**Bid-Offer Data**” to amend the data already held by **NGET** in relation to **Bid-Offer Data**, which would otherwise apply to those **Settlement Periods**. The submitted **Bid-Offer Data** will be utilised by **NGET** in the preparation and analysis of its operational plans for the next following **Operational Day**. **Bid-Offer Data** may not be submitted unless an automatic logging device has been installed at the **Control Point** for the **BM Unit** in accordance with CC.6.5.8(b).

(e) **Dynamic Parameters (Day Ahead)**

Each **BM Participant** may, in respect of each of its **BM Units**, but must not in respect of its **Generating Units** submit to **NGET** for the next following **Operational Day** the data listed in **BC1** Appendix 1 under the heading of “**Dynamic Parameters**” to amend that data already held by **NGET**.

These **Dynamic Parameters** shall reasonably reflect the expected true operating characteristics of the **BM Unit** and shall be prepared in accordance with **Good Industry Practice**. In any case where non-zero **QPN** data has been provided in accordance with BC1.4.2(b), the **Dynamic Parameters** will apply to the element being offered for control only, i.e. to the component of the **Physical Notification** between the **QPN** and the full level of the **Physical Notification**.

The **Dynamic Parameters** applicable to the next following **Operational Day** will be utilised by **NGET** in the preparation and analysis of its operational plans for the next following **Operational Day** and may be used to instruct certain **Ancillary Services**. For the avoidance of doubt, the **Dynamic Parameters** to be used in the current **Operational Day** will be those submitted in accordance with BC2.5.3.1.

(f) **Other Relevant Data**

By 11:00 hours each day each **BM Participant**, in respect of each of its **BM Units** and **Generating Units** for which **Physical Notifications** are being submitted, shall, if it has not already done so, submit to **NGET** (save in respect of item (vi) where the item shall be submitted only when reasonably required by **NGET**), in respect of the next following **Operational Day** the following:

- (i) in the case of a **CCGT Module**, a **CCGT Module Matrix** as described in **BC1 Appendix 1**;
 - (ii) details of any special factors which in the reasonable opinion of the **BM Participant** may have a material effect or present an enhanced risk of a material effect on the likely output (or consumption) of such **BM Unit(s)**. Such factors may include risks, or potential interruptions, to **BM Unit** fuel supplies, or developing plant problems, details of tripping tests, etc. This information will normally only be used to assist in determining the appropriate level of **Operating Margin** that is required under OC2.4.6;
 - (iii) in the case of **Generators**, any temporary changes, and their possible duration, to the **Registered Data** of such **BM Unit**;
 - (iv) in the case of **Suppliers**, details of **Customer Demand Management** taken into account in the preparation of its **BM Unit Data**;
 - (v) details of any other factors which **NGET** may take account of when issuing **Bid-Offer Acceptances** for a **BM Unit** (e.g., **Synchronising** or **De-Synchronising** Intervals, the minimum notice required to cancel a **Synchronisation**, etc); and
 - (vi) in the case of a **Cascade Hydro Scheme**, the **Cascade Hydro Scheme Matrix** as described in **BC1 Appendix 1**.
 - (vii) in the case of a **Power Park Module**, a **Power Park Module Availability Matrix** as described in **BC1 Appendix 1**.
- (g) **Joint BM Unit Data**
BM Participants may submit **Joint BM Unit Data** in accordance with the provisions of the **BSC**. For the purposes of the **Grid Code**, such data shall be treated as data submitted under **BC1**.

BC1.4.3

Data Revisions

The **BM Unit Data**, and **Generating Unit Data**, derived at 1100 hours each day under BC1.4.2 above may need to be revised by the **BM Participant** for a number of reasons, including for example, changes to expected output or input arising from revised contractual positions, plant breakdowns, changes to expected **Synchronising** or **De-Synchronising** times, etc, occurring before **Gate Closure**. **BM Participants** should use reasonable endeavours to ensure that the data held by **NGET** in relation to its **BM Units** and **Generating Units**, is accurate at all times. Revisions to **BM Unit Data**, and **Generating Unit Data** for any period of time up to **Gate Closure** should be submitted to **NGET** as soon as reasonably practicable after a change becomes apparent to the **BM Participant**. **NGET** will use reasonable endeavours to utilise the most recent data received from **Users**, subject to the application of the provisions of BC1.4.5, for its preparation and analysis of operational plans.

BC1.4.4

Receipt of BM Unit Data prior to Gate Closure

BM Participants submitting **Bid-Offer Data**, in respect of any **BM Unit** for use in the **Balancing Mechanism** for any particular **Settlement Period** in accordance with the **BSC**, must ensure that **Physical Notifications** and **Bid-Offer Data** for such **BM Units** are received in their entirety and logged into **NGET's** computer systems by the time of **Gate Closure** for that **Settlement Period**. In all cases the data received will be subject to the application under the **Grid Code** of the provisions of BC1.4.5.

For the avoidance of doubt, no changes to the **Physical Notification, QPN** data or **Bid-Offer Data** for any **Settlement Period** may be submitted to **NGET** after **Gate Closure** for that **Settlement Period**.

BC1.4.5 **BM Unit Data** Defaulting, Validity and Consistency Checking

In the event that no submission of any or all of the **BM Unit Data** and **Generating Unit Data** in accordance with BC1.4.2 in respect of an **Operational Day**, is received by **NGET** by 11:00 hours on the day before that **Operational Day**, **NGET** will apply the **Data Validation, Consistency and Defaulting Rules**, with the default rules applicable to **Physical Notifications, Quiescent Physical Notifications** and **Export and Import Limits** data selected as follows:

- (a) for an **Interconnector User's BM Unit**, the defaulting rules will set some or all of the data for that **Operational Day** to zero, unless the relevant Interconnector arrangements, as agreed with **NGET**, state otherwise (in which case (b) applies); and
- (b) for all other **BM Units** or **Generating Units**, the defaulting rules will set some or all of the data for that **Operational Day** to the values prevailing in the current **Operational Day**.

A subsequent submission by a **User** of a data item which has been so defaulted under the **Grid Code** will operate as an amendment to that defaulted data and thereby replace it. Any such subsequent submission is itself subject to the application under the **Grid Code** of the **Data Validation, Consistency and Defaulting Rules**.

BM Unit Data and **Generating Unit Data** submitted in accordance with the provisions of BC1.4.2 to BC1.4.4 will be checked under the **Grid Code** for validity and consistency in accordance with the **Data Validation, Consistency and Defaulting Rules**. If any **BM Unit Data** and **Generating Unit Data** so submitted fails the data validity and consistency checking, this will result in the rejection of all data submitted for that **BM Unit** or **Generating Unit** included in the electronic data file containing that data item and that **BM Unit's** or **Generating Unit's** data items will be defaulted under the **Grid Code** in accordance with the **Data Validation, Consistency and Defaulting Rules**. Data for other **BM Units** and **Generating Units** included in the same electronic data file will not be affected by such rejection and will continue to be validated and checked for consistency prior to acceptance. In the event that rejection of any **BM Unit Data** and **Generating Unit Data** occurs, details will be made available to the relevant **BM Participant** via the electronic data communication facilities. In the event of a difference between the **BM Unit Data** for the **Cascade Hydro Scheme** and sum of the data submitted for the **Generating Units** forming part of such **Cascade Hydro Scheme**, the **BM Unit Data** shall take precedence.

BC1.4.6 **Special Provisions relating to Interconnector Users**

- (a) The total of the relevant **Physical Notifications** submitted by **Interconnector Users** in respect of any period of time should not exceed the capability (in MW) of the respective **External Interconnection** for that period of time. In the event that it does, then **NGET** shall advise the **Externally Interconnected System Operator** accordingly. In the period between such advice and **Gate Closure**, one or more of the relevant **Interconnector Users** would be expected to submit revised **Physical Notifications** to **NGET** to eliminate any such over-provision.

- (b) In any case where, as a result of a reduction in the capability (in MW) of the **External Interconnection** in any period during an **Operational Day** which is agreed between **NGET** and an **Externally Interconnected System Operator** after 0900 hours on the day before the beginning of such **Operational Day**, the total of the **Physical Notifications** in the relevant period using that **External Interconnection**, as stated in the **BM Unit Data** exceeds the reduced capability (in MW) of the respective **External Interconnection** in that period then **NGET** shall notify the **Externally Interconnected System Operator** accordingly.

BC1.5 INFORMATION PROVIDED BY NGET

NGET shall provide data to the **Balancing Mechanism Reporting Agent** or **BSCCo** each day in accordance with the requirements of the **BSC** in order that the data may be made available to **Users** via the **Balancing Mechanism Reporting Service** (or by such other means) in each case as provided in the **BSC**. Where **NGET** provides such information associated with the secure operation of the **System** to the **Balancing Mechanism Reporting Agent**, the provision of that information is additionally provided for in the following sections of this BC1.5. **NGET** shall be taken to have fulfilled its obligations to provide data under BC1.5.1, BC1.5.2, and BC1.5.3 by so providing such data to the **Balancing Mechanism Reporting Agent**.

BC1.5.1 Demand Estimates

Normally by 0900 hours each day, **NGET** will make available to **Users** a forecast of **GB National Demand** and the **Demand** for a number of pre-determined constraint groups (which may be updated from time to time, as agreed between **NGET** and **BSCCo**) for each **Settlement Period** of the next following **Operational Day**. Normally by 1200 hours each day, **NGET** will make available to **Users** a forecast of **GB Transmission System Demand** for each **Settlement Period** of the next **Operational Day**. Further details are provided in Appendix 2.

BC1.5.2 Indicated Margin and Indicated Imbalance

Normally by 1200 hours each day, **NGET** will make available to **Users** an **Indicated Margin** and an **Indicated Imbalance** for each **Settlement Period** of the next following **Operational Day**. **NGET** will use reasonable endeavours to utilise the most recent data received from **Users** in preparing for this release of data. Further details are provided in Appendix 2.

BC1.5.3 Provision of Updated Information

NGET will provide updated information on **Demand** and other information at various times throughout each day, as detailed in Appendix 2. **NGET** will use reasonable endeavours to utilise the most recent data received from **Users** in preparing for this release of data.

BC1.5.4 Reserve and Inadequate System Margin

Contingency Reserve

- (a) The amount of **Contingency Reserve** required at the day ahead stage and in subsequent timescales will be decided by **NGET** on the basis of historical trends in the reduction in availability of **Large Power Stations** and increases in forecast **Demand** up to real time operation. Where **Contingency Reserve** is to be allocated to thermal **Gensets**, **NGET** will instruct through a combination of **Ancillary Services** instructions and **Bid-Offer Acceptances**, the time at which such **Gensets** are required to synchronise, such instructions

to be consistent with **Dynamic Parameters** and other contractual arrangements.

Operating Reserve

- (b) The amount of **Operating Reserve** required at any time will be determined by **NGET** having regard to the **Demand** levels, **Large Power Station** availability shortfalls and the greater of the largest secured loss of generation (ie, the loss of generation against which, as a requirement of the **Licence Standards**, the **GB Transmission System** must be secured) or loss of import from or sudden export to **External Interconnections**. **NGET** will allocate **Operating Reserve** to the appropriate **BM Units** and **Generating Units** so as to fulfil its requirements according to the **Ancillary Services** available to it and as provided in the **BCs**.

Inadequate System Margin

- (c) In the period following 1200 hours each day and in relation to the following **Operational Day**, **NGET** will monitor the total of the Maximum Export Limit component of the **Export and Import Limits** received against forecast **GB Transmission System Demand** and the **Operating Margin** and will take account of **Dynamic Parameters** to see whether the anticipated level of the **System Margin** for any period is insufficient.
- (d) Where the level of the **System Margin** for any period is, in **NGET's** reasonable opinion, anticipated to be insufficient, **NGET** will send (by such data transmission facilities as have been agreed) a **GB Transmission System Warning - Inadequate System Margin** in accordance with OC7.4.8 to each **Generator**, **Supplier**, **Externally Interconnected System Operator**, **Network Operator** and **Non-Embedded Customer**.
- (e) Where, in **NGET's** judgement the **System Margin** at any time during the current **Operational Day** is such that there is a high risk of **Demand** reduction being instructed, a **GB Transmission System Warning - High Risk of Demand Reduction** will be issued, in accordance with OC7.4.8.
- (f) The monitoring will be conducted on a regular basis and a revised **GB Transmission System Warning - Inadequate System Margin** or **High Risk of Demand Reduction** may be sent out from time to time, including within the post **Gate Closure** phase. This will reflect any changes in **Physical Notifications** and **Export and Import Limits** which have been notified to **NGET**, and will reflect any **Demand Control** which has also been so notified. This will also reflect generally any changes in the forecast **Demand** and the relevant **Operating Margin**.
- (g) To reflect changing conditions, a **GB Transmission System Warning - Inadequate System Margin** may be superseded by a **GB Transmission System Warning - High Risk of Demand Reduction** and vice-versa.
- (h) If the continuing monitoring identifies that the **System Margin** is anticipated, in **NGET's** reasonable opinion, to be sufficient for the period for which previously a **GB Transmission System Warning** had been issued, **NGET** will send (by such data transmission facilities as have been agreed) a **Cancellation of GB Transmission System Warning** to each **User** who had received a **GB Transmission System Warning - Inadequate System Margin** or **High Risk of Demand Reduction** for that period. The issue of a **Cancellation of GB Transmission System Warning** is not an assurance by

NGET that in the event the **System Margin** will be adequate, but reflects **NGET's** reasonable opinion that the insufficiency is no longer anticipated.

- (i) If continued monitoring indicates the **System Margin** becoming inadequate **NGET** may issue further **GB Transmission System Warnings - Inadequate System Margin** or **High Risk of Demand Reduction**.
- (j) **NGET** may issue a **GB Transmission System Warning - Inadequate System Margin** or **High Risk of Demand Reduction** for any period, not necessarily relating to the following **Operational Day**, where it has reason to believe there will be inadequate **System Margin** over a period (for example in periods of protracted **Plant** shortage, the provisions of OC7.4.8.6 apply).

BC1.5.5

System and Localised NRAPM (Negative Reserve Active Power Margin)

- (a) (i) **System Negative Reserve Active Power Margin**

Synchronised Gensets must at all times be capable of reducing output such that the total reduction in output of all **Synchronised Gensets** is sufficient to offset the loss of the largest secured demand on the **System** and must be capable of sustaining this response;

- (ii) **Localised Negative Reserve Active Power Margin**

Synchronised Gensets must at all times be capable of reducing output to allow transfers to and from the **System Constraint Group** (as the case may be) to be contained within such reasonable limit as **NGET** may determine and must be capable of sustaining this response.

- (b) **NGET** will monitor the total of **Physical Notifications** of exporting **BM Units** and **Generating Units** (where appropriate) received against forecast **Demand** and, where relevant, the appropriate limit on transfers to and from a **System Constraint Group** and will take account of **Dynamic Parameters** and **Export and Import Limits** received to see whether the level of **System NRAPM** or **Localised NRAPM** for any period is likely to be insufficient. In addition, **NGET** may increase the required margin of **System NRAPM** or **Localised NRAPM** to allow for variations in forecast **Demand**. In the case of **System NRAPM**, this may be by an amount (in **NGET's** reasonable discretion) not exceeding five per cent of forecast **Demand** for the period in question. In the case of **Localised NRAPM**, this may be by an amount (in **NGET's** reasonable discretion) not exceeding ten per cent of the forecast **Demand** for the period in question;
- (c) Where the level of **System NRAPM** or **Localised NRAPM** for any period is, in **NGET 's** reasonable opinion, likely to be insufficient **NGET** may contact all **Generators** in the case of low **System NRAPM** and may contact **Generators** in relation to relevant **Gensets** in the case of low **Localised NRAPM**. **NGET** will raise with each **Generator** the problems it is anticipating due to low **System NRAPM** or **Localised NRAPM** and will discuss whether, in advance of **Gate Closure**:-
 - (i) any change is possible in the **Physical Notification** of a **BM Unit** which has been notified to **NGET**; or
 - (ii) any change is possible to the **Physical Notification** of a **BM Unit** within an **Existing AGR Plant** within the **Existing AGR Plant Flexibility Limit**;

in relation to periods of low **System NRAPM** or (as the case may be) low **Localised NRAPM**. **NGET** will also notify each **Externally Interconnected System Operator** of the anticipated low **System NRAPM** or **Localised NRAPM** and request assistance in obtaining changes to **Physical Notifications** from **BM Units** in that **External System**.

- (d) Following **Gate Closure**, the procedure of BC2.9.4 will apply.

BC1.6 Special Provisions relating to Network Operators

BC1.6.1 User System Data from Network Operators

- (a) By 1000 hours each day each **Network Operator** will submit to **NGET** in writing, confirmation or notification of the following in respect of the next **Operational Day**:
- (i) constraints on its **User System** which **NGET** may need to take into account in operating the **GB Transmission System**. In this BC1.6.1 the term "constraints" shall include restrictions on the operation of **Embedded CCGT Units**, and/or **Embedded Power Park Modules** as a result of the **User System** to which the **CCGT Unit** and/or **Power Park Module** is connected at the **User System Entry Point** being operated or switched in a particular way, for example, splitting the relevant busbar. It is a matter for the **Network Operator** and the **Generator** to arrange the operation or switching, and to deal with any resulting consequences. The **Generator**, after consultation with the **Network Operator**, is responsible for ensuring that no **BM Unit Data** submitted to **NGET** can result in the violation of any such constraint on the **User System**.
 - (ii) the requirements of voltage control and Mvar reserves which **NGET** may need to take into account for **System** security reasons.
- (b) The form of the submission will be:
- (i) that of a **BM Unit** output or consumption (for MW and for Mvar, in each case a fixed value or an operating range, on the **User System** at the **User System Entry Point**, namely in the case of a **BM Unit** comprising a **Generating Unit** (as defined in the Glossary and Definitions and not limited by BC1.2) on the higher voltage side of the generator step-up transformer, or in the case of a **Power Park Module**, at the point of connection) required for particular **BM Units** (identified in the submission) connected to that **User System** for each **Settlement Period** of the next **Operational Day**;
 - (ii) adjusted in each case for MW by the conversion factors applicable for those **BM Units** to provide output or consumption at the relevant **Grid Supply Points**.
- (c) At any time and from time to time, between 1000 hours each day and the expiry of the next **Operational Day**, each **Network Operator** must submit to **NGET** in writing any revisions to the information submitted under this BC1.6.1.

BC1.6.2 Notification of Times to Network Operators

NGET will make available indicative **Synchronising** and **De-Synchronising** times to each **Network Operator**, but only relating to **BM Units** comprising a **Generating Unit** (as defined in the Glossary and Definitions and not limited by BC1.2) or a **Power Park Module** or a **CCGT Module Embedded** within that **Network Operator's User System** and those **Gensets** directly connected to the **GB Transmission System** which **NGET** has identified under **OC2** as being those which may, in the reasonable opinion of **NGET**, affect the integrity of that **User System**. If in preparing for the operation of the **Balancing Mechanism**, **NGET** becomes aware that a **BM Unit** directly connected to the **GB Transmission System** may, in its reasonable opinion, affect the integrity of that other **User System** which, in the case of a **BM Unit** comprising a **Generating Unit** (as defined in the Glossary and Definitions and not limited by BC1.2) or a **CCGT Module** or a **Power Park Module**, it had not so identified under **OC2**, then **NGET** may make available details of its indicative **Synchronising** and **De-Synchronising** times to that other **User** and shall inform the relevant **BM Participant** that it has done so, identifying the **BM Unit** concerned.

BC1.7 Special Actions

BC1.7.1 **NGET** may need to identify special actions (either pre- or post-fault) that need to be taken by specific **Users** in order to maintain the integrity of the **GB Transmission System** in accordance with the **Licence Standards** and **NGET Operational Strategy**.

- (a) For a **Generator** special actions will generally involve a **Load** change or a change of required Notice to Deviate from Zero NDZ, in a specific timescale on individual or groups of **Gensets**.
- (b) For **Network Operators** these special actions will generally involve **Load** transfers between **Grid Supply Points** or arrangements for **Demand** reduction by manual or automatic means.
- (c) For **Externally Interconnected System Operators** (in their co-ordinating role for **Interconnector Users** using their **External System**) these special actions will generally involve an increase or decrease of net power flows across an **External Interconnection** by either manual or automatic means.

BC1.7.2 These special actions will be discussed and agreed with the relevant **User** as appropriate. The actual implementation of these special actions may be part of an "emergency circumstances" procedure described under **BC2**. If not agreed, generation or **Demand** may be restricted or may be at risk.

BC1.7.3 **NGET** will normally issue the list of special actions to the relevant **Users** by 1700 hours on the day prior to the day to which they are to apply.

APPENDIX 1

BM UNIT DATA

More detail about valid values required under the **Grid Code** for **BM Unit Data** and **Generating Unit Data** may be identified by referring to the **Data Validation, Consistency and Defaulting Rules**. In the case of **Embedded BM Units** and **Generating Units** the **BM Unit Data** and the **Generating Unit Data** shall represent the value at the relevant **Grid Supply Point**. Where data is submitted on a **Generating Unit** basis, the provisions of this Appendix 1 shall in respect of such data submission apply as if references to **BM Unit** were replaced with **Generating Unit**. Where **NGET** and the relevant **User** agree, submission on a **Generating Unit** basis (in whole or in part) may be otherwise than in accordance with the provisions of the Appendix 1.

BC1.A.1.1 Physical Notifications

For each **BM Unit**, the **Physical Notification** is a series of MW figures and associated times, making up a profile of intended input or output of **Active Power** at the **Grid Entry Point** or **Grid Supply Point**, as appropriate. For each **Settlement Period**, the first “from time” should be at the start of the **Settlement Period** and the last “to time” should be at the end of the **Settlement Period**.

The input or output reflected in the **Physical Notification** for a single **BM Unit** (or the aggregate **Physical Notifications** for a collection of **BM Units** at a **Grid Entry Point** or **Grid Supply Point** or to be transferred across an **External Interconnection**, owned or controlled by a single **BM Participant**) must comply with the following limits regarding maximum rates of change, either for a single change or a series of related changes :

- for a change of up to 300MW no limit;
- for a change greater than 300MW and less than 1000MW 50MW per minute;
- for a change of 1000MW or more 40MW per minute,

unless prior arrangements have been discussed and agreed with **NGET**. This limitation is not intended to limit the Run-Up or Run-Down Rates provided as **Dynamic Parameters**.

An example of the format of **Physical Notification** is shown below. The convention to be applied is that where it is proposed that the **BM Unit** will be importing, the **Physical Notification** is negative.

Data Name	BMU name	Time From	From level (MW)	Time To	To Level (MW)
PN , TAGENT ,	BMUNIT01 ,	2001-11-03 06:30 ,	77 ,	2001-11-03 07:00 ,	100
PN , TAGENT ,	BMUNIT01 ,	2001-11-03 07:00 ,	100 ,	2001-11-03 07:12 ,	150
PN , TAGENT ,	BMUNIT01 ,	2001-11-03 07:12 ,	150 ,	2001-11-03 07:30 ,	175

A linear interpolation will be assumed between the **Physical Notification** From and To levels specified for the **BM Unit** by the **BM Participant**.

BC1.A.1.2 Quiescent Physical Notifications (QPN)

For each **BM Unit** (optional) A series of MW figures and associated times, which describe the MW levels to be deducted from the **Physical Notification** of a **BM Unit** to determine a resultant operating level to which the **Dynamic Parameters** associated with that **BM Unit** apply.

An example of the format of data is shown below.

Data Name	BMU name	Time From	From level (MW)	Time To	To level (MW)
QPN , TAGENT ,	BMUNIT04 ,	2001-11-03 06:30	, -200	, 2001-11-03 07:00	, -220
QPN , TAGENT ,	BMUNIT04 ,	2001-11-03 07:00	, -220	, 2001-11-03 07:18	, -245
QPN , TAGENT ,	BMUNIT04 ,	2001-11-03 07:18	, -245	, 2001-11-03 07:30	, -300

A linear interpolation will be assumed between the **QPN** From and To levels specified for the **BM Unit** by the **BM Participant**.

BC1.A.1.3 Export and Import Limits

BC1.A.1.3.1 Maximum Export Limit (MEL) A series of MW figures and associated times, making up a profile of the maximum level at which the **BM Unit** may be exporting (in MW) to the **GB Transmission System** at the **Grid Entry Point** or **Grid Supply Point**, as appropriate.

BC1.A.1.3.2 Maximum Import Limit (MIL) A series of MW figures and associated times, making up a profile of the maximum level at which the **BM Unit** may be importing (in MW) from the **GB Transmission System** at the **Grid Entry Point** or **Grid Supply Point**, as appropriate.

An example format of data is shown below. MEL must be positive or zero, and MIL must be negative or zero.

Data Name	BMU name	Time From	From level (MW)	Time To	To level (MW)
MEL , TAGENT ,	BMUNIT01 ,	2001-11-03 05:00	, 410	, 2001-11-03 09:35	, 410
MEL , TAGENT ,	BMUNIT01 ,	2001-11-03 09:35	, 450	, 2001-11-03 12:45	, 450
MIL , TAGENT ,	BMUNIT04 ,	2001-11-03 06:30	, -200	, 2001-11-03 07:00	, -220

BC1.A.1.4 Bid-Offer Data

For each **BM Unit** for Up to 10 Bid-Offer Pairs as defined in the **BSC**.
each **Settlement**
Period:

An example of the format of data is shown below.

Data Name	BMU name	Time from	Time to	Pair ID	From Level (MW)	To Level (MW)	Offer (£/ MWhr)	Bid (£/ MWhr)
BOD, TAGENT	, BMUNIT01	, 2000-10-28 12:00	, 2000-10-28 13:30	, 4	, 30	, 30	, 40	, 35
BOD, TAGENT	, BMUNIT01	, 2000-10-28 12:00	, 2000-10-28 13:30	, 3	, 20	, 20	, 35	, 30
BOD, TAGENT	, BMUNIT01	, 2000-10-28 12:00	, 2000-10-28 13:30	, 2	, 40	, 40	, 32	, 27
BOD, TAGENT	, BMUNIT01	, 2000-10-28 12:00	, 2000-10-28 13:30	, 1	, 50	, 50	, 30	, 25
BOD, TAGENT	, BMUNIT01	, 2000-10-28 12:00	, 2000-10-28 13:30	, -1	, -40	, -40	, 25	, 20
BOD, TAGENT	, BMUNIT01	, 2000-10-28 12:00	, 2000-10-28 13:30	, -2	, -30	, -30	, 23	, 17

This example of Bid-Offer data is illustrated graphically below:-

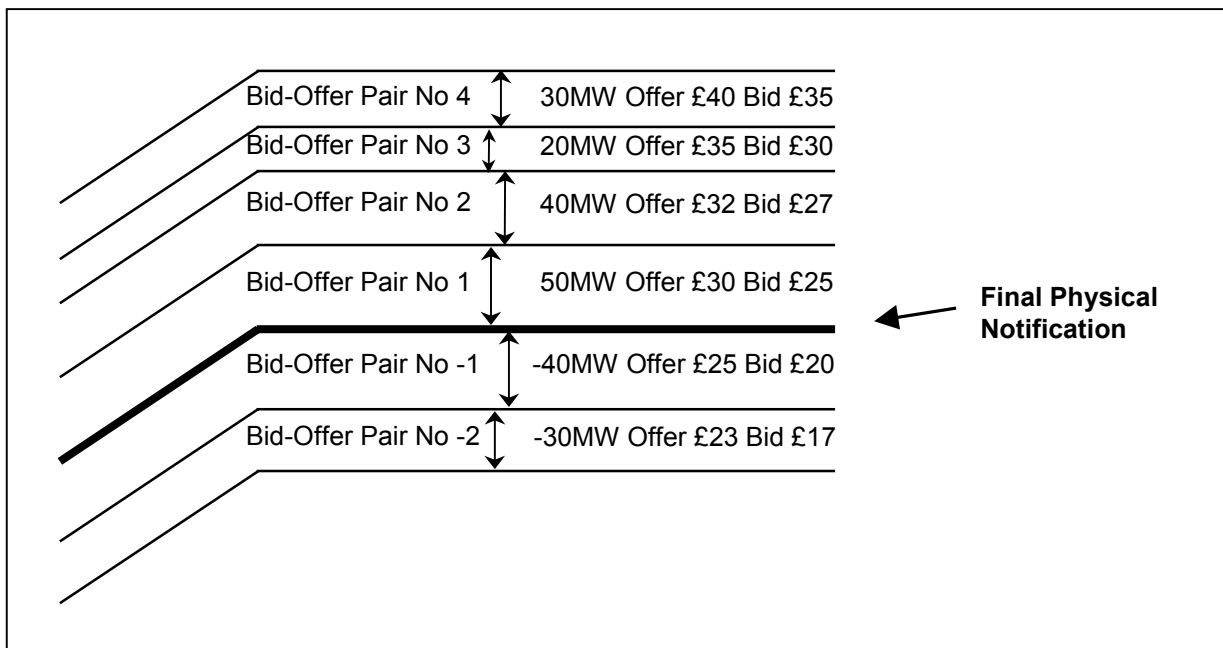

BC1.A.1.5 Dynamic Parameters

The **Dynamic Parameters** comprise:

- Up to three Run-Up Rate(s) and up to three Run-Down Rate(s), expressed in MW/minute and associated Run-Up Elbow(s) and Run-Down Elbow(s), expressed in MW for output and the same for input. It should be noted that Run-Up Rate(s) are applicable to a MW figure becoming more positive;
- Notice to Deviate from Zero (NDZ) output or input, being the notification time required for a **BM Unit** to start importing or exporting energy, from a zero **Physical Notification** level as a result of a **Bid-Offer Acceptance**, expressed in minutes;
- Notice to Deliver Offers (NTO) and Notice to Deliver Bids (NTB), expressed in minutes, indicating the notification time required for a **BM Unit** to start delivering Offers and Bids respectively from the time that the **Bid-Offer Acceptance** is issued. In the case of a **BM Unit** comprising a **Genset**, NTO and NTB will be set to a maximum period of two minutes;
- Minimum Zero Time (MZT), being either the minimum time that a **BM Unit** which has been exporting must operate at zero or be importing, before returning to exporting or the minimum time that a **BM Unit** which has been importing must operate at zero or be exporting before returning to importing, as a result of a **Bid-Offer Acceptance**, expressed in minutes;
- Minimum Non-Zero Time (MNZT), expressed in minutes, being the minimum time that a **BM Unit** can operate at a non-zero level as a result of a **Bid-Offer Acceptance**;
- Stable Export Limit (SEL) expressed in MW at the **Grid Entry Point** or **Grid Supply Point**, as appropriate, being the minimum value at which the **BM Unit** can, under stable conditions, export to the **GB Transmission System**;
- Stable Import Limit (SIL) expressed in MW at the **Grid Entry Point** or **Grid Supply Point**, as appropriate, being the minimum value at which the **BM Unit** can, under stable conditions, import from the **GB Transmission System**;
- Maximum Delivery Volume (MDV), expressed in MWh, being the maximum number of MWhr of Offer (or Bid if MDV is negative) that a particular **BM Unit** may deliver within the associated Maximum Delivery Period (MDP), expressed in minutes, being the maximum period over which the MDV applies.

BC1.A.1.6 CCGT Module Matrix

BC1.A.1.6.1 **CCGT Module Matrix** showing the combination of **CCGT Units** running in relation to any given MW output, in the form of the diagram illustrated below. The **CCGT Module Matrix** is designed to achieve certainty in knowing the number of **CCGT Units** synchronised to meet the **Physical Notification** and to achieve a **Bid-Offer Acceptance**.

BC1.A.1.6.2 In the case of a **Range CCGT Module**, and if the **Generator** so wishes, a request for the single **Grid Entry Point** at which power is provided from the **Range CCGT Module** to be changed in accordance with the provisions of BC1.A.1.6.4 below:-

CCGT Module Matrix example form

CCGT MODULE ACTIVE POWER	CCGT GENERATING UNITS* AVAILABLE								
	1st GT	2 nd GT	3 rd GT	4th GT	5th GT	6th GT	1st ST	2nd ST	3rd ST
MW	ACTIVE POWER OUTPUT								
	150	150	150				100		
0MW to 150MW	/								
151MW to 250MW	/						/		
251MW to 300MW	/	/							
301MW to 400MW	/	/					/		
401MW to 450MW	/	/	/						
451MW to 550MW	/	/	/				/		

* as defined in the Glossary and Definitions and not limited by BC1.2

BC1.A.1.6.3 In the absence of the correct submission of a **CCGT Module Matrix** the last submitted (or deemed submitted) **CCGT Module Matrix** shall be taken to be the **CCGT Module Matrix** submitted hereunder.

BC1.A.1.6.4 The data may also include in the case of a **Range CCGT Module**, a request for the **Grid Entry Point** at which the power is provided from the **Range CCGT Module** to be changed with effect from the beginning of the following **Operational Day** to another specified single **Grid Entry Point** (there can be only one) to that being used for the current **Operational Day**. **NGET** will respond to this request by 1600 hours on the day of receipt of the request. If **NGET** agrees to the request (such agreement not to be unreasonably withheld), the **Generator** will operate the **Range CCGT Module** in accordance with the request. If **NGET** does not agree, the **Generator** will, if it produces power from that **Range CCGT Module**, continue to provide power from the **Range CCGT Module** to the **Grid Entry Point** being used at the time of the request. The request can only be made up to 1100 hours in respect of the following **Operational Day**. No subsequent request to change can be made after 1100 hours in respect of the following **Operational Day**. Nothing in this paragraph shall prevent the busbar at the **Grid Entry Point** being operated in separate sections.

BC1.A.1.6.5 The principles set out in PC.A.3.2.3 apply to the submission of a **CCGT Module Matrix** and accordingly the **CCGT Module Matrix** can only be amended as follows:-

(a) Normal CCGT Module

if the **CCGT Module** is a **Normal CCGT Module**, the **CCGT Units** within that **CCGT Module** can only be amended such that the **CCGT Module** comprises different **CCGT Units** if **NGET** gives its prior consent in writing. Notice of the wish to amend the **CCGT Units** within such a **CCGT Module** must be given at least 6 months before it is wished for the amendment to take effect;

(b) Range CCGT Module

if the **CCGT Module** is a **Range CCGT Module**, the **CCGT Units** within that **CCGT Module** can only be amended such that the **CCGT Module** comprises different **CCGT Units** for a particular **Operational Day** if the relevant notification is given by 1100 hours on the day prior to the **Operational Day** in which the amendment is to take effect. No subsequent amendment may be made to the **CCGT Units** comprising the **CCGT Module** in respect of that particular **Operational Day**.

BC1.A.1.6.6 In the case of a **CCGT Module Matrix** submitted (or deemed to be submitted) as part of the other data for **CCGT Modules**, the output of the **CCGT Module** at any given instructed MW output must reflect the details given in the **CCGT Module Matrix**. It is accepted that in cases of change in MW in response to instructions issued by **NGET** there may be a transitional variance to the conditions reflected in the **CCGT Module Matrix**. In achieving an instruction the range of number of **CCGT Units** envisaged in moving from one MW output level to the other must not be departed from. Each **Generator** shall notify **NGET** as soon as practicable after the event of any such variance. It should be noted that there is a provision above for the **Generator** to revise the **CCGT Module Matrix**, subject always to the other provisions of this **BC1**;

BC1.A.1.6.7 Subject as provided above, **NGET** will rely on the **CCGT Units** specified in such **CCGT Module Matrix** running as indicated in the **CCGT Module Matrix** when it issues an instruction in respect of the **CCGT Module**;

BC1.A.1.6.8 Subject as provided in BC1.A.1.6.5 above, any changes to the **CCGT Module Matrix** must be notified immediately to **NGET** in accordance with the relevant provisions of **BC1**.

BC1.A.1.7 Cascade Hydro Scheme Matrix

BC1.A.1.7.1 A **Cascade Hydro Scheme Matrix** showing the performance of individual **Generating Units** forming part of a **Cascade Hydro Scheme** in response to **Bid- Offer Acceptance**. An example table is shown below:

Cascade Hydro Scheme Matrix example form

Plant	Synchronises when offer is greater than.....
Generating Unit 1MW
Generating Unit 2MW
Generating Unit 3MW
Generating Unit 4MW
Generating Unit 5MW

BC1.A.1.8 Power Park Module Availability Matrix

BC1.A.1.8.1 **Power Park Module Availability Matrix** showing the number of each type of **Power Park Units** expected to be available is illustrated in the example form below. The **Power Park Module Availability Matrix** is designed to achieve certainty in knowing the number of **Power Park Units Synchronised** to meet the **Physical Notification** and to achieve a **Bid-Offer Acceptance**. The **Power Park Module Availability Matrix** may have as many columns as are required to provide information on the different make and model for each type of **Power Park Unit** in a **Power Park**

Module. The description is required to assist identification of the **Power Park Units** within the **Power Park Module** and correlation with data provided under the **Planning Code**.

Power Park Module Availability Matrix example form

POWER PARK UNIT AVAILABILITY	POWER PARK UNITS			
	Type A	Type B	Type C	Type D
Description (Make/Model)				
Number of units				

- BC1.A.1.8.2 In the absence of the correct submission of a **Power Park Module Availability Matrix** the last submitted (or deemed submitted) **Power Park Module Availability Matrix** shall be taken to be the **Power Park Module Availability Matrix** submitted hereunder.
- BC1.A.1.8.3 **NGET** will rely on the **Power Park Units** specified in such **Power Park Module Availability Matrix** running as indicated in the **Power Park Module Availability Matrix** when it issues an instruction in respect of the **Power Park Module**;
- BC1.A.1.8.4 Subject as provided in PC.A.3.2.4 any changes to the **Power Park Module Availability Matrix** must be notified immediately to **NGET** in accordance with the relevant provisions of **BC1**.

APPENDIX 2

DATA TO BE MADE AVAILABLE BY NGET

BC1.A.2.1 Initial Day Ahead Demand Forecast

Normally by 09:00 hours each day, values (in MW) for each **Settlement Period** of the next following **Operational Day** of the following data items:-

- i) Initial forecast of **GB National Demand**;
- ii) Initial forecast of **Demand** for a number of predetermined constraint groups.

BC1.A.2.2 Initial Day Ahead Market Information

Normally by 12:00 hours each day, values (in MW) for each **Settlement Period** of the next following **Operational Day** of the following data items:-

- i) **Initial National Indicated Margin**

This is the difference between the sum of **BM Unit** MELs and the forecast of **GB Transmission System Demand**.
- ii) **Initial National Indicated Imbalance**

This is the difference between the sum of **Physical Notifications** for **BM Units** comprising **Generating Units** (as defined in the Glossary and Definitions and not limited by BC1.2) or **CCGT Modules** or **Power Park Modules** and the forecast of **GB Transmission System Demand**.
- iii) **Forecast of GB Transmission System Demand**.

BC1.A.2.3 Current Day and Day Ahead Updated Market Information

Data will normally be made available by the times shown below for the associated periods of time:

Target Data Release Time	Period Start Time	Period End Time
02:00	02:00 D0	05:00 D+1
10:00	10:00 D0	05:00 D+1
16:00	05:00 D+1	05:00 D+2
16:30	16:30 D0	05:00 D+1
22:00	22:00 D0	05:00 D+2

In this table, D0 refers to the current day, D+1 refers to the next day and D+2 refers to the day following D+1.

In all cases, data will be ½ hourly average MW values calculated by **NGET**. Information to be released includes:-

National Information

- i) **National Indicated Margin**;

- ii) National **Indicated Imbalance**;
- iii) Updated forecast of **GB Transmission System Demand**.

Constraint Boundary Information (for each Constraint Boundary)

- i) **Indicated Constraint Boundary Margin**;

This is the difference between the Constraint Boundary Transfer limit and the difference between the sum of **BM Unit** MELs and the forecast of local **Demand** within the constraint boundary.

- ii) Local **Indicated Imbalance**;

This is the difference between the sum of **Physical Notifications** for **BM Units** comprising **Generating Units** (as defined in the Glossary and Definitions and not limited by BC1.2) or **CCGT Modules** or **Power Park Modules** and the forecast of local **Demand** within the constraint boundary.

- iii) Updated forecast of the local **Demand** within the constraint boundary.

< End of BC1 >

BALANCING CODE No 2

POST GATE CLOSURE PROCESS

CONTENTS

(This contents page does not form part of the Grid Code)

<u>Paragraph No/Title</u>	<u>Page Number</u>
BC2.1 INTRODUCTION.....	1
BC2.2 OBJECTIVE	1
BC2.3 SCOPE.....	1
BC2.4 INFORMATION USED.....	2
BC2.5 PHYSICAL OPERATION OF BM UNITS	2
BC2.5.1 Accuracy of Physical Notifications.....	2
BC2.5.2 Synchronising and De-Synchronising times	3
BC2.5.3 Revisions to BM Unit Data	4
BC2.5.4 Operation in the Absence of Instructions from NGC.....	5
BC2.5.5 Commencement or Termination of Participation in the Balancing Mechanism.....	6
BC2.6 COMMUNICATIONS	7
BC2.6.1 Normal Communications with Control Points	7
BC2.6.2 Communication with Control Points in Emergency Circumstances.....	8
BC2.6.3 Communication with Network Operators in Emergency Circumstances	8
BC2.6.4 Communication with Externally Interconnected System Operators in Emergency Circumstances	8
BC2.6.5 Communications during planned outages of electronic data communication facilities	9
BC2.7 BID-OFFER ACCEPTANCES.....	9
BC2.7.1 Acceptance of bids and offers by NGC	9
BC2.7.2 Consistency with Export and Import Limits, QPNs and Dynamic Parameters.....	10
BC2.7.3 Confirmation and Rejection of Acceptances.....	10
BC2.7.4 Action Required from BM Participants.....	11
BC2.7.5 Additional Action Required from Generators	11
BC2.8 ANCILLARY SERVICES.....	11

BC2.8.1	Call-off of Ancillary Services by NGC	11
BC2.8.2	Consistency with Export and Import Limits, QPNs and Dynamic Parameters	12
BC2.8.3	Rejection of Ancillary Service instructions.....	12
BC2.8.4	Action Required from BM Units.....	12
BC2.9	EMERGENCY CIRCUMSTANCES.....	13
BC2.9.1	Emergency Actions.....	13
BC2.9.2	Implementation of Emergency Instructions	14
BC2.9.3	Examples of Emergency Instructions	14
BC2.9.4	Maintaining adequate System and Localised NRAPM (Negative Reserve Active Power Margin).....	15
BC2.9.5	Maintaining adequate Frequency Sensitive Generating Units	16
BC2.9.6	Emergency Assistance to and from External Systems	17
BC2.9.7	Unplanned Outages of electronic communication and computing facilities.....	17
BC2.10	OTHER OPERATIONAL INSTRUCTIONS AND NOTIFICATIONS	18
BC2.11	LIAISON WITH GENERATORS FIR RISK OF TRIP AND AVR TESTING.....	18
BC2.12	LIAISON WITH EXTERNALLY INTERCONNECTED SYSTEM OPERATORS.....	19
APPENDIX 1	FORM OF BID-OFFER ACCEPTANCES	21
APPENDIX 2	TYPE AND FORM OF ANCILLARY SERVICE INSTRUCTIONS	23
APPENDIX 3	SUBMISSION OF REVISED Mvar CAPABILITY	28
APPENDIX 4	Submission of availability of Frequency Sensitive Mode.....	31

BALANCING CODE No 2

POST GATE CLOSURE PROCESS

BC2.1 INTRODUCTION

Balancing Code No 2 (BC2) sets out the procedure for:

- a) the physical operation of **BM Units** and **Generating Units** in the absence of any instructions from **NGET**;
- b) the acceptance by **NGET** of **Balancing Mechanism** Bids and Offers,
- c) the calling off by **NGET** of **Ancillary Services**;
- d) the issuing and implementation of **Emergency Instructions**; and
- e) the issuing by **NGET** of other operational instructions and notifications.

In addition, **BC2** deals with any information exchange between **NGET** and **BM Participants** or specific **Users** that takes place after **Gate Closure**.

In this **BC2**, “consistent” shall be construed as meaning to the nearest integer MW level.

In this **BC2**, references to “a **BM Unit** returning to its **Physical Notification**” shall take account of any **Bid-Offer Acceptances** already issued to the **BM Unit** in accordance with BC2.7 and any **Emergency Instructions** already issued to the **BM Unit** or **Generating Unit** in accordance with BC2.9.

BC2.2 OBJECTIVE

The procedure covering the operation of the **Balancing Mechanism** and the issuing of instructions to **Users** is intended to enable **NGET** as far as possible to maintain the integrity of the **GB Transmission System** together with the security and quality of supply.

Where reference is made in this **BC2** to **Generating Units** (unless otherwise stated) it only applies to:

- (a) each **Generating Unit** which forms part of the **BM Unit** of a **Cascade Hydro Scheme**; and
- (b) each **Generating Unit** at an **Embedded Exemptable Large Power Station** where the **Bilateral Agreement** specifies that **NGET** reasonably requires compliance with certain provisions of **BC2** on a **Generating Unit** basis.

BC2.3 SCOPE

BC2 applies to **NGET** and to **Users**, which in this **BC2** means:-

- (a) **BM Participants**;

- (b) **Externally Interconnected System Operators**, and
- (c) **Network Operators**.

BC2.4 INFORMATION USED

BC2.4.1 The information which **NGET** shall use, together with the other information available to it, in assessing:-

- (a) which bids and offers to accept;
- (b) which **BM Units** and/or **Generating Units** to instruct to provide **Ancillary Services**;
- (c) the need for and formulation of **Emergency Instructions**; and
- (d) other operational instructions and notifications which **NGET** may need to issue

will be:

- (a) the **Physical Notification** and **Bid-Offer Data** submitted under **BC1**;
- (b) **Export and Import Limits, QPNs, and Joint BM Unit Data** in respect of that **BM Unit** and/or **Generating Unit** supplied under **BC1** (and any revisions under **BC1** and **BC2** to the data); and
- (c) **Dynamic Parameters** submitted or revised under this **BC2**.

BC2.4.2 As provided for in BC1.5.4, **NGET** will monitor the total of the Maximum Export Limit component of the **Export and Import Limits** against forecast **Demand** and the **Operating Margin** and will take account of **Dynamic Parameters** to see whether the anticipated level of **System Margin** is insufficient. This will reflect any changes in **Export and Import Limits** which have been notified to **NGET**, and will reflect any **Demand Control** which has also been so notified. **NGET** may issue new or revised **GB Transmission System Warnings – Inadequate System Margin** or **High Risk of Demand Reduction** in accordance with BC1.5.4.

BC2.5 PHYSICAL OPERATION OF BM UNITS

BC2.5.1 Accuracy of Physical Notifications

As described in BC1.4.2(a), **Physical Notifications** must represent the **BM Participant's** best estimate of expected input or output of **Active Power** and shall be prepared in accordance with **Good Industry Practice**. Each **BM Participant** must, applying **Good Industry Practice**, ensure that each of its **BM Units** follows the **Physical Notification** in respect of that **BM Unit** (and each of its **Generating Units** follows the **Physical Notification** in the case of **Physical Notifications** supplied under BC1.4.2(a)(2)) prevailing at **Gate Closure** (the data in which will be utilised in producing the **Final Physical Notification Data** in accordance with the **BSC**) subject to:

- (a) variations arising from the issue of **Bid-Offer Acceptances** which have been confirmed by the **BM Participant**;

- (b) instructions by **NGET** in relation to that **BM Unit** (or a **Generating Unit**) which require, or compliance with which would result in, a variation in output or input of that **BM Unit** (or a **Generating Unit**); or
- (c) any variations arising from compliance with provisions of **BC1**, **BC2** or **BC3** which provide to the contrary,

(which in each case gives rise to an obligation (applying **Good Industry Practice**) to follow such **Physical Notification** as amended by such variations and/or instructions), unless in relation to any such obligation it is prevented from so doing as a result of an unavoidable event (existing or anticipated) in relation to that **BM Unit** (or a **Generating Unit**) which requires a variation in output or input of that **BM Unit** (or a **Generating Unit**). Examples (on a non-exhaustive basis) of such an unavoidable event are plant breakdowns, events requiring a variation of input or output on safety grounds (relating to personnel or plant), events requiring a variation of input or output to maintain compliance with the relevant Statutory Water Management obligations and uncontrollable variations of input of **Active Power**.

Any anticipated variation in input or output from the **Physical Notification** in respect of that **BM Unit** (or a **Generating Unit**) prevailing at **Gate Closure** (except for variations arising from the issue of **Bid-Offer Acceptances** or instructions by **NGET** as outlined above) for any **BM Unit** (or a **Generating Unit**) post **Gate Closure** must be notified to **NGET** without delay by the relevant **BM Participant** (or the relevant person on its behalf). Implementation of this notification should normally be achieved by the submission of revisions to the **Export and Import Limits** in accordance with BC2.5.3 below.

BC2.5.2 Synchronising and De-Synchronising times

BC2.5.2.1 The **Final Physical Notification Data** provides indicative **Synchronising** and **De-Synchronising** times to **NGET** in respect of any **BM Unit** which is **De-Synchronising** or is anticipated to be **Synchronising** post **Gate Closure**.

Any delay of greater than five minutes to the **Synchronising** or any advancement of greater than five minutes to the **De-Synchronising** of a **BM Unit** must be notified to **NGET** without delay by the submission of a revision of the **Export and Import Limits**.

BC2.5.2.2 Except in the circumstances provided for in BC2.5.2.3, BC2.5.2.4, BC2.5.5.1 or BC2.9, no **BM Unit** (nor a **Generating Unit**) is to be **Synchronised** or **De-Synchronised** unless:-

- (a) a **Physical Notification** had been submitted to **NGET** prior to **Gate Closure** indicating that a **Synchronisation** or **De-Synchronisation** is to occur; or
- (b) **NGET** has issued a **Bid-Offer Acceptance** requiring **Synchronisation** or **De-Synchronisation** of that **BM Unit** (or a **Generating Unit**).

BC2.5.2.3 **BM Participants** must only **Synchronise** or **De-Synchronise BM Units** (or a **Generating Unit**);

- (a) at the times indicated to **NGET**, or
- (b) at times consistent with variations in output or input arising from provisions described in BC2.5.1,

(within a tolerance of +/- 5 minutes) or unless that occurs automatically as a result of **Operational Intertripping** or **Low Frequency Relay** operations or an **Ancillary Service** pursuant to an **Ancillary Services Agreement**

BC2.5.2.4 **De-Synchronisation** may also take place without prior notification to **NGET** as a result of plant breakdowns or if it is done purely on safety grounds (relating to personnel or plant). If that happens **NGET** must be informed immediately that it has taken place and a revision to **Export and Import Limits** must be submitted in accordance with BC2.5.3.3. Following any **De-Synchronisation** occurring as a result of plant failure, no **Synchronisation** of that **BM Unit** (or a **Generating Unit**) is to take place without **NGET's** agreement, such agreement not to be unreasonably withheld.

In the case of **Synchronisation** following an unplanned **De-Synchronisation** within the preceding 15 minutes, a minimum of 5 minutes notice of its intention to **Synchronise** should normally be given to **NGET** (via a revision to **Export and Import Limits**). In the case of any other unplanned **De-Synchronisation** where the **User** plans to **Synchronise** before the expiry of the current **Balancing Mechanism** period, a minimum of 15 minutes notice of **Synchronisation** should normally be given to **NGET** (via a revision to **Export and Import Limits**). In addition, the rate at which the **BM Unit** is returned to its **Physical Notification** is not to exceed the limits specified in **BC1**, Appendix 1 without **NGET's** agreement.

NGET will either agree to the **Synchronisation** or issue a **Bid-Offer Acceptance** in accordance with BC2.7 to delay the **Synchronisation**. **NGET** may agree to an earlier **Synchronisation** if **System** conditions allow.

BC2.5.2.5 Notification of Times to Network Operators

NGET will make changes to the **Synchronising** and **De-Synchronising** times available to each **Network Operator**, but only relating to **BM Units Embedded** within its **User System** and those **BM Units** directly connected to the **GB Transmission System** which **NGET** has identified under **OC2** and/or **BC1** as being those which may, in the reasonable opinion of **NGET**, affect the integrity of that **User System** and shall inform the relevant **BM Participant** that it has done so, identifying the **BM Unit** concerned.

Each **Network Operator** must notify **NGET** of any changes to its **User System Data** as soon as practicable in accordance with BC1.6.1(c).

BC2.5.3 Revisions to BM Unit Data

Following **Gate Closure** for any **Settlement Period**, no changes to the **Physical Notification**, to the **QPN** data or to **Bid-Offer Data** for that **Settlement Period** may be submitted to **NGET**.

BC2.5.3.1 At any time, any **BM Participant** (or the relevant person on its behalf) may, in respect of any of its **BM Units**, submit to **NGET** the data listed in **BC1**, Appendix 1 under the heading of **Dynamic Parameters** from the **Control Point** of its **BM Unit** to amend the data already held by **NGET** (including that previously submitted under this BC2.5.3.1) for use in preparing for and operating the **Balancing Mechanism**. The change will take effect from the time that it is received by **NGET**. For the avoidance of doubt, the **Dynamic Parameters** submitted to **NGET** under BC1.4.2(e) are not used

within the current **Operational Day**. The **Dynamic Parameters** submitted under this BC2.5.3.1 shall reasonably reflect the true current operating characteristics of the **BM Unit** and shall be prepared in accordance with **Good Industry Practice**.

Following the **Operational Intertripping** of a **System** to **Generating Unit** or a **System** to **CCGT Module**, the **BM Participant** shall as soon as reasonably practicable re-declare its MEL to reflect more accurately its output capability.

BC2.5.3.2 Revisions to **Export and Import Limits** or **Other Relevant Data** supplied (or revised) under **BC1** must be notified to **NGET** without delay as soon as any change becomes apparent to the **BM Participant** (or the relevant person on its behalf) via the **Control Point** for the **BM Unit** (or a **Generating Unit**) to ensure that an accurate assessment of **BM Unit** (or a **Generating Unit**) capability is available to **NGET** at all times. These revisions should be prepared in accordance with **Good Industry Practice** and may be submitted by use of electronic data communication facilities or by telephone.

BC2.5.3.3 Revisions to **Export and Import Limits** must be made by a **BM Participant** (or the relevant person on its behalf) via the **Control Point** in the event of any **De-Synchronisation** of a **BM Unit** (or a **Generating Unit**) in the circumstances described in BC2.5.2.4 if the **BM Unit** (or a **Generating Unit**) is no longer available for any period of time. Revisions must also be submitted in the event of plant failures causing a reduction in input or output of a **BM Unit** (or a **Generating Unit**) even if that does not lead to **De-Synchronisation**. Following the correction of a plant failure, the **BM Participant** (or the relevant person on its behalf) must notify **NGET** via the **Control Point** of a revision to the **Export and Import Limits**, if appropriate, of the **BM Unit** (or a **Generating Unit**), using reasonable endeavours to give a minimum of 5 minutes notice of its intention to return to its **Physical Notification**. The rate at which the **BM Unit** (or a **Generating Unit**) is returned to its **Physical Notification** is not to exceed the limits specified in **BC1**, Appendix 1 without **NGET's** agreement.

BC2.5.4 Operation in the absence of instructions from **NGET**

In the absence of any **Bid-Offer Acceptances**, **Ancillary Service** instructions issued pursuant to BC2.8 or **Emergency Instructions** issued pursuant to BC2.9:

- (a) as provided for in BC3, each **Synchronised Genset** producing **Active Power** must operate at all times in **Limited Frequency Sensitive Mode** (unless instructed in accordance with BC3.5.4 to operate in **Frequency Sensitive Mode**);
- (b) in the absence of any Mvar **Ancillary Service** instructions, the Mvar output of each **Synchronised Genset** should be 0 Mvar upon **Synchronisation** at the circuit-breaker where the **Genset** is **Synchronised**. For the avoidance of doubt, in the case of a **Genset** comprising of **Non-Synchronous Generating Units**, **Power Park Modules** or **DC Converters** the steady state tolerance allowed in CC.6.3.2(b) may be applied;
- (c) (i) subject to the provisions of 2.5.4(c) (ii) below, the excitation system or the voltage control system, unless otherwise agreed with **NGET**, must be operated only in its constant terminal voltage mode of operation with VAR limiters in service, with any constant **Reactive Power** output control mode or constant **Power Factor** output control mode always disabled, unless agreed otherwise with **NGET**. In the event of any change in **System** voltage, a **Generator** must not take any action to override automatic Mvar response which is produced as a result of

constant terminal voltage mode of operation of the automatic excitation control system unless instructed otherwise by **NGET** or unless immediate action is necessary to comply with **Stability Limits** or unless constrained by plant operational limits or safety grounds (relating to personnel or plant);

- (ii) In the case of all **Gensets** comprising **Non-Synchronous Generating Units, DC Converters** and **Power Park Modules** only when operating below 20 % of the **Rated MW** output, the voltage control system shall maintain the reactive power transfer at the **Grid Entry Point** (or **User System Entry Point** if **Embedded**) to 0 MVar. For the avoidance of doubt the steady state tolerance allowed in CC.6.3.2(b) may be applied. In the case of **Gensets** comprising current source **DC Converter** technology or comprising **Power Park Modules** connected to the **Total System** by a current source **DC Converter** when operating at any power output the voltage control system shall maintain the reactive power transfer at the **Grid Entry Point** (or **User System Entry Point** if **Embedded**) to 0 MVar. For the avoidance of doubt the steady state tolerance allowed in CC.6.3.2(b) may be applied.
- (d) In the absence of any Mvar **Ancillary Service** instructions, the Mvar output of each **Genset** should be 0 Mvar immediately prior to **De-Synchronisation** at the circuit-breaker where the **Genset** is **Synchronised**, other than in the case of a rapid unplanned **De-Synchronisation** or in the case of a **Genset** comprising of **Non-Synchronous Generating Units, Power Park Modules** or **DC Converters** which is operating at less than 20% of its **Rated MW** output where the requirements of BC2.5.4 (b) part (ii) apply.
- (e) a **Generator** should at all times operate its **CCGT Units** in accordance with the applicable **CCGT Module Matrix**;
- (f) in the case of a **Range CCGT Module**, a **Generator** must operate that **CCGT Module** so that power is provided at the single **Grid Entry Point** identified in the data given pursuant to PC.A.3.2.1 or at the single **Grid Entry Point** to which **NGET** has agreed pursuant to BC1.4.2(f);
- (g) in the event of the **System Frequency** being above 50.3Hz or below 49.7Hz, **BM Participants** must not commence any reasonably avoidable action to regulate the input or output of any **BM Unit** in a manner that could cause the **System Frequency** to deviate further from 50Hz without first using reasonable endeavours to discuss the proposed actions with **NGET**. **NGET** shall either agree to these changes in input or output or issue a **Bid-Offer Acceptance** in accordance with BC2.7 to delay the change.
- (h) a **Generator** should at all times operate its **Power Park Units** in accordance with the applicable **Power Park Module Availability Matrix**.

BC2.5.5 Commencement or Termination of Participation in the **Balancing Mechanism**

- BC2.5.5.1 In the event that a **BM Participant** in respect of a **BM Unit** with a **Demand Capacity** with a magnitude of less than 50MW in England and Wales or less than 5MW in Scotland or comprising **Generating Units** (as defined in the Glossary and Definitions and not limited by BC2.2) and/or **CCGT Modules** and/or **Power Park Modules** at a **Small Power Station** notifies **NGET** at least 30 days in advance that from a specified **Operational Day** it will:

- (a) no longer submit **Bid-Offer Data** under BC1.4.2(d), then with effect from that **Operational Day** that **BM Participant** no longer has to meet the requirements of BC2.5.1 nor the requirements of CC6.5.8(b) in relation to that **BM Unit**. Also, with effect from that **Operational Day**, any defaulted **Physical Notification** and defaulted **Bid-Offer Data** in relation to that **BM Unit** arising from the **Data Validation, Consistency and Defaulting Rules** will be disregarded and the provisions of BC2.5.2 will not apply;
- (b) submit **Bid-Offer Data** under BC1.4.2(d), then with effect from that **Operational Day** that **BM Participant** will need to meet the requirements of BC2.5.1 and the requirements of CC6.5.8(b) in relation to that **BM Unit**.

BC2.5.5.2 In the event that a **BM Participant** in respect of a **BM Unit** with a **Demand Capacity** with a magnitude of 50MW or greater in England and Wales or 5MW or greater in Scotland or comprising **Generating Units** (as defined in the Glossary and Definitions and not limited by BC2.2) and/or **CCGT Modules** and/or **Power Park Modules** at a **Medium Power Station** or **Large Power Station** notifies **NGET** at least 30 days in advance that from a specified **Operational Day** it will:

- (a) no longer submit **Bid-Offer Data** under BC1.4.2(d), then with effect from that **Operational Day** that **BM Participant** no longer has to meet the requirements of CC6.5.8(b) in relation to that **BM Unit**; Also, with effect from that **Operational Day**, any defaulted **Bid-Offer Data** in relation to that **BM Unit** arising from the **Data Validation, Consistency and Defaulting Rules** will be disregarded;
- (b) submit **Bid-Offer Data** under BC1.4.2(d), then with effect from that **Operational Day** that **BM Participant** will need to meet the requirements of CC6.5.8(b) in relation to that **BM Unit**.

BC2.6 COMMUNICATIONS

Electronic communications are always conducted in GMT. However, the input of data and display of information to **Users** and **NGET** and all other communications are conducted in London time.

BC2.6.1 Normal Communication with Control Points

- (a) With the exception of BC2.6.1(c) below, **Bid-Offer Acceptances** and **Ancillary Service** instructions shall be given by automatic logging device and will be given to the **Control Point** for the **BM Unit**. For all **Planned Maintenance Outages** the provisions of BC2.6.5 will apply. For **Generating Units** communications under **BC2** shall be by telephone unless otherwise agreed by **NGET** and the **User**.
- (b) **Bid-Offer Acceptances** and **Ancillary Service** instructions must be formally acknowledged immediately by the **BM Participant** (or the relevant person on its behalf) via the **Control Point** for the **BM Unit** or **Generating Unit** in respect of that **BM Unit** or that **Generating Unit**. The acknowledgement and subsequent confirmation or rejection, within two minutes of receipt, is normally given electronically by automatic logging device. If no confirmation or rejection is received by **NGET** within two minutes of the issue of the **Bid-Offer Acceptance**, then **NGET** will contact the **Control Point** for the **BM Unit** by telephone to

determine the reason for the lack of confirmation or rejection. Any rejection must be given in accordance with BC2.7.3 or BC2.8.3.

- (c) In the event of a failure of the logging device or a **NGET** computer system outage, **Bid-Offer Acceptances** and instructions will be given, acknowledged, and confirmed or rejected by telephone. The provisions of BC2.9.7 are also applicable.
- (d) In the event that in carrying out the **Bid-Offer Acceptances** or providing the **Ancillary Services**, or when operating at the level of the **Final Physical Notification Data** as provided in BC2.5.1, an unforeseen problem arises, caused on safety grounds (relating to personnel or plant), **NGET** must be notified without delay by telephone.
- (e) The provisions of BC2.5.3 are also relevant.
- (f) Submissions of revised Mvar capability may be made by facsimile transmission, using the format given in Appendix 3 to **BC2**.
- (g) Communication will normally be by telephone for any purpose other than **Bid- Offer Acceptances**, in relation to **Ancillary Services** or for revisions of Mvar Data.
- (h) Submissions of revised availability of **Frequency Sensitive Mode** may be made by facsimile transmission, using the format given in Appendix 4 to **BC2**. This process should only be used for technical restrictions to the availability of **Frequency Sensitive Mode**.

BC2.6.2 Communication with **Control Points** in Emergency Circumstances

NGET will issue **Emergency Instructions** direct to the **Control Point** for each **BM Unit** [or **Generating Unit**] in **Great Britain**. **Emergency Instructions** to a **Control Point** will normally be given by telephone (and will include an exchange of operator names).

BC2.6.3 Communication with **Network Operators** in Emergency Circumstances

NGET will issue **Emergency Instructions** direct to the **Network Operator** at each **Control Centre** in relation to special actions and **Demand Control**. **Emergency Instructions** to a **Network Operator** will normally be given by telephone (and will include an exchange of operator names). **OC6** contains further provisions relating to **Demand Control** instructions.

BC2.6.4 Communication with **Externally Interconnected System Operators** in Emergency Circumstances

NGET will issue **Emergency Instructions** directly to the **Externally Interconnected System Operator** at each **Control Centre**. **Emergency Instructions** to an **Externally Interconnected System Operator** will normally be given by telephone (and will include an exchange of operator names).

BC2.6.5 Communications during planned outages of electronic data communication facilities

Planned Maintenance Outages will normally be arranged to take place during periods of low data transfer activity. Upon any such **Planned Maintenance Outage** in relation to a post **Gate Closure** period:-

- (a) **BM Participants** should operate in relation to any period of time in accordance with the **Physical Notification** prevailing at **Gate Closure** current at the time of the start of the **Planned Maintenance Outage** in relation to each such period of time. Such operation shall be subject to the provisions of BC2.5.1, which will apply as if set out in this BC2.6.5. No further submissions of **BM Unit Data** (other than data specified in BC1.4.2(c) and BC1.4.2(e)) should be attempted or **Generating Unit Data**. Plant failure or similar problems causing significant deviation from **Physical Notification** should be notified to **NGET** by the submission of a revision to **Export and Import Limits** in relation to the **BM Unit** or **Generating Unit** so affected;
- (b) during the outage, revisions to the data specified in BC1.4.2(c) and BC1.4.2(e) may be submitted. Communication between **Users' Control Points** and **NGET** during the outage will be conducted by telephone;
- (c) **NGET** will issue **Bid-Offer Acceptances** by telephone; and
- (d) no data will be transferred from **NGET** to the **BMRA** until the communication facilities are re-established.
- (e) The provisions of BC2.9.7 may also be relevant.

BC2.7 **BID-OFFER ACCEPTANCES**

BC2.7.1 Acceptance of bids and offers by **NGET**

Bid-Offer Acceptances may be issued to the **Control Point** at any time following **Gate Closure**. Any **Bid-Offer Acceptance** will be consistent with the **Dynamic Parameters, QPNs, Export and Import Limits, and Joint BM Unit Data** of the **BM Unit** in so far as the **Balancing Mechanism** timescales will allow (see BC2.7.2).

- (a) **NGET** is entitled to assume that each **BM Unit** is available in accordance with the **BM Unit Data** submitted unless and until it is informed of any changes.
- (b) **Bid-Offer Acceptances** sent to the **Control Point** will specify the data necessary to define a MW profile to be provided (ramp rate break-points are not normally explicitly sent to the **Control Point**) and to be achieved consistent with the respective **BM Unit's Export and Import Limits, QPNs** and **Joint BM Unit Data** provided or modified under **BC1** or **BC2**, and **Dynamic Parameters** given under BC2.5.3 or, if agreed with the relevant **User**, such rate within those **Dynamic Parameters** as is specified by **NGET** in the **Bid-Offer Acceptances**.
- (c) All **Bid-Offer Acceptances** will be deemed to be at the current "**Target Frequency**", namely where a **Genset** is in **Frequency Sensitive Mode** they refer to target output at **Target Frequency**.
- (d) The form of and terms to be used by **NGET** in issuing **Bid-Offer Acceptances** together with their meanings are set out in Appendix 1 in the form of a non-exhaustive list of examples.

BC2.7.2 Consistency with Export and Import Limits, QPNs and Dynamic Parameters

- (a) **Bid-Offer Acceptances** will be consistent with the **Export and Import Limits, QPNs, and Joint BM Unit Data** provided or modified under **BC1** or **BC2** and the **Dynamic Parameters** provided or modified under **BC2**. **Bid-Offer Acceptances** may also recognise **Other Relevant Data** provided or modified under **BC1** or **BC2**
- (b) In the case of consistency with **Dynamic Parameters** this will be limited to the time until the end of the **Settlement Period** for which **Gate Closure** has most recently occurred. If **NGET** intends to issue a **Bid-Offer Acceptance** covering a period after the end of the **Settlement Period** for which **Gate Closure** has most recently occurred, based upon the then submitted **Dynamic Parameters, QPN's, Export and Import Limits, Bid-Offer Data** and **Joint BM Unit Data** applicable to that period, **NGET** will indicate this to the **BM Participant** at the **Control Point** for the **BM Unit**. The intention will then be reflected in the issue of a **Bid-Offer Acceptance** to return the **BM Unit** to its previously notified **Physical Notification** after the relevant **Gate Closure** provided the submitted data used to formulate this intention has not changed and subject to **System** conditions which may affect that intention. Subject to that, assumptions regarding **Bid-Offer Acceptances** may be made by **BM Participants** for **Settlement Periods** for which **Gate Closure** has not yet occurred when assessing consistency with **Dynamic Parameters** in **Settlement Periods** for which **Gate Closure** has occurred. If no such subsequent **Bid-Offer Acceptance** is issued, the original **Bid-Offer Acceptance** will include an instantaneous return to **Physical Notification** at the end of the **Balancing Mechanism** period.

BC2.7.3 Confirmation and Rejection of Acceptances

Bid-Offer Acceptances may only be rejected by a **BM Participant** :-

- (a) on safety grounds (relating to personnel or plant) as soon as reasonably possible and in any event within five minutes; or
- (b) because they are not consistent with the **Export and Import Limits, QPNs, Dynamic Parameters** or **Joint BM Unit Data** applicable at the time of issue of the **Bid-Offer Acceptance**.

A reason must always be given for rejection by telephone.

Where a **Bid-Offer Acceptance** is not confirmed within two minutes or is rejected, **NGET** will seek to contact the **Control Point** for the **BM Unit**. **NGET** must then, within 15 minutes of issuing the **Bid-Offer Acceptance**, withdraw the **Bid-Offer Acceptance** or log the **Bid-Offer Acceptance** as confirmed. **NGET** will only log a rejected **Bid-Offer Acceptance** as confirmed following discussion and if the reason given is, in **NGET's** reasonable opinion, not acceptable and **NGET** will inform the **BM Participant** accordingly.

BC2.7.4 Action Required from **BM Participants**

- (a) Each **BM Participant** in respect of its **BM Units** will comply in accordance with BC2.7.1 with all **Bid-Offer Acceptances** given by **NGET** with no more than the delay allowed for by the **Dynamic Parameters** unless the **BM Unit** has given notice to **NGET** under the provisions of BC2.7.3 regarding non-acceptance of a **Bid-Offer Acceptance**.
- (b) Where a **BM Unit's** input or output changes in accordance with a **Bid-Offer Acceptance** issued under BC2.7.1, such variation does not need to be notified to **NGET** in accordance with BC2.5.1.
- (c) In the event that while carrying out the **Bid-Offer Acceptance** an unforeseen problem arises caused by safety reasons (relating to personnel or plant), **NGET** must be notified immediately by telephone and this may lead to revision of **BM Unit Data** in accordance with BC2.5.3

BC2.7.5 Additional Action Required from **Generators**

- (a) When complying with **Bid-Offer Acceptances** for a **CCGT Module** a **Generator** will operate its **CCGT Units** in accordance with the applicable **CCGT Module Matrix**.
- (b) When complying with **Bid-Offer Acceptances** for a **CCGT Module** which is a **Range CCGT Module**, a **Generator** must operate that **CCGT Module** so that power is provided at the single **Grid Entry Point** identified in the data given pursuant to PC.A.3.2.1 or at the single **Grid Entry Point** to which **NGET** has agreed pursuant to BC1.4.2 (f).
- (c) On receiving a new MW **Bid-Offer Acceptance**, no tap changing shall be carried out to change the Mvar output unless there is a new Mvar **Ancillary Service** instruction issued pursuant to BC2.8.
- (d) When complying with **Bid-Offer Acceptances** for a **Power Park Module** a **Generator** will operate its **Power Park Units** in accordance with the applicable **Power Park Module Availability Matrix**.

BC2.8 **ANCILLARY SERVICES**

This section primarily covers the call-off of **System Ancillary Services**. The provisions relating to **Commercial Ancillary Services** will normally be covered in the relevant **Ancillary Services Agreement**.

BC2.8.1 Call-off of **Ancillary Services** by **NGET**

- (a) **Ancillary Service** instructions may be issued at any time.
- (b) **NGET** is entitled to assume that each **BM Unit** (or **Generating Unit**) is available in accordance with the **BM Unit Data** (or the **Generating Unit Data**) and data contained in the **Ancillary Services Agreement** unless and until it is informed of any changes.
- (c) **Frequency** control instructions may be issued in conjunction with, or separate from, a **Bid-Offer Acceptance**.

- (d) The form of and terms to be used by **NGET** in issuing **Ancillary Service** instructions together with their meanings are set out in Appendix 2 in the form of a non-exhaustive list of examples including **Reactive Power** and associated instructions.
- (e) In the case of **Generating Units** that do not form part of a **BM Unit** any change in **Active Power** as a result of, or required to enable, the provision of an **Ancillary Service** will be dealt with as part of that **Ancillary Service Agreement** and/or provisions under the **CUSC**.
- (f) A **System to Generator Operational Intertripping Scheme** will be armed in accordance with BC2.10.2(a)

BC2.8.2 Consistency with **Export and Import Limits, QPNs** and **Dynamic Parameters**

Ancillary Service instructions will be consistent with the **Export and Import Limits, QPNs**, and **Joint BM Unit Data** provided or modified under **BC1** or **BC2** and the **Dynamic Parameters** provided or modified under **BC2**. **Ancillary Service** instructions may also recognise **Other Relevant Data** provided or modified under **BC1** or **BC2**

BC2.8.3 Rejection of **Ancillary Service** instructions

- (a) **Ancillary Service** instructions may only be rejected, by automatic logging device or by telephone, on safety grounds (relating to personnel or plant) or because they are not consistent with the applicable **Export and Import Limits, QPNs, Dynamic Parameters, Joint BM Unit Data, Other Relevant Data** or data contained in the **Ancillary Services Agreement** and a reason must be given immediately for non-acceptance.
- (b) The issue of **Ancillary Service** instructions for **Reactive Power** will be made with due regard to any resulting change in **Active Power** output. The instruction may be rejected if it conflicts with any **Bid-Offer Acceptance** issued in accordance with BC2.7 or with the **Physical Notification**.
- (c) Where **Ancillary Service** instructions relating to **Active Power** and **Reactive Power** are given together, and to achieve the **Reactive Power** output would cause the **BM Unit** to operate outside **Dynamic Parameters** as a result of the **Active Power** instruction being met at the same time, then the timescale of implementation of the **Reactive Power** instruction may be extended to be no longer than the timescale for implementing the **Active Power** instruction but in any case to achieve the **Mvar Ancillary Service** instruction as soon as possible.

BC2.8.4 Action Required from **BM Units**

- (a) Each **BM Unit** (or **Generating Unit**) will comply in accordance with BC2.8.1 with all **Ancillary Service** instructions relating to **Reactive Power** properly given by **NGET** within 2 minutes or such longer period as **NGET** may instruct, and all other **Ancillary Service** instructions without delay, unless the **BM Unit** or **Generating Unit** has given notice to **NGET** under the provisions of BC2.8.3 regarding non-acceptance of **Ancillary Service** instructions.

- (b) Each **BM Unit** may deviate from the profile of its **Final Physical Notification Data**, as modified by any **Bid-Offer Acceptances** issued in accordance with BC2.7.1, only as a result of responding to **Frequency** deviations when operating in **Frequency Sensitive Mode** in accordance with the **Ancillary Services Agreement**.
- (c) Each **Generating Unit** that does not form part of a **BM Unit** may deviate from the profile of its **Final Physical Notification Data** where agreed by **NGET** and the **User**, including but not limited to, as a result of providing an **Ancillary Service** in accordance with the **Ancillary Service Agreement**.
- (d) In the event that while carrying out the **Ancillary Service** instructions an unforeseen problem arises caused by safety reasons (relating to personnel or plant), **NGET** must be notified immediately by telephone and this may lead to revision of **BM Unit Data** or **Generating Unit Data** in accordance with BC2.5.3.

BC2.9 EMERGENCY CIRCUMSTANCES

BC2.9.1 Emergency Actions

BC2.9.1.1 In certain circumstances (as determined by **NGET** in its reasonable opinion) it will be necessary, in order to preserve the integrity of the **GB Transmission System** and any synchronously connected **External System**, for **NGET** to issue **Emergency Instructions**. In such circumstances, it may be necessary to depart from normal **Balancing Mechanism** operation in accordance with BC2.7 in issuing **Bid-Offer Acceptances**. **BM Participants** must also comply with the requirements of **BC3**.

BC2.9.1.2 Examples of circumstances that may require the issue of **Emergency Instructions** include:-

- (a) **Events** on the **GB Transmission System** or the **System** of another **User**; or
- (b) the need to maintain adequate **System** and **Localised NRAPM** in accordance with BC2.9.4 below; or
- (c) the need to maintain adequate frequency sensitive **Gensets** in accordance with BC2.9.5 below; or
- (d) the need to implement **Demand Control** in accordance with OC6; or
- (e) (i) the need to invoke the **Black Start** process or the **Re-Synchronisation of De-Synchronised Island** process in accordance with OC9; or
(ii) the need to request provision of a **Maximum Generation Service**.

BC2.9.1.3 In the case of **BM Units** and **Generating Units** in **Great Britain**, **Emergency Instructions** will be issued by **NGET** direct to the **User** at the **Control Point** for the **BM Unit** or **Generating Unit** and may require an action or response which is outside its **Other Relevant Data**, **QPNs**, or **Export and Import Limits** submitted under **BC1**, or revised under **BC1** or **BC2**, or **Dynamic Parameters** submitted or revised under **BC2**.

BC2.9.1.4 In the case of a **Network Operator** or an **Externally Interconnected System Operator**, **Emergency Instructions** will be issued to its **Control Centre**.

BC2.9.2 Implementation of Emergency Instructions

BC2.9.2.1 **Users** will respond to **Emergency Instructions** issued by **NGET** without delay and using all reasonable endeavours to so respond. **Emergency Instructions** may only be rejected by an **User** on safety grounds (relating to personnel or plant) and this must be notified to **NGET** immediately by telephone.

BC2.9.2.2 **Emergency Instructions** will always be prefixed with the words "This is an **Emergency Instruction**" except in the case of **Maximum Generation Service** instructed by electronic data communication facilities where the instruction will be issued in accordance with the provisions of the **Maximum Generation Service Agreement**.

BC2.9.2.3 In all cases under this BC2.9 except BC2.9.1.2 (e) where **NGET** issues an **Emergency Instruction** to a **BM Participant** which is not rejected under BC2.9.2.1, the **Emergency Instruction** shall be treated as a **Bid-Offer Acceptance**. For the avoidance of doubt, any **Emergency Instruction** issued to a **Network Operator** or to an **Externally Interconnected System Operator** or in respect of a **Generating Unit** that does not form part of a **BM Unit**, will not be treated as a **Bid-Offer Acceptance**.

BC2.9.2.4 In the case of BC2.9.1.2 (e) (ii) where **NGET** issues an **Emergency Instruction** pursuant to a **Maximum Generation Service Agreement** payment will be dealt with in accordance with the **CUSC** and the **Maximum Generation Service Agreement**.

BC2.9.3 Examples of Emergency Instructions

BC2.9.3.1 In the case of a **BM Unit** or a **Generating Unit**, **Emergency Instructions** may include an instruction for the **BM Unit** or the **Generating Unit** to operate in a way that is not consistent with the **Dynamic Parameters**, **QPNs** and/or **Export and Import Limits**.

BC2.9.3.2 In the case of a **Generator**, **Emergency Instructions** may include:

- (a) an instruction to trip one or more **Gensets** (excluding **Operational Intertripping**); or
- (b) an instruction to trip **Mills** or to **Part Load** a **Generating Unit** (as defined in the Glossary and Definitions and not limited by BC2.2); or
- (c) an instruction to **Part Load** a **CCGT Module** or **Power Park Module**; or
- (d) an instruction for the operation of **CCGT Units** within a **CCGT Module** (on the basis of the information contained within the **CCGT Module Matrix**) when emergency circumstances prevail (as determined by **NGET** in **NGET's** reasonable opinion); or
- (e) an instruction to generate outside normal parameters, as allowed for in 4.2 of the **CUSC**; or
- (f) an instruction for the operation of **Generating Units** within a **Cascade Hydro Scheme** (on the basis of the additional information supplied in relation to individual **Generating Units**) when emergency circumstances prevail (as determined by **NGET** in **NGET's** reasonable opinion); or

- (g) an instruction for the operation of a **Power Park Module** (on the basis of the information contained within the **Power Park Module Availability Matrix**) when emergency circumstances prevail (as determined by **NGET** in **NGET's** reasonable opinion).

BC2.9.3.3 Instructions to **Network Operators** relating to the **Operational Day** may include:

- (a) a requirement for **Demand** reduction and disconnection or restoration pursuant to **OC6**;
- (b) an instruction to effect a load transfer between **Grid Supply Points**;
- (c) an instruction to switch in a **System to Demand Intertrip Scheme**;
- (d) an instruction to split a network;
- (e) an instruction to disconnect an item of **Plant** or **Apparatus** from the **System**.

BC2.9.4 Maintaining adequate **System** and **Localised NRAPM (Negative Reserve Active Power Margin)**

BC2.9.4.1 Where **NGET** is unable to satisfy the required **System NRAPM** or **Localised NRAPM** by following the process described in BC1.5.5, **NGET** will issue an **Emergency Instruction** to exporting **BM Units** for **De-Synchronising** on the basis of **Bid-Offer Data** submitted to **NGET** in accordance with BC1.4.2(d).

BC2.9.4.2 In the event that **NGET** is unable to differentiate between exporting **BM Units** according to **Bid-Offer Data**, **NGET** will instruct a **BM Participant** to **Shutdown** a specified exporting **BM Unit** for such period based upon the following factors:

- (a) effect on power flows (resulting in the minimisation of transmission losses);
- (b) reserve capability;
- (c) **Reactive Power** worth;
- (d) **Dynamic Parameters**;
- (e) in the case of **Localised NRAPM**, effectiveness of output reduction in the management of the **System Constraint**.

BC2.9.4.3 Where **NGET** is still unable to differentiate between exporting **BM Units**, having considered all the foregoing, **NGET** will decide which exporting **BM Unit** to **Shutdown** by the application of a quota for each **BM Participant** in the ratio of each **BM Participant's Physical Notifications**.

BC2.9.4.4 Other than as provided in BC2.9.4.5 and BC2.9.4.6 below, in determining which exporting **BM Units** to **De-Synchronise** under this BC2.9.4, **NGET** shall not consider in such determination (and accordingly shall not instruct to **De-Synchronise**) any **Generating Unit** (as defined in the Glossary and Definitions and not limited by BC2.2) within an **Existing Gas Cooled Reactor Plant**.

BC2.9.4.5 **NGET** shall be permitted to instruct a **Generating Unit** (as defined in the Glossary and Definitions and not limited by BC2.2) within an **Existing AGR Plant** to **De-Synchronise** if the relevant **Generating Unit** within the **Existing AGR Plant** has

failed to offer to be flexible for the relevant instance at the request of **NGET** within the **Existing AGR Plant Flexibility Limit**.

BC2.9.4.6 Notwithstanding the provisions of BC2.9.4.5 above, if the level of **System NRAPM** (taken together with **System** constraints) or **Localised NRAPM** is such that it is not possible to avoid instructing a **Generating Unit** (as defined in the Glossary and Definitions and not limited by BC2.2) within an **Existing Magnox Reactor Plant** and/or an **Existing AGR Plant** whether or not it has met requests within the **Existing AGR Flexibility Limit** to **De-Synchronise NGET** may, provided the power flow across each **External Interconnection** is either at zero or results in an export of power from the **Total System**, so instruct a **Generating Unit** (as defined in the Glossary and Definitions and not limited by BC2.2) within an **Existing Magnox Reactor Plant** and/or an **Existing AGR Plant** to **De-Synchronise** in the case of **System NRAPM**, in all cases and in the case of **Localised NRAPM**, when the power flow would have a relevant effect.

BC2.9.4.7 When instructing exporting **BM Units** which form part of an **On-Site Generator Site** to reduce generation under this BC2.9.4, **NGET** will not issue an instruction which would reduce generation below the reasonably anticipated **Demand** of the **On-Site Generator Site**. For the avoidance of doubt, it should be noted that the term "**On-Site Generator Site**" only relates to Trading Units which have fulfilled the Class 1 or Class 2 requirements.

BC2.9.5 Maintaining adequate Frequency Sensitive Generation

BC2.9.5.1 If, post **Gate Closure**, **NGET** determines, in its reasonable opinion, from the information then available to it (including information relating to **Generating Unit** (as defined in the Glossary and Definitions and not limited by BC2.2) breakdown) that the number of and level of **Primary**, **Secondary** and **High Frequency Response** available from **Gensets** (other than those units within **Existing Gas Cooled Reactor Plant**, which are permitted to operate in **Limited Frequency Sensitive Mode** at all times under BC3.5.3) available to operate in **Frequency Sensitive Mode** is such that it is not possible to avoid **De-Synchronising Existing Gas Cooled Reactor Plant** then provided that:

- (a) there are (or, as the case may be, that **NGET** anticipates, in its reasonable opinion, that at the time that the instruction is to take effect there will be) no other **Gensets** generating and exporting on to the **Total System** which are not operating in **Frequency Sensitive Mode** (or which are operating with only a nominal amount in terms of level and duration) (unless, in **NGET's** reasonable opinion, necessary to assist the relief of **System** constraints or necessary as a result of other **System** conditions); and
- (b) the power flow across each **External Interconnection** is (or, as the case may be, is anticipated to be at the time that the instruction is to take effect) either at zero or result in an export of power from the **Total System**,

then **NGET** may instruct such of the **Existing Gas Cooled Reactor Plant** to **De-Synchronise** as it is, in **NGET's** reasonable opinion, necessary to **De-Synchronise** and for the period for which the **De-Synchronising** is, in **NGET's** reasonable opinion, necessary.

BC2.9.5.2 If in **NGET's** reasonable opinion it is necessary for both the procedure in BC2.9.4 and that set out in BC2.9.5.1 to be followed in any given situation, the procedure in BC2.9.4 will be followed first, and then the procedure set out in BC2.9.5.1. For the avoidance of doubt, nothing in this sub-paragraph shall prevent either procedure from being followed separately and independently of the other.

BC2.9.6

Emergency Assistance to and from External Systems

- (a) An **Externally Interconnected System Operator** (in its role as operator of the **External System**) may request that **NGET** takes any available action to increase the **Active Energy** transferred into its **External System**, or reduce the **Active Energy** transferred into the **GB Transmission System** by way of emergency assistance if the alternative is to instruct a demand reduction on all or part of its **External System** (or on the system of an **Interconnector User** using its **External System**). Such request must be met by **NGET** providing this does not require a reduction of **Demand** on the **GB Transmission System**, or lead to a reduction in security on the **GB Transmission System**.
- (b) **NGET** may request that an **Externally Interconnected System Operator** takes any available action to increase the **Active Energy** transferred into the **GB Transmission System**, or reduce the **Active Energy** transferred into its **External System** by way of emergency assistance if the alternative is to instruct a **Demand** reduction on all or part of the **GB Transmission System**. Such request must be met by the **Externally Interconnected System Operator** providing this does not require a reduction of **Demand** on its **External System** (or on the system of **Interconnector Users** using its **External System**), or lead to a reduction in security on such **External System** or system.

BC2.9.7

Unplanned outages of electronic communication and computing facilities

BC2.9.7.1

In the event of an unplanned outage of the electronic data communication facilities or of **NGET's** associated computing facilities or in the event of a **Planned Maintenance Outage** lasting longer than the planned duration, in relation to a post-**Gate Closure** period **NGET** will, as soon as it is reasonably able to do so, issue a **NGET Computing System Failure** notification by telephone or such other means agreed between **Users** and **NGET** indicating the likely duration of the outage.

BC2.9.7.2

During the period of any such outage, the following provisions will apply:

- (a) **NGET** will issue further **NGET Computing System Failure** notifications by telephone or such other means agreed between **Users** and **NGET** to all **BM Participants** to provide updates on the likely duration of the outage;
- (b) **BM Participants** should operate in relation to any period of time in accordance with the **Physical Notification** prevailing at **Gate Closure** current at the time of the computer system failure in relation to each such period of time. Such operation shall be subject to the provisions of BC2.5.1, which will apply as if set out in this BC2.9.7.2. No further submissions of **BM Unit Data** or **Generating Unit Data** (other than data specified in BC1.4.2(c) (**Export and Import Limits**) and BC1.4.2(e) (**Dynamic Parameters**)) should be attempted. Plant failure or similar problems causing significant deviation from **Physical Notification** should be notified to **NGET** by telephone by the submission of a revision to **Export and Import Limits** in relation to the **BM Unit** or **Generating Unit Data** so affected;
- (c) Revisions to **Export and Import Limits** and to **Dynamic Parameters** should be notified to **NGET** by telephone and will be recorded for subsequent use;
- (d) **NGET** will issue **Bid-Offer Acceptances** by telephone which will be recorded for subsequent use;

- (e) No data will be transferred from **NGET** to the **BMRA** until the communication facilities are re-established.

BC2.9.7.3 **NGET** will advise **BM Participants** of the withdrawal of the **NGET** Computing System Failure notification following the re-establishment of the communication facilities.

BC2.10 OTHER OPERATIONAL INSTRUCTIONS AND NOTIFICATIONS

BC2.10.1 **NGET** may, from time to time, need to issue other instructions or notifications associated with the operation of the **GB Transmission System**.

BC2.10.2 Such instructions or notifications may include:

- (a) Intertrips
an instruction to arm or disarm an **Operational Intertripping** scheme;
- (b) Tap Positions
a request for a **Genset** step-up transformer tap position (for security assessment);
- (c) Tests
an instruction to carry out tests as required under **OC5**, which may include the issue of an instruction regarding the operation of **CCGT Units** within a **CCGT Module** at a **Large Power Station**;
- (d) Future **BM Unit** Requirements
a reference to any implications for future **BM Unit** requirements and the security of the **GB Transmission System**, including arrangements for change in output to meet post fault security requirements;
- (e) Changes to **Target Frequency**
a notification of a change in **Target Frequency**, which will normally only be 49.95, 50.00, or 50.05Hz but in exceptional circumstances as determined by **NGET** in its reasonable opinion, may be 49.90 or 50.10Hz.

BC2.10.3 Where an instruction or notification under BC2.10.2 (c) or (d) results in a change to the input or output level of the **BM Unit** then **NGET** shall issue a **Bid-Offer Acceptance** or **Emergency Instruction** as appropriate.

BC2.11 LIAISON WITH GENERATORS FOR RISK OF TRIP AND AVR TESTING

BC2.11.1 A **Generator** at the **Control Point** for any of its **Large Power Stations** may request **NGET's** agreement for one of the **Gensets** at that **Power Station** to be operated under a risk of trip. **NGET's** agreement will be dependent on the risk to the **GB Transmission System** that a trip of the **Genset** would constitute.

- (a) Each **Generator** at the **Control Point** for any of its **Large Power Stations** will operate its **Synchronised Gensets** (excluding **Power Park Modules**) with:
 - (i) **AVRs** in constant terminal voltage mode with VAR limiters in service at all times. **AVR** constant **Reactive Power** or **Power Factor** mode should, if installed, be disabled; and

(ii) its generator step-up transformer tap changer selected to manual mode,
unless released from this obligation in respect of a particular **Genset** by **NGET**.

- (b) Each **Generator** at the **Control Point** for any of its **Large Power Stations** will operate its **Power Park Modules** with a **Completion Date** before 1st January 2006 at unity power factor at the **Grid Entry Point** (or **User System Entry Point** if **Embedded**).
- (c) Each **Generator** at the **Control Point** for any of its **Large Power Stations** will operate its **Power Park Modules** with a **Completion Date** on or after 1st January 2006 in voltage control mode at the **Grid Entry Point** (or **User System Entry Point** if **Embedded**). Constant **Reactive Power** or **Power Factor** mode should, if installed, be disabled.
- (d) Where a **Power System Stabiliser** is fitted as part of the excitation system or voltage control system of a **Genset**, it requires on-load commissioning which must be witnessed by **NGET**. Only when the performance of the **Power System Stabiliser** has been approved by **NGET** shall it be switched into service by a **Generator** and then it will be kept in service at all times unless otherwise agreed with **NGET**. Further reference is made to this in CC.6.3.8.

BC2.11.3 A **Generator** at the **Control Point** for any of its **Power Stations** may request **NGET's** agreement for one of its **Gensets** at that **Power Station** to be operated with the **AVR** in manual mode, or **Power System Stabiliser** switched out, or VAR limiter switched out. **NGET's** agreement will be dependent on the risk that would be imposed on the **GB Transmission System** and any **User System**. Provided that in any event a **Generator** may take such action as is reasonably necessary on safety grounds (relating to personnel or plant) .

BC2.12 LIAISON WITH EXTERNALLY INTERCONNECTED SYSTEM OPERATORS

BC2.12.1 Co-ordination role of Externally Interconnected System Operators

- (a) The **Externally Interconnected System Operator** will act as the **Control Point** for **Bid-Offer Acceptances** on behalf of **Interconnector Users** and will co-ordinate instructions relating to **Ancillary Services** and **Emergency Instructions** on behalf of **Interconnector Users** using its **External System** in respect of each **Interconnector User's BM Units**.
- (b) **NGET** will issue **Bid-Offer Acceptances** and instructions for **Ancillary Services** relating to **Interconnector Users' BM Units** to each **Externally Interconnected System Operator** in respect of each **Interconnector User** using its **External System**.
- (c) If, as a result of a reduction in the capability (in MW) of the **External Interconnection**, the total of the **Physical Notifications** and **Bid-Offer Acceptances** issued for the relevant period using that **External Interconnection**, as stated in the **BM Unit Data** exceeds the reduced capability (in MW) of the respective **External Interconnection** in that period then **NGET** shall notify the **Externally Interconnected System Operator** accordingly. The **Externally Interconnected System Operator** should seek a revision of **Export and Import Limits** from one or more of its **Interconnector**

Users for the remainder of the **Balancing Mechanism** period during which **Physical Notifications** cannot be revised.

Appendix 1 – Form of Bid-Offer Acceptances

BC2.A.1.1 This Appendix describes the forms of **Bid-Offer Acceptances**. As described in BC2.6.1 **Bid-Offer Acceptances** are normally given by an automatic logging device, but in the event of failure of the logging device, **Bid-Offer Acceptances** will be given by telephone.

BC2.A.1.2 For each **BM Unit** the **Bid-Offer Acceptance** will consist of a series of MW figures and associated times.

BC2.A.1.3 The **Bid-Offer Acceptances** relating to **CCGT Modules** will assume that the **CCGT Units** within the **CCGT Module** will operate in accordance with the **CCGT Module Matrix**, as required by **BC1**. The **Bid-Offer Acceptances** relating to **Cascade Hydro Schemes** will assume that the **Generating Unit** forming part of the **Cascade Hydro Scheme** will operate, where submitted, in accordance with the **Cascade Hydro Scheme Matrix** submitted under **BC1**.

BC2.A.1.4 BID-OFFER ACCEPTANCES GIVEN BY AUTOMATIC LOGGING DEVICE.

(a) The complete form of the **Bid-Offer Acceptance** is given in the EDL Message Interface Specification which can be made available to **Users** on request.

(b) **Bid-Offer Acceptances** will normally follow the form:

- (i) **BM Unit** Name
- (ii) Instruction Reference Number
- (iii) Time of instruction
- (iv) Type of instruction
- (v) **BM Unit Bid-Offer Acceptance** number
- (vi) Number of MW/Time points making up instruction (minimum 2, maximum 5)
- (vii) MW value and Time value for each point identified in (vi)

The times required in the instruction are input and displayed in London time, but communicated electronically in GMT.

BC2.A.1.5 BID-OFFER ACCEPTANCES GIVEN BY TELEPHONE

(a) All run-up/run-down rates will be assumed to be constant and consistent with **Dynamic Parameters**. Each **Bid-Offer Acceptance** will, wherever possible, be kept simple, drawing as necessary from the following forms and BC2.7

(b) **Bid-Offer Acceptances** given by telephone will normally follow the form:

- (i) an exchange of operator names;
- (ii) **BM Unit** Name;
- (iii) Time of instruction;
- (iv) Type of instruction;
- (v) Number of MW/Time points making up instruction (minimum 2, maximum 5)
- (vi) MW value and Time value for each point identified in (v)

The times required in the instruction are expressed in London time.

For example, for a BM Unit ABCD-1 acceptance logged with a start time at 1400 hours and with a FPN at 300MW:

“BM Unit ABCD-1 Bid-Offer Acceptance timed at 1400 hours. Acceptance consists of 4 MW/Time points as follows:

300MW at 1400 hours
400MW at 1415 hours
400MW at 1450 hours
300MW at 1500 hours”

BC2.A.1.6 SUBMISSION OF **BID-OFFER ACCEPTANCE** DATA TO THE **BMRA**

The relevant information contained in **Bid-Offer Acceptances** issued by **NGET** will be converted into “from” and “to” MW levels and times before they are submitted to the **BMRA** by **NGET**.

Appendix 2 - Type and Form of **Ancillary Service** Instructions

BC2.A.2.1 This part of the Appendix consists of a non-exhaustive list of the forms and types of instruction for a **Genset** to provide **System Ancillary Services**. There may be other types of **Commercial Ancillary Services** and these will be covered in the relevant **Ancillary Services Agreement**. In respect of the provision of **Ancillary Services** by **Generating Units** the forms and types of instruction will be in the form of this Appendix 2 unless amended in the **Ancillary Services Agreement**.

As described in CC.8, **System Ancillary Services** consist of Part 1 and Part 2 **System Ancillary Services**.

Part 1 System Ancillary Services comprise:

- (a) **Reactive Power** supplied other than by means of synchronous or static compensators. This is required to ensure that a satisfactory **System** voltage profile is maintained and that sufficient **Reactive Power** reserves are maintained under normal and fault conditions. **Ancillary Service** instructions in relation to **Reactive Power** may include:
 - (i) Mvar Output
 - (ii) Target Voltage Levels
 - (iii) Tap Changes
 - (iv) Maximum Mvar Output ('maximum excitation')
 - (v) Maximum Mvar Absorption ('minimum excitation')
- (b) **Frequency** Control by means of **Frequency** sensitive generation. **Gensets** may be required to move to or from **Frequency Sensitive Mode** in the combinations agreed in the relevant **Ancillary Services Agreement**. They will be specifically requested to operate so as to provide **Primary Response** and/or **Secondary Response** and/or **High Frequency Response**.

Part 2 System Ancillary Services comprise:

- (c) **Frequency** Control by means of **Fast Start**.
- (d) **Black Start Capability**
- (e) **System to Generator Operational Intertripping**

BC2.A.2.2 As **Ancillary Service** instructions are not part of **Bid-Offer Acceptances** they do not need to be closed instructions and can cover any period of time, not just limited to the period of the **Balancing Mechanism**.

BC2.A.2.3 As described in BC2.6.1 **Ancillary Service** instructions are normally given by automatic logging device, but in the absence of, or in the event of failure of the logging device, instructions will be given by telephone.

BC2.A.2.4 INSTRUCTIONS GIVEN BY AUTOMATIC LOGGING DEVICE.

- (a) The complete form of the **Ancillary Service** instruction is given in the EDL Message Interface Specification which is available to **Users** on request from **NGET**.

(b) **Ancillary Service** instructions for **Frequency** Control will normally follow the form:

- (i) **BM Unit Name**
- (ii) Instruction Reference Number
- (iii) Time of instruction
- (iv) Type of instruction (REAS)
- (v) Reason Code
- (vi) Start Time

(c) **Ancillary Service** instructions for **Reactive Power** will normally follow the form:

- (i) **BM Unit Name**
- (ii) Instruction Reference Number
- (iii) Time of instruction
- (iv) Type of instruction (MVAR, VOLT or TAPP)
- (v) Target Value
- (vi) Target Time

The times required in the instruction are input and displayed in London time, but communicated electronically in GMT.

BC2.A.2.5 INSTRUCTIONS GIVEN BY TELEPHONE

(a) **Ancillary Service** instructions for **Frequency** Control will normally follow the form:

- (i) an exchange of operator names;
- (ii) **BM Unit Name**;
- (iii) Time of instruction;
- (iv) Type of instruction;
- (v) Start Time.

The times required in the instruction are expressed in London time.

For example, for **BM Unit** ABCD-1 instructed at 1400 hours to provide Primary and **High Frequency** response starting at 1415 hours:

“BM Unit ABCD-1 message timed at 1400 hours. Unit to Primary and High Frequency Response at 1415 hours”

(b) **Ancillary Service** instructions for **Reactive Power** will normally follow the form:

- (i) an exchange of operator names;
- (ii) **BM Unit Name**;
- (iii) Time of instruction;
- (iv) Type of instruction (MVAR, VOLT or TAPP)
- (v) Target Value
- (vi) Target Time.

The times required in the instruction are expressed as London time.

For example, for **BM Unit** ABCD-1 instructed at 1400 hours to provide 100Mvar by 1415 hours:

“**BM Unit ABCD-1** message timed at 1400 hours. MVAR instruction. Unit to plus 100 Mvar target time 1415 hours.”

BC2.A.2.6 **Reactive Power**

As described in BC2.A.2.4 and BC2.A.2.5 instructions for **Ancillary Services** relating to **Reactive Power** may consist of any of several specific types of instruction. The following table describes these instructions in more detail:

Instruction Name	Description	Type of Instruction
<u>Mvar Output</u>	<p>The individual Mvar output from the Genset onto the GB Transmission System at the Grid Entry Point (or onto the User System at the User System Entry Point in the case of Embedded Power Stations), namely on the higher voltage side of the generator step-up transformer. In relation to each Genset, where there is no HV indication, NGET and the Generator will discuss and agree equivalent Mvar levels for the corresponding LV indication.</p> <p>Where a Genset is instructed to a specific Mvar output, the Generator must achieve that output within a tolerance of +/-25 Mvar (for Gensets in England and Wales) or the lesser of +/-5% of rated output or 25Mvar (for Gensets in Scotland) (or such other figure as may be agreed with NGET) by tap changing on the generator step-up transformer, unless agreed otherwise. Once this has been achieved, the Generator will not tap again without prior consultation with and the agreement of NGET, on the basis that Mvar output will be allowed to vary with System conditions.</p>	MVAR
<u>Target Voltage Levels</u>	<p>Target voltage levels to be achieved by the Genset on the GB Transmission System at the Grid Entry Point (or on the User System at the User System Entry Point in the case of Embedded Power Stations, namely on the higher voltage side of the generator step-up transformer. Where a Genset is instructed to a specific target voltage, the Generator must achieve that target within a tolerance of ± 1 kV (or such other figure as may be agreed with NGET) by tap changing on the generator step-up transformer, unless agreed otherwise with NGET. In relation to each Genset, where there is no HV indication, NGET and the Generator will discuss and agree equivalent voltage levels for the corresponding LV indication.</p> <p>Under normal operating conditions, once this target voltage level has been achieved the Generator will not tap again without prior consultation with, and with the agreement of, NGET.</p> <p>However, under certain circumstances the Generator may be instructed to maintain a target voltage until otherwise instructed and this will be achieved by tap changing on the generator step-up transformer without reference to NGET.</p>	VOLT

Instruction Name	Description	Type of Instruction
<u>Tap Changes</u>	<p>Details of the required generator step-up transformer tap changes in relation to a Genset. The instruction for tap changes may be a Simultaneous Tap Change instruction, whereby the tap change must be effected by the Generator in response to an instruction from NGET issued simultaneously to relevant Power Stations. The instruction, which is normally preceded by advance notice, must be effected as soon as possible, and in any event within one minute of receipt from NGET of the instruction.</p> <p>For a Simultaneous Tap Change, change Genset generator step-up transformer tap position by one [two] taps to raise or lower (as relevant) System voltage, to be executed at time of instruction.</p>	TAPP
Maximum Mvar Output ("maximum excitation")	Under certain conditions, such as low System voltage, an instruction to maximum Mvar output at instructed MW output ("maximum excitation") may be given, and a Generator should take appropriate actions to maximise Mvar output unless constrained by plant operational limits or safety grounds (relating to personnel or plant).	
<u>Maximum Mvar Absorption ("minimum excitation")</u>	Under certain conditions, such as high System voltage, an instruction to maximum Mvar absorption at instructed MW output ("minimum excitation") may be given, and a Generator should take appropriate actions to maximise Mvar absorption unless constrained by plant operational limits or safety grounds (relating to personnel or plant).	

BC2.A.2.7 In addition, the following provisions will apply to **Reactive Power** instructions:

- (a) In circumstances where **NGET** issues new instructions in relation to more than one **BM Unit** at the same **Power Station** at the same time tapping will be carried out by the **Generator** one tap at a time either alternately between (or in sequential order, if more than two), or at the same time on, each **BM Unit**.
- (b) Where the instructions require more than two taps per **BM Unit** and that means that the instructions cannot be achieved within 2 minutes of the instruction time (or such longer period at **NGET** may have instructed), the instructions must each be achieved with the minimum of delay after the expiry of that period.
- (c) It should be noted that should **System** conditions require, **NGET** may need to instruct maximum Mvar output to be achieved as soon as possible, but (subject to the provisions of paragraph (BC2.A.2.7(b) above) in any event no later than 2 minutes after the instruction is issued.
- (d) An **Ancillary Service** instruction relating to **Reactive Power** may be given in respect of **CCGT Units** within a **CCGT Module** at a **Power Station** where running arrangements and/or **System** conditions require, in both cases where exceptional circumstances apply and connection arrangements permit.
- (e) In relation to Mvar matters, Mvar generation/output is an export onto the **System** and is referred to as "lagging Mvar", and Mvar absorption is an import from the **System** and is referred to as "leading Mvar".

- (f) It should be noted that the excitation control system constant **Reactive Power** output control mode or constant power factor output control mode will always be disabled, unless agreed otherwise with **NGET**.

Appendix 3 – Submission of Revised Mvar Capability

BC2.A.3.1 For the purpose of submitting revised Mvar data the following terms shall apply:

Full Output	In the case of a Synchronous Generating Unit (as defined in the Glossary and Definitions and not limited by BC2.2) is the MW output measured at the generator stator terminals representing the LV equivalent of the Registered Capacity at the Grid Entry Point , and in the case of a Non-Synchronous Generating Unit (excluding Power Park Units), DC Converter or Power Park Module is the Registered Capacity at the Grid Entry Point
Minimum Output	In the case of a Synchronous Generating Unit (as defined in the Glossary and Definitions and not limited by BC2.2) is the MW output measured at the generator stator terminals representing the LV equivalent of the Minimum Generation at the Grid Entry Point , and in the case of a Non-Synchronous Generating Unit (excluding Power Park Units), DC Converter or Power Park Module is the Minimum Generation at the Grid Entry Point

BC2.A.3.2 The following provisions apply to faxed submission of revised Mvar data:

- (a) The fax must be transmitted to **NGET** (to the relevant location in accordance with GC6) and must contain all the sections from the relevant part of Annexures 1 and 2 but with only the data changes set out. The "notification time" must be completed to refer to the time of transmission, where the time is expressed as London time.
- (b) Upon receipt of the fax, **NGET** will acknowledge receipt by sending a fax back to the **User**. The acknowledgement will either state that the fax has been received and is legible or will state that it (or part of it) is not legible and will request re-transmission of the whole (or part) of the fax.
- (c) Upon receipt of the acknowledging fax the **User** will, if requested, re-transmit the whole or the relevant part of the fax.
- (d) The provisions of paragraphs (b) and (c) then apply to that re-transmitted fax.

APPENDIX 3 - ANNEXURE 1



Company name **REVISED Mvar DATA**

TO: **NGET** Transmission Control Centre

Fax telephone No.

Number of pages inc. header:.....

Sent By :

Return Acknowledgement Fax to

For Retransmission or Clarification ring.....

Acknowledged by **NGET**: (Signature)

.....

Acknowledgement time and date

Legibility of FAX :

Acceptable

Unacceptable
(List pages if appropriate)

(Resend FAX)

APPENDIX 3 - ANNEXURE 2

To: **NGET** Transmission Control Centre

From : [Company Name & Location]

REVISED Mvar DATA

NOTIFICATION TIME:

HRS MINS DD MM YY . / /

GENERATING UNIT* POWER PARK MODULE DC CONVERTER	
---	--

Start Time/Date (if not effective immediately)

REACTIVE POWER CAPABILITY AT SYNCHRONOUS GENERATING UNIT STATOR TERMINAL
(at rated terminal volts) **OR AT THE CONNECTION POINT FOR OTHER GENSETS AND DC CONVERTERS**

	MW	LEAD (Mvar)	LAG (Mvar)
AT RATED MW			
AT FULL OUTPUT (MW)			
AT MINIMUM OUTPUT (MW)			

GENERATING UNIT STEP-UP TRANSFORMER DATA, WHERE APPLICABLE

TAP CHANGE RANGE (+%,-%)	TAP NUMBER RANGE

OPTIONAL INFORMATION (for Ancillary Services use only) -

REACTIVE POWER CAPABILITY AT COMMERCIAL BOUNDARY (at rated stator terminal and nominal system volts)

	LEAD (Mvar)	LAG (Mvar)
AT RATED MW		

Predicted End Time/Date (to be confirmed by redeclaration)

Redeclaration made by (Signature) _____

Generating Unit has the meaning given in the Glossary and Definitions and is not limited by BC2.2.

* For a CCGT, the redeclaration is for an individual CCGT unit and not the entire module.

Appendix 4 – Submission of availability of **Frequency Sensitive Mode**

- BC2.A.4.1. For the purpose of submitting availability of **Frequency Sensitive Mode**, this process only relates to the provision of response under the **Frequency Sensitive Mode** and does not cover the provision of response under the **Limited Frequency Sensitive Mode**.
- BC2.A.4.2. The following provisions apply to the faxed submission of the **Frequency Sensitive Mode availability**;
- (a) The fax must be transmitted to **NGET** (to the relevant location in accordance with GC6) and must contain all the sections relevant to Appendix 4 - Annexure 1 but with only the data changes set out. The “notification time” must be completed to refer to the time and date of transmission, where the time is expressed in London time.
 - (b) Upon receipt of the fax, **NGET** will acknowledge receipt by sending a fax back to the **User**. This acknowledging fax should be in the format of Appendix 4 – Annexure 1. The acknowledgement will either state that the fax has been received and is legible or will state that it (or part of it) is not legible and will request re-transmission of the whole (or part) of the fax.
 - (c) Upon receipt of the acknowledging fax the **User** will, if requested re-transmit the whole or the relevant part of the fax.
 - (d) The provisions of paragraph (b) and (c) then apply to the re-transmitted fax.
- BC2.A.4.3 The **User** shall ensure the availability of operating in the **Frequency Sensitive Mode** is restored as soon as reasonably practicable and will notify **NGET** using the format of Appendix 4 – Annexure 1. In the event of a sustained unavailability of **Frequency Sensitive Mode** **NGET** may seek to confirm compliance with the relevant requirements in the **CCs** through the process in **OC5**.

Appendix 4 – Annexure 1

To: **NGET** Transmission Control Centre
From: [Company Name and Location]

Submission of availability of Frequency Sensitive Mode

Notification Time

HRS:MIN	DD/MM/YY
__:__	__/__/__

GENERATING UNIT *	
--------------------------	--

Start Time / Date (if not effective immediately)

The above unit is unavailable / available to operate in **Frequency Sensitive Mode**.

Limited Frequency Sensitive Mode must be maintained in accordance with BC3.7.2.

Please provide brief description of reason for unavailability of **Frequency Sensitive Mode** (e.g. Testing, technical problem)

If declaring Unavailability
Predicted End Time / Date (to be confirmed by re-declaration):

Re-declaration made by (signature) _____

- For a CCGT the re-declaration is for an individual **CCGT Unit** and not the entire module

Receipt Acknowledgement from **NGET**

Legible (tick box)		Illegible (tick box)	
Explanation:			
Time:			
Date:			
Signature:			

< End of BC2 >

BALANCING CODE NO.3

FREQUENCY CONTROL PROCESS

CONTENTS

(This contents page does not form part of the Grid Code)

<u>Paragraph No/Title</u>	<u>Page Number</u>
BC3.1 INTRODUCTION.....	1
BC3.2 OBJECTIVE	1
BC3.3 SCOPE	1
BC3.4 MANAGING SYSTEM FREQUENCY	2
BC3.4.1 Statutory Requirements	2
BC3.4.2 Target Frequency	2
BC3.4.3 Electric Time.....	2
BC3.5 RESPONSE FROM GENSETS AND DC CONVERTERS AT DC CONVERTER STATIONS WHEN TRANSFERRING ACTIVE POWER TO THE TOTAL SYSTEM.....	2
BC3.5.1 Capability.....	2
BC3.5.2 Limited Frequency Sensitive Mode	3
BC3.5.3 Existing Gas Cooled Reactor Plant and Power Park Modules in operation before 1 January 2006	3
BC3.5.4 Frequency Sensitive Mode.....	3
BC3.5.5 System Frequency Induced Change	4
BC3.6 RESPONSE TO LOW FREQUENCY	4
BC3.6.1 Low Frequency Relay Initiated Response from Gensets.....	4
BC3.6.2 Low Frequency Relay Initiated Response from Demand.....	5
BC3.7 RESPONSE TO HIGH FREQUENCY REQUIRED FROM SYNCHRONISED. GENSETS (AND DC CONVERTERS AT DC CONVERTER STATIONS WHEN TRANSFERRING ACTIVE POWER TO THE TOTAL SYSTEM)	5
BC3.7.1 Plant in Frequency Sensitive Mode instructed to provide High Frequency Response.....	5
BC3.7.2 Plant in Limited Frequency Sensitive Mode.....	6
BC3.7.3 Plant Operation to below Minimum Generation	7
BC3.7.5 Information update to NGET	8

BC3.7.6 Existing Gas Cooled Reactor Plant and Power Park Modules in operation
before 1 January 2006 8

BC3.7.7 Externally Interconnected System Operators 8

FREQUENCY CONTROL PROCESS

BC3.1 INTRODUCTION

BC3.1.1 **BC3** sets out the procedure for **NGET** to use in relation to **Users** to undertake **System Frequency** control. **System Frequency** will be controlled by response from **Gensets** (and **DC Converters** at **DC Converter Stations**) operating in **Limited Frequency Sensitive Mode** or **Frequency Sensitive Mode**, by the issuing of instructions to **Gensets** (and **DC Converters** at **DC Converter Stations**) and by control of **Demand**. The requirements for **Frequency** control are determined by the consequences and effectiveness of the **Balancing Mechanism**, and accordingly, **BC3** is complementary to **BC1** and **BC2**.

BC3.1.2 Inter-relationship with Ancillary Services

The provision of response (other than by operation in **Limited Frequency Sensitive Mode** or in accordance with BC3.7.1(c)) in order to contribute towards **Frequency** control, as described in **BC3**, by **Generators** or **DC Converter Station** owners will be an **Ancillary Service**. **Ancillary Services** are divided into three categories, **System Ancillary Services** Parts 1 and 2 and **Commercial Ancillary Services**. **System Ancillary Services**, Parts 1 and 2, are those **Ancillary Services** listed in CC.8.1; those in Part 1 of CC.8.1 are those for which the **Connection Conditions** require the capability as a condition of connection and those in Part 2 are those which may be agreed to be provided by **Users** and which can only be utilised by **NGET** if so agreed. **Commercial Ancillary Services** like those **System Ancillary Services** set out in Part 2 of CC.8.1, may be agreed to be provided by **Users** and which can only be utilised by **NGET** if so agreed.

BC3.1.3 The provision of **Frequency** control services, if any, from an **External System** via a **DC Converter Station** will be provided for in the **Ancillary Services Agreement** and/or **Bilateral Agreement** with the **DC Converter Station** owner and/or any other relevant agreements with the relevant **EISO**.

BC3.2 OBJECTIVE

The procedure for **NGET** to direct **System Frequency** control is intended to enable (as far as possible) **NGET** to meet the statutory requirements of **System Frequency** control.

BC3.3 SCOPE

BC3 applies to **NGET** and to **Users**, which in this BC3 means:-

- (a) **Generators** with regard to their **Large Power Stations** (except those **Large Power Stations** comprising of **Power Park Modules** in **SHETL's** **Transmission Area** with a **Registered Capacity** less than 30MW),
- (b) **Network Operators**,
- (c) **DC Converter Station** owners,

- (d) other providers of **Ancillary Services**, and
- (e) **Externally Interconnected System Operators**.

BC3.4 MANAGING SYSTEM FREQUENCY

BC3.4.1 Statutory Requirements

When **NGET** determines it is necessary (by having monitored the **System Frequency**), it will, as part of the procedure set out in **BC2**, issue instructions (including instructions for **Commercial Ancillary Services**) in order to seek to regulate **System Frequency** to meet the statutory requirements of **Frequency** control. **Gensets** (except those comprising of a **Power Park Module** in **SHETL's Transmission Area** in a **Power Station** with a **Registered Capacity** less than 30MW and those comprising of a **Power Park Module** in Scotland with a **Completion Date** before 1 July 2004) and **DC Converters** at **DC Converter Stations** when transferring **Active Power** to the **Total System**, operating in **Frequency Sensitive Mode** will be instructed by **NGET** to operate taking due account of the **Target Frequency** notified by **NGET**.

BC3.4.2 Target Frequency

NGET will give 15 minutes notice of variation in **Target Frequency**.

BC3.4.3 Electric Time

NGET will endeavour (in so far as it is able) to control electric clock time to within plus or minus 10 seconds by specifying changes to **Target Frequency**, by accepting bids and offers in the **Balancing Mechanism**. Errors greater than plus or minus 10 seconds may be temporarily accepted at **NGET's** reasonable discretion.

BC3.5 RESPONSE FROM GENSETS (AND DC CONVERTERS AT DC CONVERTER STATIONS) WHEN TRANSFERRING ACTIVE POWER TO THE TOTAL SYSTEM)

BC3.5.1 Capability

Each **Genset** (except those comprising of **Power Park Modules** in **SHETL's Transmission Area** in a **Power Station** with a **Registered Capacity** less than 30MW and those comprising of **Power Park Modules** in Scotland with a **Completion Date** before 1 July 2004) and each **DC Converter** at a **DC Converter Station** must at all times have the capability to operate automatically so as to provide response to changes in **Frequency** in accordance with the requirements of CC.6.3.7 in order to contribute to containing and correcting the **System Frequency** within the statutory requirements of **Frequency** control. . For **DC Converters** at **DC Converter Stations**, BC.3.1.3 also applies. In addition each **Genset** (and each **DC Converter** at a **DC Converter Station**) must at all times have the capability to operate in a **Limited Frequency Sensitive Mode** by operating so as to provide **Limited High Frequency Response**.

BC3.5.2 Limited Frequency Sensitive Mode

Each **Synchronised Genset** producing **Active Power** (and each **DC Converter** at a **DC Converter Station**) must operate at all times in a **Limited Frequency Sensitive Mode** (unless instructed in accordance with BC3.5.4 below to operate in **Frequency Sensitive Mode**). Operation in **Limited Frequency Sensitive Mode** must achieve the capability requirement described in CC.6.3.3 for **System**

Frequencies up to 50.4Hz and shall be deemed not to be in contravention of CC.6.3.7.

BC3.5.3

- (a) **Existing Gas Cooled Reactor Plant**
NGET will permit **Existing Gas Cooled Reactor Plant** other than **Frequency Sensitive AGR Units** to operate in **Limited Frequency Sensitive Mode** at all times.
- (b) **Power Park Modules** in operation before 1 January 2006
NGET will permit **Power Park Modules** in operation before 1 January 2006 to operate in **Limited Frequency Sensitive Mode** at all times. For the avoidance of doubt **Power Park Modules** in England and Wales with a **Completion Date** on or after 1 January 2006 and **Power Park Modules** in operation in Scotland after 1 January 2006 with a completion date after 1 July 2004 and in a **Power Station** with a **Registered Capacity** of 30MW and greater will be required to operate in both **Limited Frequency Sensitive Mode** and **Frequency Sensitive Mode** of operation depending on **System** conditions.

BC3.5.4

Frequency Sensitive Mode

- (a) NGET may issue an instruction to a **Genset** (or **DC Converter** at a **DC Converter Station** if agreed as described in BC.3.1.3) to operate so as to provide **Primary Response** and/or **Secondary Response** and/or **High Frequency Response** (in the combinations agreed in the relevant **Ancillary Services Agreement**). When so instructed, the **Genset** or **DC Converter** at a **DC Converter Station** must operate in accordance with the instruction and will no longer be operating in **Limited Frequency Sensitive Mode**, but by being so instructed will be operating in **Frequency Sensitive Mode**.
- (b) **Frequency Sensitive Mode** is the generic description for a **Genset** (or **DC Converter** at a **DC Converter Station**) operating in accordance with an instruction to operate so as to provide **Primary Response** and/or **Secondary Response** and/or **High Frequency Response** (in the combinations agreed in the relevant **Ancillary Services Agreement**).
- (c) The magnitude of the response in each of those categories instructed will be in accordance with the relevant **Ancillary Services Agreement** with the **Generator** or **DC Converter Station** owner.
- (d) Such instruction will continue until countermanded by NGET or until;
- (i) the **Genset** is **De-Synchronised**; or
 - (ii) the **DC Converter** ceases to transfer **Active Power** to or from the **Total System** subject to the conditions of any relevant agreement relating to the operation of the **DC Converter Station**,
- whichever is the first to occur.
- (e) NGET will not so instruct **Generators** in respect of **Existing Gas Cooled Reactor Plant** other than **Frequency Sensitive AGR Units**.
- (f) NGET will not so instruct **Generators** in respect of **Power Park Modules**:

- (i) in Scotland in a **Power Station** with a **Completion Date** before 1 July 2004; or,
- (ii) in **SHETL's Transmission Area** in a **Power Station** with a **Registered Capacity** of less than 30MW.
- (iii) in England and Wales with a **Completion Date** before 1 January 2006.

BC3.5.5 **System Frequency Induced Change**

A **System Frequency** induced change in the **Active Power** output of a **Genset** (or **DC Converter** at a **DC Converter Station**)_which assists recovery to **Target Frequency** must not be countermanded by a **Generator** or **DC Converter Station** owner_ except where it is done purely on safety grounds (relating to either personnel or plant) or, where necessary, to ensure the integrity of the **Power Station** or **DC Converter Station**.

BC3.6 **RESPONSE TO LOW FREQUENCY**

BC3.6.1 **Low Frequency Relay** Initiated Response from **Gensets** and **DC Converters** at **DC Converter Stations**

(a) **NGET** may utilise **Gensets** (and **DC Converters** at **DC Converter Stations**) with the capability of **Low Frequency Relay** initiated response as:

- (i) synchronisation and generation from standstill;
- (ii) generation from zero generated output;
- (iv) increase in generated output;
- (iv) increase in **DC Converter** output to the **Total System** (if so agreed as described in BC3.1.3);
- (v) decrease in **DC Converter** input from the **Total System** (if so agreed as described in BC3.1.3);

in establishing its requirements for **Operating Reserve**.

- (b) (i) **NGET** will specify within the range agreed with **Generators** and/or **EISOs** and/or **DC Converter Station** owners (if so agreed as described in BC3.1.3), **Low Frequency Relay** settings to be applied to **Gensets** or **DC Converters** at **DC Converter Stations** pursuant to BC3.6.1 (a) and instruct the **Low Frequency Relay** initiated response placed in and out of service.
- (ii) **Generators** and/or **EISOs** and/or **DC Converter Station** owners (if so agreed as described in BC3.1.3)_will comply with **NGET** instructions for **Low Frequency Relay** settings and **Low Frequency Relay** initiated response to be placed in or out of service. **Generators** or **DC Converter Station** owners or **EISOs** may not alter such **Low Frequency Relay** settings or take **Low Frequency Relay** initiated response out of service without **NGET's**

agreement (such agreement not to be unreasonably withheld or delayed), except for safety reasons.

BC3.6.2 Low Frequency Relay Initiated Response from Demand and other Demand modification arrangements (which may include a DC Converter Station when importing Active Power from the Total System)

- (a) **NGET** may, pursuant to an **Ancillary Services Agreement**, utilise **Demand** with the capability of **Low Frequency Relay** initiated **Demand** reduction in establishing its requirements for **Frequency Control**.
- (b)
 - (i) **NGET** will specify within the range agreed the **Low Frequency Relay** settings to be applied pursuant to BC3.6.2 (a), the amount of **Demand** reduction to be available and will instruct the **Low Frequency Relay** initiated response to be placed in or out of service.
 - (ii) **Users** will comply with **NGET** instructions for **Low Frequency Relay** settings and **Low Frequency Relay** initiated **Demand** reduction to be placed in or out of service. **Users** may not alter such **Low Frequency Relay** settings or take **Low Frequency Relay** initiated response out of service without **NGET's** agreement, except for safety reasons.
 - (iii) In the case of any such **Demand** which is **Embedded**, **NGET** will notify the relevant **Network Operator** of the location of the **Demand**, the amount of **Demand** reduction to be available, and the **Low Frequency Relay** settings.
- (c) **NGET** may also utilise other **Demand** modification arrangements pursuant to an agreement for **Ancillary Services**, in order to contribute towards **Operating Reserve**.

BC3.7 RESPONSE TO HIGH FREQUENCY REQUIRED FROM SYNCHRONISED GENSETS (AND DC CONVERTERS AT DC CONVERTER STATIONS WHEN TRANSFERRING ACTIVE POWER TO THE TOTAL SYSTEM)

BC3.7.1 Plant in Frequency Sensitive Mode instructed to provide High Frequency Response

- (a) Each **Synchronised Genset** (or each **DC Converter** at a **DC Converter Station**) in respect of which the **Generator** or **DC Converter Station** owner and/or **EISO** has been instructed to operate so as to provide **High Frequency Response**, which is producing **Active Power** and which is operating above the **Designed Minimum Operating Level**, is required to reduce **Active Power** output in response to an increase in **System Frequency** above the **Target Frequency** (or such other level of **Frequency** as may have been agreed in an **Ancillary Services Agreement**). The **Target Frequency** is normally 50.00 Hz except where modified as specified under BC3.4.2.
- (b)
 - (i) The rate of change of **Active Power** output with respect to **Frequency** up to 50.5 Hz shall be in accordance with the provisions of the relevant **Ancillary Services Agreement** with each **Generator** or **DC Converter Station** owner. If more than one rate is provided for

in the **Ancillary Services Agreement** NGET will instruct the rate when the instruction to operate to provide **High Frequency Response** is given.

- (ii) The reduction in **Active Power** output by the amount provided for in the relevant **Ancillary Services Agreement** must be fully achieved within 10 seconds of the time of the **Frequency** increase and must be sustained at no lesser reduction thereafter.
 - (iii) It is accepted that the reduction in **Active Power** output may not be to below the **Designed Minimum Operating Level**.
- (c) In addition to the **High Frequency Response** provided, the **Genset** (or **DC Converter** at a **DC Converter Station**) must continue to reduce **Active Power** output in response to an increase in **System Frequency** to 50.5 Hz or above at a minimum rate of 2 per cent of output per 0.1 Hz deviation of **System Frequency** above that level, such reduction to be achieved within five minutes of the rise to or above 50.5 Hz. For the avoidance of doubt, the provision of this reduction in **Active Power** output is not an **Ancillary Service**.

BC3.7.2 Plant in Limited Frequency Sensitive Mode

- (a) Each **Synchronised Genset** (or **DC Converter** at a **DC Converter Station**) operating in a **Limited Frequency Sensitive Mode** which is producing **Active Power** is also required to reduce **Active Power** output in response to **System Frequency** when this rises above 50.4 Hz. In the case of **DC Converters** at **DC Converter Stations**, the provisions of **BC.3.7.7** are also applicable. For the avoidance of doubt, the provision of this reduction in **Active Power** output is not an **Ancillary Service**. Such provision is known as "**Limited High Frequency Response**".
- (b) (i) The rate of change of **Active Power** output must be at a minimum rate of 2 per cent of output per 0.1 Hz deviation of **System Frequency** above 50.4 Hz.
 - (ii) The reduction in **Active Power** output must be continuously and linearly proportional, as far as is practicable, to the excess of **Frequency** above 50.4 Hz and must be provided increasingly with time over the period specified in (iii) below.
 - (iii) As much as possible of the proportional reduction in **Active Power** output must result from the frequency control device (or speed governor) action and must be achieved within 10 seconds of the time of the **Frequency** increase above 50.4 Hz.
 - (iv) The residue of the proportional reduction in **Active Power** output which results from automatic action of the **Genset** (or **DC Converter** at a **DC Converter Station**) output control devices other than the **frequency control devices** (or speed governors) must be achieved within 3 minutes from the time of the **Frequency** increase above 50.4 Hz.
 - (v) Any further residue of the proportional reduction which results from non-automatic action initiated by the **Generator** or **DC Converter**

Station owner shall be initiated within 2 minutes, and achieved within 5 minutes, of the time of the **Frequency** increase above 50.4 Hz.

- (c) Each **Genset** (or **DC Converter** at a **DC Converter Station**) which is providing **Limited High Frequency Response** in accordance with this BC3.7.2 must continue to provide it until the **Frequency** has returned to or below 50.4 Hz or until otherwise instructed by **NGET**.

BC3.7.3 Plant operation to below **Minimum Generation**

- (a) As stated in CC.A.3.2, steady state operation below **Minimum Generation** is not expected but if **System** operating conditions cause operation below **Minimum Generation** which give rise to operational difficulties for the **Genset** (or **DC Converter** at a **DC Converter Station**) then **NGET** should not, upon request, unreasonably withhold issuing a **Bid-Offer Acceptance** to return the **Generating Unit** or **CCGT Module** or **Power Park Module** or **DC Converter** to an output not less than **Minimum Generation**. In the case of a **DC Converter** not participating in the **Balancing Mechanism**, then **NGET** will, upon request, attempt to return the **DC Converter** to an output not less than **Minimum Generation** or to zero transfer or to reverse the transfer of **Active Power**.
- (b) It is possible that a **Synchronised Genset** (or a **DC Converter** at a **DC Converter Station**) which responded as required under BC3.7.1 or BC3.7.2 to an excess of **System Frequency**, as therein described, will (if the output reduction is large or if the **Genset** (or a **DC Converter** at a **DC Converter Station**) output has reduced to below the **Designed Minimum Operating Level**) trip after a time.
- (c) All reasonable efforts should in the event be made by the **Generator** or **DC Converter Station** owner to avoid such tripping, provided that the **System Frequency** is below 52Hz.
- (d) If the **System Frequency** is at or above 52Hz, the requirement to make all reasonable efforts to avoid tripping does not apply and the **Generator** or **DC Converter Station** owner is required to take action to protect the **Generating Units**, **Power Park Modules** or **DC Converters** as specified in CC.6.3.13.
- (e) In the event of the **System Frequency** becoming stable above 50.5Hz, after all **Genset** and **DC Converter** action as specified in BC3.7.1 and BC3.7.2 has taken place, **NGET** will issue appropriate **Bid-Offer Acceptances** and/or **Ancillary Service** instructions, which may include **Emergency Instructions** under **BC2** to trip **Gensets** (or, in the case of **DC Converters** at **DC Converter Stations**, to stop or reverse the transfer of **Active Power**) so that the **Frequency** returns to below 50.5Hz and ultimately to **Target Frequency**.
- (f) If the **System Frequency** has become stable above 52 Hz, after all **Genset** and **DC Converter** action as specified in BC3.7.1 and BC3.7.2 has taken place, **NGET** will issue **Emergency Instructions** under **BC2** to trip appropriate **Gensets** (or in the case of **DC Converters** at **DC Converter Stations** to stop or reverse the transfer of **Active Power**) to bring the **System Frequency** to below 52Hz and follow this with appropriate **Bid-Offer Acceptances** or **Ancillary Service** instructions or further

Emergency Instructions under **BC2** to return the **System Frequency** to below 50.5 Hz and ultimately to **Target Frequency**.

BC3.7.4 The **Generator** or **DC Converter Station** owner will not be in breach of any of the provisions of BC2 by following the provisions of BC3.7.1, BC3.7.2 or BC3.7.3.

BC3.7.5 Information update to **NGET**

In order that **NGET** can deal with the emergency conditions effectively, it needs as much up to date information as possible and accordingly **NGET** must be informed of the action taken in accordance with BC3.7.1(c) and BC3.7.2 as soon as possible and in any event within 7 minutes of the rise in **System Frequency**, directly by telephone from the **Control Point** for the **Power Station** or **DC Converter Station**.

BC3.7.6 (a) **Existing Gas Cooled Reactor Plant**

For the avoidance of doubt, **Generating Units** within **Existing Gas Cooled Reactor Plant** are required to comply with the applicable provisions of this BC3.7 (which, for the avoidance of doubt, other than for **Frequency Sensitive AGR Units**, do not include BC3.7.1).

(b) **Power Park Modules** in operation before 1 January 2006.

For the avoidance of doubt, **Power Park Modules** in operation (irrespective of their **Completion Dates**) before 1 January 2006 are required to comply with the applicable provisions of this BC3.7 (which, for the avoidance of doubt do not include BC3.7.1).

BC3.7.7 **Externally Interconnected System Operators**

NGET will use reasonable endeavours to ensure that, if **System Frequency** rises above 50.4Hz, and an **Externally Interconnected System Operator** (in its role as operator of the **External System**) is transferring power into the **GB Transmission System** from its **External System**, the amount of power transferred in to the **GB Transmission System** from the **System** of that **Externally Interconnected System Operator** is reduced at a rate equivalent to (or greater than) that which applies for **Synchronised Gensets** operating in **Limited Frequency Sensitive Mode** which are producing **Active Power**. This will be done either by utilising existing arrangements which are designed to achieve this, or by issuing **Emergency Instructions** under **BC2**.

< End of BC3 >

DATA REGISTRATION CODE

CONTENTS

(This contents page does not form part of the Grid Code)

<u>Paragraph No/Title</u>	<u>Page Number</u>
DRC.1 INTRODUCTION	1
DRC.2 OBJECTIVE.....	1
DRC.3 SCOPE.....	1
DRC.4 DATA CATEGORIES AND STAGES IN REGISTRATION.....	2
DRC.4.2 Standard Planning Data	2
DRC.4.3 Detailed Planning Data.....	2
DRC.4.4 Operational Data	2
DRC.5 PROCEDURES AND RESPONSIBILITIES	2
DRC.5.1 Responsibility for Submission and Updating of Data	2
DRC.5.2 Methods of Submitting Data	3
DRC.5.3 Changes to Users Data	3
DRC.5.4 Data not Supplied.....	3
DRC.6 DATA TO BE REGISTERED	4
SCHEDULE 1 - GENERATING UNIT TECHNICAL DATA	7
SCHEDULE 2 - GENERATION PLANNING PARAMETERS.....	22
SCHEDULE 3 - LARGE POWER STATION OUTAGE PROGRAMMES, OUTPUT USABLE AND INFLEXIBILITY INFORMATION.....	25
SCHEDULE 4 – GOVERNOR DROOP AND RESPONSE	28
SCHEDULE 5 - USERS SYSTEM DATA	29
SCHEDULE 6 - USERS OUTAGE INFORMATION.....	38
SCHEDULE 7 - LOAD CHARACTERISTICS AT GRID SUPPLY POINTS	39
SCHEDULE 8 - DATA SUPPLIED BY BM PARTICIPANTS	40
SCHEDULE 9 - DATA SUPPLIED BY NGET TO USERS	41
SCHEDULE 10 - DEMAND PROFILES AND ACTIVE ENERGY DATA	42
SCHEDULE 11 - CONNECTION POINT DATA	44
SCHEDULE 12 - DEMAND CONTROL	48

SCHEDULE 13 - FAULT INFEEED DATA.....	50
SCHEDULE 14 - FAULT INFEEED DATA (GENERATORS).....	51
SCHEDULE 15 – MOTHBALLED GENERATING UNIT INFORMATION	53

DATA REGISTRATION CODE

DRC.1 INTRODUCTION

DRC.1.1 The **Data Registration Code** ("**DRC**") presents a unified listing of all data required by **NGET** from **Users** and by **Users** from **NGET**, from time to time under the **Grid Code**. The data which is specified in each section of the **Grid Code** is collated here in the **DRC**. Where there is any inconsistency in the data requirements under any particular section of the **Grid Code** and the **Data Registration Code** the provisions of the particular section of the **Grid Code** shall prevail.

DRC.1.2 The **DRC** identifies the section of the **Grid Code** under which each item of data is required.

DRC.1.3 The Code under which any item of data is required specifies procedures and timings for the supply of that data, for routine updating and for recording temporary or permanent changes to that data. All timetables for the provision of data are repeated in the **DRC**.

DRC.1.4 Various sections of the **Grid Code** also specify information which the **Users** will receive from **NGET**. This information is summarised in a single schedule in the **DRC** (Schedule 9).

DRC.2 OBJECTIVE

The objective of the **DRC** is to:

DRC.2.1 List and collate all the data to be provided by each category of **User** to **NGET** under the **Grid Code**.

DRC.2.2 List all the data to be provided by **NGET** to each category of **User** under the **Grid Code**.

DRC.3 SCOPE

DRC.3.1 The **DRC** applies to **NGET** and to **Users**, which in this **DRC** means:-

- (a) **Generators;**
- (b) **Network Operators;**
- (c) **DC Converter Station owners**
- (d) **Suppliers;**
- (e) **Non-Embedded Customers** (including, for the avoidance of doubt, a **Pumped Storage Generator** in that capacity);
- (f) **Externally Interconnected System Operators;**

(g) **Interconnector Users;** and

(h) **BM Participants.**

DRC.4 DATA CATEGORIES AND STAGES IN REGISTRATION

DRC.4.1.1 Within the **DRC** each data item is allocated to one of the following three categories:

(a) **Standard Planning Data (SPD)**

(b) **Detailed Planning Data (DPD)**

(c) **Operational Data**

DRC.4.2 Standard Planning Data (SPD)

DRC.4.2.1 The **Standard Planning Data** listed and collated in this **DRC** is that data listed in Part 1 of the Appendix to the PC.

DRC.4.2.2 **Standard Planning Data** will be provided to **NGET** in accordance with PC.4.4 and PC.A.1.2.

DRC.4.3 Detailed Planning Data (DPD)

DRC.4.3.1 The **Detailed Planning Data** listed and collated in this **DRC** is that data listed in Part 2 of the Appendix to the PC.

DRC.4.3.2 **Detailed Planning Data** will be provided to **NGET** in accordance with PC.4.4, PC.4.5 and PC.A.1.2.

DRC.4.4 Operational Data

DRC.4.4.1 **Operational Data** is data which is required by the **Operating Codes** and the **Balancing Codes**. Within the **DRC**, **Operational Data** is sub-categorised according to the **Code** under which it is required, namely **OC1**, **OC2**, **BC1** or **BC2**.

DRC.4.4.2 **Operational Data** is to be supplied in accordance with timetables set down in the relevant **Operating Codes** and **Balancing Codes** and repeated in tabular form in the schedules to the **DRC**.

DRC.5 PROCEDURES AND RESPONSIBILITIES

DRC.5.1 Responsibility for Submission and Updating of Data

In accordance with the provisions of the various sections of the **Grid Code**, each **User** must submit data as summarised in DRC.6 and listed and collated in the attached schedules.

DRC.5.2 Methods of Submitting Data

DRC.5.2.1 Wherever possible the data schedules to the **DRC** are structured to serve as standard formats for data submission and such format must be used for the written submission of data to **NGET**.

DRC.5.2.2 Data must be submitted to the **Transmission Control Centre** notified by **NGET** or to such other department or address as **NGET** may from time to time advise. The name of the person at the **User** who is submitting each schedule of data must be included.

DRC.5.2.3 Where a computer data link exists between a **User** and **NGET**, data may be submitted via this link. **NGET** will, in this situation, provide computer files for completion by the **User** containing all the data in the corresponding **DRC** schedule.

Data submitted under Schedule 5, with the exception of the single line diagram, shall be submitted on floppy disk using a proforma to be supplied by **NGET**, or by any other means or format as may be agreed between the **User** and **NGET**. This proforma is to be supplied by **NGET** no later than calendar week 19 in each year.

DRC.5.2.4 Other modes of data transfer, such as magnetic tape, may be utilised if **NGET** gives its prior written consent.

DRC.5.3 Changes to Users' Data

DRC.5.3.1 Whenever a **User** becomes aware of a change to an item of data which is registered with **NGET** the **User** must notify **NGET** in accordance with each section of the **Grid Code**. The method and timing of the notification to **NGET** is set out in each section of the **Grid Code**.

DRC.5.4 Data not Supplied

DRC.5.4.1 **Users** and **NGET** are obliged to supply data as set out in the individual sections of the **Grid Code** and repeated in the **DRC**. If a **User** fails to supply data when required by any section of the **Grid Code**, **NGET** will estimate such data if and when, in the **NGET's** view, it is necessary to do so. If **NGET** fails to supply data when required by any section of the **Grid Code**, the **User** to whom that data ought to have been supplied, will estimate such data if and when, in that **User's** view, it is necessary to do so. Such estimates will, in each case, be based upon data supplied previously for the same **Plant** or **Apparatus** or upon corresponding data for similar **Plant** or **Apparatus** or upon such other information as **NGET** or that **User**, as the case may be, deems appropriate.

DRC.5.4.2 **NGET** will advise a **User** in writing of any estimated data it intends to use pursuant to DRC.5.4.1 relating directly to that **User's Plant** or **Apparatus** in the event of data not being supplied.

DRC.5.4.3 A **User** will advise **NGET** in writing of any estimated data it intends to use pursuant to DRC.5.4.1 in the event of data not being supplied.

- DRC.6 **DATA TO BE REGISTERED**
- DRC.6.1 Schedules 1 to 15 attached cover the following data areas.
- DRC.6.1.1 SCHEDULE 1 - **GENERATING UNIT (OR CCGT Module), POWER PARK MODULE and DC CONVERTER TECHNICAL DATA.**
- Comprising **Generating Unit (and CCGT Module), Power Park Module and DC Converter** fixed electrical parameters.
- DRC.6.1.2 SCHEDULE 2 - **GENERATION PLANNING PARAMETERS**
- DRC.6.1.3 SCHEDULE 3 - **LARGE POWER STATION OUTAGE PROGRAMMES, OUTPUT USABLE AND INFLEXIBILITY INFORMATION.**
- Comprising generation outage planning, **Output Usable** and inflexibility information at timescales down to the daily **BM Unit Data** submission.
- DRC.6.1.4 SCHEDULE 4 - **LARGE POWER STATION DROOP AND RESPONSE DATA.**
- Comprising data on governor **Droop** settings and **Primary, Secondary and High Frequency Response** data for **Large Power Stations.**
- DRC.6.1.5 SCHEDULE 5 - **USER'S SYSTEM DATA.**
- Comprising electrical parameters relating to **Plant** and **Apparatus** connected to the **GB Transmission System.**
- DRC.6.1.6 SCHEDULE 6 - **USERS OUTAGE INFORMATION.**
- Comprising the information required by **NGET** for outages on the **Users System,** including outages at **Power Stations** other than outages of **Gensets**
- DRC.6.1.7 SCHEDULE 7 - **LOAD CHARACTERISTICS.**
- Comprising the estimated parameters of load groups in respect of, for example, harmonic content and response to frequency.
- DRC.6.1.8 SCHEDULE 8 - **BM UNIT DATA.**
- DRC.6.1.9 SCHEDULE 9 - **DATA SUPPLIED BY NGET TO USERS.**
- DRC.6.1.10 SCHEDULE 10 - **DEMAND PROFILES AND ACTIVE ENERGY DATA**
- Comprising information relating to the **Network Operators' and Non-Embedded Customers'** total **Demand** and **Active Energy** taken from the **GB Transmission System**
- DRC.6.1.11 SCHEDULE 11 - **CONNECTION POINT DATA**
- Comprising information relating to **Demand,** demand transfer capability and a summary of the **Small Power Station, Medium Power Station** and **Customer** generation connected to the **Connection Point**

- DRC.6.1.12 **SCHEDULE 12 - DEMAND CONTROL DATA**
 Comprising information related to **Demand Control**
- DRC.6.1.13 **SCHEDULE 13 - FAULT INFEEED DATA**
 Comprising information relating to the Short Circuit contribution to the **GB Transmission System** from **Users** other than **Generators** and **DC Converter Station** owners.
- DRC.6.1.14 **SCHEDULE 14 - FAULT INFEEED DATA**
 Comprising information relating to the Short Circuit contribution to the **GB Transmission System** from **Generators** and **DC Converter Station** owners.
- DRC.6.1.15 **SCHEDULE 15 – MOTHBALLED GENERATING UNIT, MOTHBALLED POWER PARK MODULE, MOTHBALLED DC CONVERTERS AT A DC CONVERTER STATION AND ALTERNATIVE FUEL DATA**
 Comprising information relating to estimated return to service times for **Mothballed Generating Units, Mothballed Power Park Modules** and **Mothballed DC Converters at a DC Converter Station** and the capability of gas-fired **Generating Units** to operate using alternative fuels.
- DRC.6.2 The **Schedules** applicable to each class of **User** are as follows:
- | | |
|---|-----------------------------|
| Generators with Large Power Stations | Sched 1, 2, 3, 4, 9, 14, 15 |
| Generators with Medium Power Stations (See note 2) | Sched 1, 9, 14, 15 |
| Generators with Small Power Stations directly connected to the GB Transmission System | Sched 1, 6, 14, 15 |
| All Users connected directly to GB Transmission System | Sched 5, 6, 9 |
| All Users connected directly to the GB Transmission System other than Generators | Sched 10,11,13 |
| All Users connected directly to GB Transmission System with Demand | Sched 7, 9 |
| A Pumped Storage Generator, Externally Interconnected System Operator and Interconnector Users | Sched12
(as marked) |
| All Suppliers | Sched 12 |
| All Network Operators | Sched 12 |

All **BM Participants**

Sched 8

All **DC Converter Station** owners

Sched 1, 4, 9, 14, 15

Notes:

1. **Network Operators** must provide data relating to **Small Power Stations** and/or **Customer Generating Plant Embedded** in their **Systems** when such data is requested by **NGET** pursuant to PC.A.3.1.4 or PC.A.5.1.4.
2. The data in schedules 1, 14 and 15 need not be supplied in relation to **Medium Power Stations** connected at a voltage level below the voltage level of the **Subtransmission System** except in connection with a **CUSC Contract** or unless specifically requested by **NGET**.

GENERATING UNIT (OR CCGT MODULE) TECHNICAL DATA

POWER STATION NAME: _____

DATE: _____

DATA DESCRIPTION	UNITS	DATA CAT.	GENERATING UNIT OR STATION DATA						
			FYr 0	FYr 1	FYr 2	FYr 3	FYr 4	FYr 5	FYr 6
<u>GENERATING STATION DEMANDS:</u>									
<p>Demand associated with the Power Station supplied through the GB Transmission System or the Generator's User System</p> <ul style="list-style-type: none"> - The maximum Demand that could occur. - Demand at specified time of annual peak half hour of GB Transmission System Demand at Annual ACS Conditions. - Demand at specified time of annual minimum half-hour of GB Transmission System Demand. <p>(Additional Demand supplied through the unit transformers to be provided below)</p>	<p>MW Mvar</p> <p>MW Mvar</p> <p>MW Mvar</p>	<p>DPD DPD DPD DPD</p> <p>DPD DPD</p>							
<u>INDIVIDUAL GENERATING UNIT (OR AS THE CASE MAY BE, CCGT MODULE) DATA</u>			G1	G2	G3	G4	G5	G6	STN
Point of connection to the GB Transmission System (or the Total System if embedded) of the Generating Unit (other than a CCGT Unit) or the CCGT Module , as the case may be in terms of geographical and electrical location and system voltage	Text	SPD							
If the busbars at the Connection Point are normally run in separate sections identify the section to which the Generating Unit (other than a CCGT Unit) or CCGT Module , as the case may be is connected	Section Number	SPD							
Type of Unit (steam, Gas Turbine Combined Cycle Gas Turbine Unit , tidal, wind, etc.)									
A list of the CCGT Units within a CCGT Module , identifying each CCGT Unit , and the CCGT Module of which it forms part, unambiguously. In the case of a Range CCGT Module , details of the possible configurations should also be submitted.		SPD							

ABBREVIATIONS:

SPD	= Standard Planning Data	DPD	= Detailed Planning Data
% on MVA	= % on Rated MVA	RC	= Registered Capacity
% on 100	= % on 100 MVA	OC1, BC1, etc	= Grid Code for which data is required

Note:

All parameters, where applicable, are to be measured at nominal **System Frequency**

- + - these **SPD** items should only be given in the data supplied with the application for a **CUSC Contract**.
- * - Asterisk items are not required for **Small Power Stations** and **Medium Power Stations**

Information is to be given on a **Unit** basis, unless otherwise stated. Where references to **CCGT Modules** are made, the columns "G1" etc should be amended to read "M1" etc, as appropriate.

DATA DESCRIPTION	UNITS	DATA CAT.	GENERATING UNIT (OR CCGT MODULE, AS THE CASE MAY BE)						
			G1	G2	G3	G4	G5	G6	STN
Rated MVA	MVA	SPD+							
Rated MW	MW	SPD+							
Rated terminal voltage	kV	DPD							
*Performance Chart at Generating Unit stator terminals		SPD	(see OC2 for specification)						
* Output Usable (on a monthly basis)	MW	SPD	(except in relation to CCGT Modules when required on a unit basis under the Grid Code , this data item may be supplied under Schedule 3)						
Turbo-Generator inertia constant (for synchronous machines)	MW secs /MVA	SPD+							
Short circuit ratio (synchronous machines)		SPD+							
Normal auxiliary load supplied by the Generating Unit at rated MW output	MW	DPD							
	Mvar	DPD							
Rated field current at rated MW and Mvar output and at rated terminal voltage	A	DPD							
Field current open circuit saturation curve (as derived from appropriate manufacturers' test certificates):									
	120% rated terminal volts	DPD							
	110% rated terminal volts	DPD							
	100% rated terminal volts	DPD							
	90% rated terminal volts	DPD							
	80% rated terminal volts	DPD							
	70% rated terminal volts	DPD							
	60% rated terminal volts	DPD							
	50% rated terminal volts	DPD							
IMPEDANCES: (Unsaturated)									
Direct axis synchronous reactance	% on MVA	DPD							
Direct axis transient reactance	% on MVA	SPD+							
Direct axis sub-transient reactance	% on MVA	DPD							
Quad axis synch reactance	% on MVA	DPD							
Quad axis sub-transient reactance	% on MVA	DPD							
Stator leakage reactance	% on MVA	DPD							
Armature winding direct current resistance.	% on MVA	DPD							
In Scotland, negative sequence resistance	% on MVA	DPD							
Note:-	the above data item relating to armature winding direct-current resistance need only be provided by Generators in relation to Generating Units commissioned after 1st March 1996 and in cases where, for whatever reason, the Generator is aware of the value of the data item.								

DATA DESCRIPTION	UNITS	DATA CAT.	GENERATING UNIT OR STATION DATA						
			G1	G2	G3	G4	G5	G6	STN
TIME CONSTANTS (Short-circuit and Unsaturated)									
Direct axis transient time constant	S	DPD							
Direct axis sub-transient time constant	S	SPD							
Quadrature axis sub-transient time constant	S	DPD							
Stator time constant	S	DPD							
GENERATING UNIT STEP-UP TRANSFORMER									
Rated MVA	MVA	SPD+							
Voltage Ratio	-	DPD							
Positive sequence reactance:									
Max tap	% on MVA	SPD+							
Min tap	% on MVA	SPD+							
Nominal tap	% on MVA	SPD+							
Positive sequence resistance:									
Max tap	% on MVA	DPD							
Min tap	% on MVA	DPD							
Nominal tap	% on MVA	DPD							
Zero phase sequence reactance	% on MVA	DPD							
Tap change range	+% / -%	DPD							
Tap change step size	%	DPD							
Tap changer type, on-load or off-circuit	On/Off	DPD							
EXCITATION:									
Note: The data items requested under Option 1 below may continue to be provided by Generators in relation to Generating Units on the System at 9 January 1995 (in this paragraph, the "relevant date") or they may provide the new data items set out under Option 2. Generators must supply the data as set out under Option 2 (and not those under Option 1) for Generating Unit excitation control systems commissioned after the relevant date, those Generating Unit excitation control systems recommissioned for any reason such as refurbishment after the relevant date and Generating Unit excitation control systems where, as a result of testing or other process, the Generator is aware of the data items listed under Option 2 in relation to that Generating Unit .									
Option 1									
DC gain of Excitation Loop		DPD							
Max field voltage	V	DPD							
Min field voltage	V	DPD							
Rated field voltage	V	DPD							
Max rate of change of field volts:									
Rising	V/Sec	DPD							
Falling	V/Sec	DPD							
Details of Excitation Loop	Diagram	DPD	(please attach)						
Described in block diagram form showing transfer functions of individual elements									
Dynamic characteristics of over-excitation limiter		DPD							
Dynamic characteristics of under-excitation limiter		DPD							

DATA DESCRIPTION	UNITS	DATA CAT.	GENERATING UNIT OR STATION DATA						
			G1	G2	G3	G4	G5	G6	STN
Option 2									
Exciter category, e.g. Rotating Exciter, or Static Exciter etc	Text	SPD							
Excitation System Nominal Response	V_E	DPD							
Rated Field Voltage	U_{fN}	DPD							
No-load Field Voltage	U_{fO}	DPD							
Excitation System On-Load Positive Ceiling Voltage	U_{pL+}	DPD							
Excitation System No-Load Positive Ceiling Voltage	U_{pO+}	DPD							
Excitation System No-Load Negative Ceiling Voltage	U_{pO-}	DPD							
Power System Stabiliser (PSS) fitted	Yes/No	SPD							
Details of Excitation System (including PSS if fitted) described in block diagram form showing transfer functions of individual elements.	Diagram	DPD							
Details of Over-excitation Limiter described in block diagram form showing transfer functions of individual elements.	Diagram	DPD							
Details of Under-excitation Limiter described in block diagram form showing transfer functions of individual elements.	Diagram	DPD							

DATA DESCRIPTION	UNITS	DATA CAT.	GENERATING UNIT OR STATION DATA						
			G1	G2	G3	G4	G5	G6	STN
<u>GOVERNOR AND ASSOCIATED PRIME MOVER PARAMETERS</u>									
<p>Note: The data items requested under Option 1 below may continue to be provided by Generators in relation to Generating Units on the System at 9 January 1995 (in this paragraph, the "relevant date") or they may provide the new data items set out under Option 2. Generators must supply the data as set out under Option 2 (and not those under Option 1) for Generating Unit governor control systems commissioned after the relevant date, those Generating Unit governor control systems recommissioned for any reason such as refurbishment after the relevant date and Generating Unit governor control systems where, as a result of testing or other process, the Generator is aware of the data items listed under Option 2 in relation to that Generating Unit.</p>									
Option 1									
<u>GOVERNOR PARAMETERS (REHEAT UNITS)</u>									
HP Governor average gain	MW/Hz	DPD							
Speeder motor setting range	Hz	DPD							
HP governor valve time constant	S	DPD							
HP governor valve opening limits		DPD							
HP governor valve rate limits		DPD							
Re-heat time constant (stored Active Energy in reheater)	S	DPD							
IP governor average gain	MW/Hz	DPD							
IP governor setting range	Hz	DPD							
IP governor time constant	S	DPD							
IP governor valve opening limits		DPD							
IP governor valve rate limits		DPD							
Details of acceleration sensitive elements HP & IP in governor loop		DPD	(please attach)						
Governor block diagram showing transfer functions of individual elements		DPD	(please attach)						
<u>GOVERNOR (Non-reheat steam and Gas Turbines)</u>									
Governor average gain	MW/Hz	DPD							
Speeder motor setting range		DPD							
Time constant of steam or fuel governor valve	S	DPD							
Governor valve opening limits		DPD							
Governor valve rate limits		DPD							
Time constant of turbine	S	DPD							
Governor block diagram		DPD	(please attach)						

DATA DESCRIPTION	UNITS	DATA CAT.	GENERATING UNIT OR STATION DATA					
			G1	G2	G3	G4	G5	G6
<u>BOILER & STEAM TURBINE DATA*</u>								
Boiler time constant (Stored Active Energy)	S	DPD						
HP turbine response ratio: (Proportion of Primary Response arising from HP turbine)	%	DPD						
HP turbine response ratio: (Proportion of High Frequency Response arising from HP turbine)	%	DPD						
End of Option 1								
Option 2								
<u>All Generating Units</u>								
Governor Block Diagram showing transfer function of individual elements including acceleration sensitive elements		DPD						
Governor Time Constant	Sec	DPD						
#Governor Deadband								
- Maximum Setting	±Hz	DPD						
- Normal Setting	±Hz	DPD						
- Minimum Setting	±Hz	DPD						
Speeder Motor Setting Range	%	DPD						
Average Gain	MW/Hz	DPD						
<u>Steam Units</u>								
HP Valve Time Constant	sec	DPD						
HP Valve Opening Limits	%	DPD						
HP Valve Opening Rate Limits	%/sec	DPD						
HP Valve Closing Rate Limits	%/sec	DPD						
HP Turbine Time Constant	sec	DPD						
IP Valve Time Constant	sec	DPD						
IP Valve Opening Limits	%	DPD						
IP Valve Opening Rate Limits	%/sec	DPD						
IP Valve Closing Rate Limits	%/sec	DPD						
IP Turbine Time Constant	sec	DPD						
LP Valve Time Constant	sec	DPD						
LP Valve Opening Limits	%	DPD						
LP Valve Opening Rate Limits	%/sec	DPD						
LP Valve Closing Rate Limits	%/sec	DPD						
LP Turbine Time Constant	sec	DPD						
Reheater Time Constant	sec	DPD						
Boiler Time Constant	sec	DPD						
HP Power Fraction	%	DPD						
IP Power Fraction	%	DPD						

Where the generating unit governor does not have a selectable deadband facility, then the actual value of the deadband need only be provided.

DATA DESCRIPTION	UNITS	DATA CAT.	GENERATING UNIT OR STATION DATA					
			G1	G2	G3	G4	G5	G6
<u>Gas Turbine Units</u>								
Inlet Guide Vane Time Constant	sec	DPD						
Inlet Guide Vane Opening Limits	%	DPD						
Inlet Guide Vane Opening Rate Limits	%/sec	DPD						
Inlet Guide Vane Closing Rate Limits	%/sec	DPD						
Fuel Valve Time Constant	sec	DPD						
Fuel Valve Opening Limits	%	DPD						
Fuel Valve Opening Rate Limits	%/sec	DPD						
Fuel Valve Closing Rate Limits	%/sec	DPD						
Waste Heat Recovery Boiler Time Constant								
<u>Hydro Generating Units</u>								
Guide Vane Actuator Time Constant	sec	DPD						
Guide Vane Opening Limits	%	DPD						
Guide Vane Opening Rate Limits	%/sec	DPD						
Guide Vane Closing Rate Limits	%/sec	DPD						
Water Time Constant	sec	DPD						
End of Option 2								
<u>UNIT CONTROL OPTIONS*</u>								
Maximum droop	%	DPD						
Normal droop	%	DPD						
Minimum droop	%	DPD						
Maximum frequency deadband	±Hz	DPD						
Normal frequency deadband	±Hz	DPD						
Minimum frequency deadband	±Hz	DPD						
Maximum Output deadband	±MW	DPD						
Normal Output deadband	±MW	DPD						
Minimum Output deadband	±MW	DPD						
Frequency settings between which Unit Load Controller droop applies:								
Maximum	Hz	DPD						
Normal	Hz	DPD						
Minimum	Hz	DPD						
Sustained response normally selected	Yes/No	DPD						

DATA DESCRIPTION	UNITS	DATA CAT.	POWER PARK UNIT (OR POWER PARK MODULE, AS THE CASE MAY BE)							
			G1	G2	G3	G4	G5	G6	STN	
Power Park Module Rated MVA	MVA	SPD+								
Power Park Module Rated MW	MW	SPD+								
*Performance Chart of a at Power Park Module at the connection point		SPD	(see OC2 for specification)							
* Output Usable (on a monthly basis)	MW	SPD	(except in relation to CCGT Modules when required on a unit basis under the Grid Code , this data item may be supplied under Schedule 3)							
Number & Type of Power Park Units within each Power Park Module										
Power Park Unit Model - A validated mathematical model in accordance with PC.5.4.2 (a)	Transfer function block diagram and algebraic equations, simulation and measured test results	DPD								
Power Park Unit Data (where applicable)										
Rated MVA	MVA	SPD+								
Rated MW	MW	SPD+								
Rated terminal voltage	V	SPD+								
Inertia constant at synchronous speed	MW secs /MVA	SPD+								
Stator Resistance.	% on MVA	DPD								
Stator Reactance.	% on MVA	SPD+								
Magnetising Reactance	% on MVA	SPD+								
Rotor Resistance (at starting).	% on MVA	DPD								
Rotor Resistance (at rated running)	% on MVA	SPD+								
Rotor Reactance (at starting).	% on MVA	DPD								
Rotor Reactance (at rated running)	% on MVA	SPD								
Inertia constant of the wind turbine rotor	MW secs /MVA	DPD								
Inertia constant of the generator rotor	MW secs /MVA	DPD								
Shaft stiffness	Nm / electrical radian	DPD								

DATA DESCRIPTION	UNITS	DATA CAT.	POWER PARK UNIT (OR POWER PARK MODULE, AS THE CASE MAY BE)						
			G1	G2	G3	G4	G5	G6	STN
Minimum generator rotor speed (Doubly Fed Induction Generators)	RPM	SPD+							
Maximum generator rotor speed (Doubly Fed Induction Generators)	RPM	SPD+							
The optimum generator rotor speed versus wind speed	tabular format	DPD							
Power Converter Rating (Doubly Fed Induction Generators)	MVA	SPD+							
The rotor power coefficient (C_p) versus tip speed ratio (λ) curves for a range of blade angles (where applicable)	Diagram + tabular format	DPD							
The electrical power output versus generator rotor speed for a range of wind speeds over the entire operating range of the Power Park Unit .	Diagram + tabular format	DPD							
The blade angle versus wind speed curve	Diagram + tabular format	DPD							
The electrical power output versus wind speed over the entire operating range of the Power Park Unit .	Diagram + tabular format	DPD							
Transfer function block diagram, parameters and description of the operation of the power electronic converter (where applicable).	Diagram	DPD							
For a Power Park Unit consisting of a synchronous machine in combination with a back to back DC Converter , or for a Power Park Unit not driven by a wind turbine, the data to be supplied shall be agreed with NET in accordance with PC.A.7.									

DATA DESCRIPTION	UNITS	DATA CAT.	POWER PARK UNIT (OR POWER PARK MODULE, AS THE CASE MAY BE)						
			G1	G2	G3	G4	G5	G6	STN
<p>Torque / Speed and blade angle control systems and parameters</p> <p>For the Power Park Unit, details of the torque / speed controller and blade angle controller in the case of a wind turbine and power limitation functions (where applicable) described in block diagram form showing transfer functions and parameters of individual elements</p>	Diagram	DPD							
<p>Voltage/Reactive Power/Power Factor control system parameters</p> <p>For the Power Park Unit and Power Park Module details of Voltage/Reactive Power/Power Factor controller (and PSS if fitted) described in block diagram form including parameters showing transfer functions of individual elements.</p>	Diagram	DPD							
<p>Frequency control system parameters</p> <p>For the Power Park Unit and Power Park Module details of the Ffrequency controller described in block diagram form showing transfer functions and parameters of individual elements.</p>	Diagram	DPD							
<p>As an alternative to PC.A.5.4.2 (a), (b), (c), (d), (e) and (f), is the submission of a single complete model that consists of the full information required under PC.A.5.4.2 (a), (b), (c), (d) (e) and (f) provided that all the information required under PC.A.5.4.2 (a), (b), (c), (d), (e) and (f) individually is clearly identifiable.</p>	Diagram	DPD							
<p>Harmonic Assessment Information</p> <p>(as defined in IEC 61400-21 (2001)) for each Power Park Unit:-</p> <p>Flicker coefficient for continuous operation</p> <p>Flicker step factor</p> <p>Number of switching operations in a 10 minute window</p> <p>Number of switching operations in a 2 hour window</p> <p>Voltage change factor</p> <p>Current Injection at each harmonic for each Power Park Unit and for each Power Park Module</p>	Tabular format	DPD DPD DPD DPD DPD DPD							

DC CONVERTER STATION TECHNICAL DATA

DC CONVERTER STATION NAME _____

DATE: _____

Data Description	Units	Data Category	DC Converter Station Data
DC CONVERTER STATION DEMANDS:			
Demand supplied through Station Transformers associated with the DC Converter Station [PC.A.4.1]			
- Demand with all DC Converters operating at Rated MW import.	MW Mvar	DPD DPD	
- Demand with all DC Converters operating at Rated MW export.	MW Mvar	DPD DPD	
Additional Demand associated with the DC Converter Station supplied through the GB Transmission System. [PC.A.4.1]			
- The maximum Demand that could occur.	MW Mvar	DPD DPD	
- Demand at specified time of annual peak half hour of NGET Demand at Annual ACS Conditions.	MW Mvar	DPD DPD	
- Demand at specified time of annual minimum half-hour of NGET Demand.	MW Mvar	DPD DPD	
DC CONVERTER STATION DATA			
Number of poles, i.e. number of DC Converters	Text	SPD+	
Pole arrangement (e.g. monopole or bipole)	Text	SPD+	
Details of each viable operating configuration		SPD+	
Configuration 1	Diagram		
Configuration 2	Diagram		
Configuration 3	Diagram		
Configuration 4	Diagram		
Configuration 5	Diagram		
Configuration 6	Diagram		
Remote ac connection arrangement	Diagram	SPD	

Data Description	Units	Data Category	Operating Configuration					
			1	2	3	4	5	6
DC CONVERTER STATION DATA								
DC Converter Type (e.g. current or Voltage source)	Text	SPD						
Point of connection to the NGET Transmission System (or the Total System if embedded) of the DC Converter Station configuration in terms of geographical and electrical location and system voltage	Text	SPD						
If the busbars at the Connection Point are normally run in separate sections identify the section to which the DC Converter Station configuration is connected	Section Number	SPD						
Rated MW import per pole [PC.A.3.3.1]	MW	SPD+						
Rated MW export per pole [PC.A.3.3.1]	MW	SPD+						
ACTIVE POWER TRANSFER CAPABILITY (PC.A.3.2.2)								
Registered Capacity	MW	SPD						
Registered Import Capacity	MW	SPD						
Minimum Generation	MW	SPD						
Minimum Import Capacity	MW	SPD						
Import MW available in excess of Registered Import Capacity .	MW	SPD						
Time duration for which MW in excess of Registered Import Capacity is available	Min	SPD						
Export MW available in excess of Registered Capacity .	MW	SPD						
Time duration for which MW in excess of Registered Capacity is available	Min	SPD						
DC CONVERTER TRANSFORMER [PC.A.5.4.3.1]								
Rated MVA	MVA	DPD						
Winding arrangement		DPD						
Nominal primary voltage	KV	DPD						
Nominal secondary (converter-side) voltage(s)	KV	DPD						
Positive sequence reactance		DPD						
Maximum tap	% on MVA	DPD						
Nominal tap	% on MVA	DPD						
Minimum tap	% on MVA	DPD						
Positive sequence resistance		DPD						
Maximum tap	% on MVA	DPD						
Nominal tap	% on MVA	DPD						
Minimum tap	% on MVA	DPD						
Zero phase sequence reactance	% on MVA	DPD						
Tap change range	+% / -%	DPD						
Number of steps		DPD						

Data Description	Units	Data Category	Operating configuration					
			1	2	3	4	5	6
<p>DC NETWORK [PC.A.5.4.3.1 (c)]</p> <p>Rated DC voltage per pole Rated DC current per pole</p> <p>Details of the DC Network described in diagram form including resistance, inductance and capacitance of all DC cables and/or DC lines. Details of any line reactors (including line reactor resistance), line capacitors, DC filters, earthing electrodes and other conductors that form part of the DC Network should be shown.</p>	<p>KV A</p> <p>Diagram</p>	<p>DPD DPD DPD</p>						
<p>DC CONVERTER STATION AC HARMONIC FILTER AND REACTIVE COMPENSATION EQUIPMENT [PC.A.5.4.3.1 (d)]</p> <p>For all switched reactive compensation equipment</p> <p>Total number of AC filter banks Diagram of filter connections Type of equipment (e.g. fixed or variable) Capacitive rating; or Inductive rating; or Operating range</p> <p>Reactive Power capability as a function of various MW transfer levels</p>	<p>Diagram</p> <p>Text Diagram Text Mvar Mvar Mvar Table</p>	<p>SPD SPD SPD SPD DPD DPD DPD DPD</p>						

Data Description	Units	Data Category	Operating configuration					
			1	2	3	4	5	6
<p>CONTROL SYSTEMS [PC.A.5.4.3.2]</p> <p>Static $V_{DC} - P_{DC}$ (DC voltage – DC power) or Static $V_{DC} - I_{DC}$ (DC voltage – DC current) characteristic (as appropriate) when operating as –Rectifier –Inverter</p> <p>Diagram Diagram</p> <p>DPD DPD</p> <p>Details of rectifier mode control system, in block diagram form together with parameters showing transfer functions of individual elements.</p> <p>Diagram</p> <p>DPD</p> <p>Details of inverter mode control system, in block diagram form showing transfer functions of individual elements including parameters.</p> <p>Diagram</p> <p>DPD</p> <p>Details of converter transformer tap changer control system in block diagram form showing transfer functions of individual elements including parameters. (Only required for DC converters connected to the GB Transmission System.)</p> <p>Diagram</p> <p>DPD</p> <p>Details of AC filter and reactive compensation equipment control systems in block diagram form showing transfer functions of individual elements including parameters. (Only required for DC converters connected to the GB Transmission System.)</p> <p>Diagram</p> <p>DPD</p> <p>Details of any frequency and/or load control systems in block diagram form showing transfer functions of individual elements including parameters.</p> <p>Diagram</p> <p>DPD</p> <p>Details of any large or small signal modulating controls, such as power oscillation damping controls or sub-synchronous oscillation damping controls, that have not been submitted as part of the above control system data.</p> <p>Diagram</p> <p>DPD</p> <p>Transfer block diagram representation of the reactive power control at converter ends for a voltage source converter.</p> <p>Diagram</p> <p>DPD</p>								
<p>LOADING PARAMETERS [PC.A.5.4.3.3]</p> <p>MW Export Nominal loading rate Maximum (emergency) loading rate</p> <p>MW/s MW/s</p> <p>DPD DPD</p> <p>MW Import Nominal loading rate Maximum (emergency) loading rate</p> <p>MW/s MW/s</p> <p>DPD DPD</p> <p>Maximum recovery time, to 90% of pre-fault loading, following an AC system fault or severe voltage depression.</p> <p>s</p> <p>DPD</p> <p>Maximum recovery time, to 90% of pre-fault loading, following a transient DC Network fault.</p> <p>s</p> <p>DPD</p>								

NOTE:

Users are referred to Schedules 5 & 14 which set down data required for all **Users** directly connected to the **GB Transmission System**, including **Power Stations**.

GENERATION PLANNING PARAMETERS

This schedule contains the **Genset Generation Planning Parameters** required by **NET** to facilitate studies in **Operational Planning** timescales.

For a **Generating Unit** (other than a **Power Park Unit**) at a **Large Power Station** the information is to be submitted on a unit basis and for a **CCGT Module** or **Power Park Module** at a **Large Power Station** the information is to be submitted on a module basis, unless otherwise stated.

Where references to **CCGT Modules** or **Power Park Modules** at a **Large Power Station** are made, the columns "G1" etc should be amended to read "M1" etc, as appropriate.

Power Station: _____

Generation Planning Parameters

DATA DESCRIPTION	UNITS	DATA CAT.	GENSET OR STATION DATA						
			G1	G2	G3	G4	G5	G6	STN
OUTPUT CAPABILITY									
Registered Capacity on a station and unit basis (on a station and module basis in the case of a CCGT Module or Power Park Module at a Large Power Station)	MW	SPD							
Minimum Generation (on a module basis in the case of a CCGT Module or Power Park Module at a Large Power Station)	MW	SPD							
MW available from Generating Units or Power Park Modules in excess of Registered Capacity	MW	SPD							
REGIME UNAVAILABILITY									
These data blocks are provided to allow fixed periods of unavailability to be registered.									
<u>Expected Running Regime.</u> Is Power Station normally available for full output 24 hours per day, 7 days per week? If No please provide details of unavailability below.		SPD							
Earliest Synchronising time:									
Monday	hr/min	OC2							-
Tuesday – Friday	hr/min	OC2							-
Saturday – Sunday	hr/min	OC2							-
Latest De-Synchronising time:									
Monday – Thursday	hr/min	OC2							-
Friday	hr/min	OC2							-
Saturday – Sunday	hr/min	OC2							-
SYNCHRONISING PARAMETERS									
Notice to Deviate from Zero (NDZ) after 48 hour Shutdown	Mins	OC2							
Station Synchronising Intervals (SI) after 48 hour Shutdown	Mins		-	-	-	-	-	-	
Synchronising Group (if applicable)	1 to 4	OC2							-

DATA DESCRIPTION	UNITS	DATA CAT.	GENSET OR STATION DATA							
			G1	G2	G3	G4	G5	G6	STN	
Synchronising Generation (SYG) after 48 hour Shutdown	MW	DPD & OC2								-
De-Synchronising Intervals (Single value)	Mins	OC2	-	-	-	-	-	-	-	-
<u>RUNNING AND SHUTDOWN PERIOD LIMITATIONS:</u>										
Minimum Non Zero time (MNZT) after 48 hour Shutdown	Mins	OC2								
Minimum Zero time (MZT)	Mins	OC2								
Two Shifting Limit (max. per day)	No.	OC2								
Existing AGR Plant Flexibility Limit (Existing AGR Plant only)	No.	OC2								
80% Reactor Thermal Power (expressed as Gross-Net MW) (Existing AGR Plant only)	MW	OC2								
Frequency Sensitive AGR Unit Limit (Frequency Sensitive AGR Units only)	No.	OC2								
<u>RUN-UP PARAMETERS</u>										
Run-up rates (RUR) after 48 hour Shutdown: (See note 2 page 3) MW Level 1 (MWL1) MW Level 2 (MWL2)			(Note that for DPD only a single value of run-up rate from Synch Gen to Registered Capacity is required)							
	MW	OC2								-
	MW	OC2								-
		DPD & OC2								
RUR from Synch. Gen to MWL1	MW/Mins	OC2								
RUR from MWL1 to MWL2	MW/Mins	OC2								
RUR from MWL2 to RC	MW/Mins	OC2								
<u>Run-Down Rates (RDR):</u>										
(Note that for DPD only a single value of run-down rate from Registered Capacity to de-synch is required)										
MWL2 RDR from RC to MWL2	MW MW/Min	OC2 DPD & OC2								
MWL1 RDR from MWL2 to MWL1	MW MW/Min	OC2								
RDR from MWL1 to de-synch	MW/Min	OC2								

DATA DESCRIPTION	UNITS	DATA CAT.	GENSET OR STATION DATA						
			G1	G2	G3	G4	G5	G6	STN
REGULATION PARAMETERS									
Regulating Range Load rejection capability while still Synchronised and able to supply Load .	MW MW	DPD DPD							
GAS TURBINE LOADING PARAMETERS:									
Fast loading Slow loading	MW/Min MW/Min	OC2 OC2							
CCGT MODULE PLANNING MATRIX									
POWER PARK MODULE PLANNING MATRIX									
Power Park Module Active Power Output/ Intermittent Power Source Curve (eg MW output / Wind speed)		OC2	(please attach)						

NOTES:

1. To allow for different groups of **Gensets** within a **Power Station** (eg. **Gensets** with the same operator) each **Genset** may be allocated to one of up to four **Synchronising Groups**. Within each such **Synchronising Group** the single synchronising interval will apply but between **Synchronising Groups** a zero synchronising interval will be assumed.
2. The run-up of a **Genset** from synchronising block load to **Registered Capacity** is represented as a three stage characteristic in which the run-up rate changes at two intermediate loads, MWL1 and MWL2. The values MWL1 & MWL2 can be different for each **Genset**.

LARGE POWER STATION OUTAGE PROGRAMMES, OUTPUT USABLE AND INFLEXIBILITY INFORMATION

(Also outline information on contracts involving **External Interconnections**)

For a **Generating Unit at a Large Power Station** the information is to be submitted on a unit basis and for a **CCGT Module** or **Power Park Module** at a **Large Power Station** the information is to be submitted on a module basis, unless otherwise stated

DATA DESCRIPTION	UNITS	TIME COVERED	UPDATE TIME	DATA CAT.
Power Station name: Generating Unit (or CCGT Module or Power Park Module at a Large Power Station) number:.... Registered Capacity:				
Large Power Station OUTAGE PROGRAMME	Large Power Station OUTPUT USABLE			
<u>PLANNING FOR YEARS 3 - 7 AHEAD</u>				
Provisional outage programme comprising: duration preferred start earliest start latest finish	Monthly average OU	MW	F. yrs 5 - 7 C. yrs 3 - 5	Week 24 Week 2
		weeks	"	"
		date	"	"
		date	"	"
		date	"	"
	Weekly OU	MW	"	"
	(NGET response as detailed in OC2 (Users' response to NGET suggested changes or potential outages)		C. yrs 3 - 5 C. yrs 3 - 5	Week12) Week14)
Updated provisional outage programme comprising: duration preferred start earliest start latest finish			C. yrs 3 - 5	Week 25
		weeks	"	"
		date	"	"
		date	"	"
		date	"	"
	Updated weekly OU	MW	"	"
	(NGET response as detailed in OC2 for (Users' response to NGET suggested changes or update of potential outages)		C. yrs 3 - 5 C. yrs 3 - 5	Week28) Week31)
	(NGET further suggested revisions etc. (as detailed in OC2 for		C. yrs 3 - 5	Week42)
Agreement of final Generation Outage Programme			C. yrs 3 - 5	Week 45
<u>PLANNING FOR YEARS 1 - 2 AHEAD</u>				
Update of previously agreed Final Generation Outage Programme			C. yrs 1 - 2	Week 10
	Weekly OU	MW	"	"

DATA DESCRIPTION	UNITS	TIME COVERED	UPDATE TIME	DATA CAT.
(NGET response as detailed in OC2 for (Users' response to NGET suggested changes or update of potential outages)		C. yrs 1 - 2 C. yrs 1 - 2	Week 12) Week 14)	
Revised weekly OU		C. yrs 1 - 2	Week 34	OC2
(NGET response as detailed in OC2 for (Users' response to NGET suggested changes or update of potential outages)		C. yrs 1 - 2 C. yrs 1 - 2	Week 39) Week 46)	
Agreement of final Generation Outage Programme		C. yrs 1 - 2	Week 48	OC2
<u>PLANNING FOR YEAR 0</u>				
Updated Final Generation Outage Programme		C. yr 0 Week 2 ahead to year end	1600 Weds.	OC2
OU at weekly peak	MW	"	"	"
(NGET response as detailed in OC2 for (C. yrs 0 Weeks 2 to 52 ahead	1600) Friday)	
(Weeks 2 - 7 ahead	1600) Thurs)	
Forecast return to services (Planned Outage or breakdown)	date	days 2 to 14 ahead	0900 daily	OC2
OU (all hours)	MW	"	"	OC2
(NGET response as detailed in OC2 for (days 2 to 14 ahead	1600) daily)	
<u>INFLEXIBILITY</u>				
Genset inflexibility	Min MW (Weekly)	Weeks 2 - 8 ahead	1600 Tues	OC2
(NGET response on Negative Reserve Active (Power Margin		"	1200) Friday)	
Genset inflexibility	Min MW (daily)	days 2 -14 ahead	0900 daily	OC2
(NGET response on Negative Reserve Active (Power Margin		"	1600) daily)	

DATA DESCRIPTION	UNITS	TIME COVERED	UPDATE TIME	DATA CAT.
<p style="text-align: center;"><u>OUTPUT PROFILES</u></p> <p>In the case of Large Power Stations whose output may be expected to vary in a random manner (eg. wind power) or to some other pattern (eg. Tidal) sufficient information is required to enable an understanding of the possible profile</p>	MW	F. yrs 1 - 7	Week 24	SPD

Notes: 1. The week numbers quoted in the Update Time column refer to standard weeks in the current year.

GOVERNOR DROOP AND RESPONSE

The Data in this Schedule 4 is to be supplied by **Generators** with respect to all **Large Power Stations** and by **DC Converter Station owners** (where agreed), whether directly connected or **Embedded**

DATA DESCRIPTION	NORMAL VALUE	MW	DATA CAT	DROOP%			RESPONSE CAPABILITY		
				Unit 1	Unit 2	Unit 3	Primary	Secondary	High Frequency
MLP1	Designed Minimum Operating Level (for a CCGT Module or Power Park Module , on a modular basis assuming all units are Synchronised)								
MLP2	Minimum Generation (for a CCGT Module or Power Park Module , on a modular basis assuming all units are								
MLP3	70% of Registered Capacity								
MLP4	80% of Registered Capacity								
MLP5	95% of Registered Capacity								
MLP6	Registered Capacity								

Notes:

1. The data provided in this Schedule 4 is not intended to constrain any **Ancillary Services Agreement**.
2. **Registered Capacity** should be identical to that provided in Schedule 2.
3. The Governor Droop should be provided for each **Generating Unit**(excluding **Power Park Units**), **Power Park Module** or **DC Converter**. The Response Capability should be provided for each **Genset** or **DC Converter**.
4. **Primary**, **Secondary** and **High Frequency Response** are defined in CC.A.3.2 and are based on a frequency ramp of 0.5Hz over 10 seconds. **Primary Response** is the minimum value of response between 10s and 30s after the frequency ramp starts. **Secondary Response** between 30s and 30 minutes, and **High Frequency Response** is the minimum value after 10s on an indefinite basis.
5. For plants which have not yet **Synchronised**, the data values of MLP1 to MLP6 should be as described above. For plants which have already **Synchronised**, the values of MLP1 to MLP6 can take any value between **Designed Operating Minimum Level** and **Registered Capacity**. If MLP1 is not provided at the **Designed Minimum Operating Level**, the value of the **Designed Minimum Operating Level** should be separately stated.

USERS SYSTEM DATA

The data in this Schedule 5 is required from **Users** who are connected to the **GB Transmission System** via a **Connection Point** (or who are seeking such a connection)

DATA DESCRIPTION	UNITS	DATA CATEGORY
<p><u>USERS SYSTEM LAYOUT</u></p> <p>A Single Line Diagram showing all or part of the User’s System is required. This diagram shall include:-</p> <ul style="list-style-type: none"> (a) all parts of the User’s System, whether existing or proposed, operating at Supergrid Voltage, and in Scotland, also all parts of the User System operating at 132kV, (b) all parts of the User’s System operating at a voltage of 50kV, and in Scotland greater than 30kV, or higher which can interconnect Connection Points, or split bus-bars at a single Connection Point, (c) all parts of the User’s System between Embedded Medium Power Stations or Large Power Stations connected to the User’s Subtransmission System and the relevant Connection Point, (d) all parts of the User’s System at a Transmission Site. <p>The Single Line Diagram may also include additional details of the User’s Subtransmission System, and the transformers connecting the User’s Subtransmission System to a lower voltage. With NGET’s agreement, it may also include details of the User’s System at a voltage below the voltage of the Subtransmission System.</p> <p>This Single Line Diagram shall depict the arrangement(s) of all of the existing and proposed load current carrying Apparatus relating to both existing and proposed Connection Points, showing electrical circuitry (ie. overhead lines, underground cables, power transformers and similar equipment), operating voltages. In addition, for equipment operating at a Supergrid Voltage, and in Scotland also at 132kV, circuit breakers and phasing arrangements shall be shown.</p>		<p>SPD</p>

USERS SYSTEM DATA

DATA DESCRIPTION	UNITS	DATA CATEGORY
REACTIVE COMPENSATION		
For independently switched reactive compensation equipment not owned by a Transmission Licensee connected to the User's System at 132kV and above, and also in Scotland, connected at 33kV and above, other than power factor correction equipment associated with a customers Plant or Apparatus :		
Type of equipment (eg. fixed or variable)	Text	SPD
Capacitive rating; or	Mvar	SPD
Inductive rating; or	Mvar	SPD
Operating range	Mvar	SPD
Details of automatic control logic to enable operating characteristics to be determined	text and/or diagrams	SPD
Point of connection to User's System (electrical location and system voltage)	Text	SPD
SUBSTATION INFRASTRUCTURE		
For the infrastructure associated with any User's equipment at a Substation owned by a Transmission Licensee or operated or managed by NGET :-		
Rated 3-phase rms short-circuit withstand current	kA	SPD
Rated 1-phase rms short-circuit withstand current	kA	SPD
Rated Duration of short-circuit withstand	s	SPD
Rated rms continuous current	A	SPD

USER'S SYSTEM DATA

Circuit Parameters

The data below is all **Standard Planning Data**. Details are to be given for all circuits shown on the **Single Line Diagram**

Years Valid	Node 1	Node 2	Rated Voltage kV	Operating Voltage kV	Positive Phase Sequence % on 100 MVA			Zero Phase Sequence (self) % on 100 MVA			Zero Phase Sequence (mutual) % on 100 MVA									
					R	X	B	R	X	B	R	X	B							

Notes

1. Data should be supplied for the current, and each of the seven succeeding Financial Years. This should be done by showing for which years the data is valid in the first column of the Table.

USER'S SYSTEM DATA
Switchgear Data

The data below is all **Standard Planning Data**, and should be provided for all switchgear (ie. circuit breakers, load disconnectors and disconnectors) operating at a **Supergrid Voltage**, and also in Scotland, operating at 132kV. In addition, data should be provided for all circuit breakers irrespective of voltage located at a **Connection Site** which is owned by a **Transmission Licensee** or operated or managed by **NGET**.

Years Valid	Connect-ion Point	Switch No.	Rated Voltage kV rms	Operating Voltage kV rms	Rated short-circuit breaking current		Rated short-circuit peak making current		Rated rms continuous current (A)	DC time constant at testing of asymmetrical breaking ability(s)
					3 Phase kA rms	1 Phase kA rms	3 Phase kA peak	1 Phase kA peak		

Notes

1. Rated Voltage should be as defined by IEC 694.
2. Data should be supplied for the current, and each of the seven succeeding Financial Years. This should be done by showing for which years the data is valid in the first column of the Table

USERS SYSTEM DATA

DATA DESCRIPTION	UNITS	DATA CATEGORY
<u>PROTECTION SYSTEMS</u>		
The following information relates only to Protection equipment which can trip or inter-trip or close any Connection Point circuit breaker or any GB Transmission System circuit breaker. The information need only be supplied once, in accordance with the timing requirements set out in PC.A.1.4 (b) and need not be supplied on a routine annual thereafter, although NGET should be notified if any of the information changes.		
(a) A full description, including estimated settings, for all relays and Protection systems installed or to be installed on the User's System ;		DPD
(b) A full description of any auto-reclose facilities installed or to be installed on the User's System , including type and time delays;		DPD
(c) A full description, including estimated settings, for all relays and Protection systems installed or to be installed on the Power Park Module or Generating Unit's generator transformer, unit transformer, station transformer and their associated connections;		DPD
(d) For Generating Units (other than Power Park Units) having a circuit breaker at the generator terminal voltage clearance times for electrical faults within the Generating Unit zone must be declared.		DPD
(e) Fault Clearance Times: Most probable fault clearance time for electrical faults on any part of the Users System directly connected to the GB Transmission System .	mSec	DPD

DATA DESCRIPTION	UNITS	DATA CATEGORY
<u>POWER PARK MODULE/UNIT PROTECTION SYSTEMS</u>		
Details of settings for the Power Park Module/Unit protection relays (to include):		
(a) Under frequency,		DPD
(b) Over Frequency,		DPD
(c) Under Voltage, Over Voltage,		DPD
(d) Rotor Over current		DPD
(e) Stator Over current,		DPD
(f) High Wind Speed Shut Down Level		DPD

USER'S SYSTEM DATA

Information for Transient Overvoltage Assessment (DPD)

The information listed below may be requested by **NGET** from each **User** with respect to any **Connection Site** between that **User** and the **GB Transmission System**. The impact of any third party **Embedded** within the **Users System** should be reflected.

- (a) Busbar layout plan(s), including dimensions and geometry showing positioning of any current and voltage transformers, through bushings, support insulators, disconnectors, circuit breakers, surge arresters, etc. Electrical parameters of any associated current and voltage transformers, stray capacitances of wall bushings and support insulators, and grading capacitances of circuit breakers;
- (b) Electrical parameters and physical construction details of lines and cables connected at that busbar. Electrical parameters of all plant e.g., transformers (including neutral earthing impedance or zig-zag transformers if any), series reactors and shunt compensation equipment connected at that busbar (or to the tertiary of a transformer) or by lines or cables to that busbar;
- (c) Basic insulation levels (BIL) of all **Apparatus** connected directly, by lines or by cables to the busbar;
- (d) Characteristics of overvoltage **Protection** devices at the busbar and at the termination points of all lines, and all cables connected to the busbar;
- (e) Fault levels at the lower voltage terminals of each transformer connected directly or indirectly to the **GB Transmission System** without intermediate transformation;
- (f) The following data is required on all transformers operating at **Supergrid Voltage** and also in Scotland, operating at 132kV: three or five limb cores or single phase units to be specified, and operating peak flux density at nominal voltage.
- (g) An indication of which items of equipment may be out of service simultaneously during **Planned Outage** conditions.

Harmonic Studies (DPD)

The information given below, both current and forecast, where not already supplied in this Schedule 5 may be requested by **NGET** from each **User** if it is necessary for **NGET** to evaluate the production/magnification of harmonic distortion on **GB Transmission System** and **User's** systems. The impact of any third party **Embedded** within the **User's System** should be reflected:-

- (a) Overhead lines and underground cable circuits of the **User's Subtransmission System** must be differentiated and the following data provided separately for each type:-
 - Positive phase sequence resistance
 - Positive phase sequence reactance
 - Positive phase sequence susceptance
- (b) for all transformers connecting the **User's Subtransmission System** to a lower voltage:-
 - Rated MVA
 - Voltage Ratio
 - Positive phase sequence resistance
 - Positive phase sequence reactance
- (c) at the lower voltage points of those connecting transformers:-
 - Equivalent positive phase sequence susceptance
 - Connection voltage and Mvar rating of any capacitor bank and component design parameters if configured as a filter

Equivalent positive phase sequence interconnection impedance with other lower voltage points
 The Minimum and maximum **Demand** (both MW and Mvar) that could occur
 Harmonic current injection sources in Amps at the Connection voltage points
 Details of traction loads, eg connection phase pairs, continuous variation with time, etc.

- (d) an indication of which items of equipment may be out of service simultaneously during **Planned Outage** conditions

Voltage Assessment Studies (DPD)

The information listed below, where not already supplied in this Schedule 5, may be requested by **NGET** from each **User** with respect to any **Connection Site** if it is necessary for **NGET** to undertake detailed voltage assessment studies (eg to examine potential voltage instability, voltage control co-ordination or to calculate voltage step changes). The impact of any third party **Embedded** within the **Users System** should be reflected:-

- (a) For all circuits of the **User's Subtransmission System**:-

Positive Phase Sequence Reactance
 Positive Phase Sequence Resistance
 Positive Phase Sequence Susceptance
 Mvar rating of any reactive compensation equipment

- (b) for all transformers connecting the **User's Subtransmission System** to a lower voltage:-

Rated MVA
 Voltage Ratio
 Positive phase sequence resistance
 Positive Phase sequence reactance
 Tap-changer range
 Number of tap steps
 Tap-changer type: on-load or off-circuit
 AVC/tap-changer time delay to first tap movement
 AVC/tap-changer inter-tap time delay

- (c) at the lower voltage points of those connecting transformers:-

Equivalent positive phase sequence susceptance
 Mvar rating of any reactive compensation equipment
 Equivalent positive phase sequence interconnection impedance with other lower voltage points
 The maximum **Demand** (both MW and Mvar) that could occur
 Estimate of voltage insensitive (constant power) load content in % of total load at both winter peak and 75% off-peak load conditions

Short Circuit Analyses:(DPD)

The information listed below, both current and forecast, and where not already supplied under this Schedule 5, may be requested by **NGET** from each **User** with respect to any **Connection Site** where prospective short-circuit currents on equipment owned by a **Transmission Licensee** or operated or managed by **NGET** are close to the equipment rating. The impact of any third party **Embedded** within the **User's System** should be reflected:-

- (a) For all circuits of the **User's Subtransmission System**:-

Positive phase sequence resistance
 Positive phase sequence reactance
 Positive phase sequence susceptance
 Zero phase sequence resistance (both self and mutuals)
 Zero phase sequence reactance (both self and mutuals)
 Zero phase sequence susceptance (both self and mutuals)

- (b) for all transformers connecting the **User's Subtransmission System** to a lower voltage:-

Rated MVA

Voltage Ratio

Positive phase sequence resistance (at max, min and nominal tap)

Positive Phase sequence reactance (at max, min and nominal tap)

Zero phase sequence reactance (at nominal tap)

Tap changer range

Earthing method: direct, resistance or reactance

Impedance if not directly earthed

- (c) at the lower voltage points of those connecting transformers:-

The maximum **Demand** (in MW and Mvar) that could occur

Short-circuit infeed data in accordance with PC.A.2.5.6(a) unless the **User's** lower voltage network runs in parallel with the **Subtransmission System**, when to prevent double counting in each node infeed data, a π equivalent comprising the data items of PC.A.2.5.6(a) for each node together with the positive phase sequence interconnection impedance between the nodes shall be submitted.

USERS OUTAGE INFORMATION

DATA DESCRIPTION	UNITS	TIMESCALE COVERED	UPDATE TIME	DATA CAT.
Details are required from Network Operators of proposed outages in their User Systems and from Generators with respect to their outages, which may affect the performance of the Total System (eg. at a Connection Point or constraining Embedded Large Power Stations)		Years 2-5	Week 8 (Network Operator etc) Week 13 (Generators)	OC2 OC2
(NGET advises Network Operators of GB Transmission System outages (affecting their Systems		Years 2-5	Week 28))	
Network Operator informs NGET if unhappy with proposed outages)		"	Week 30	OC2
(NGET draws up revised GB Transmission System (outage plan advises Users of operational effects		"	Week 34))	
Generators and Non-Embedded Customers provide Details of Apparatus owned by them (other than Gensets) at each Grid Supply Point		Year 1	Week 13	OC2
(NGET advises Network Operators of outages affecting (their Systems		Year 1	Week 28))	
Network Operator details of relevant outages affecting the Total System		Year 1	Week 32	OC2
(NGET informs Users of aspects that may affect (their Systems		Year 1	Week 34))	
Users inform NGET if unhappy with aspects as notified		Year 1	Week 36	OC2
(NGET issues final GB Transmission System (outage plan with advice of operational (effects on Users System		Year 1	Week 49	OC2))
Generator, Network Operator and Non-Embedded Customers to inform NGET of changes to outages previously requested		Week 8 ahead to year end	As occurring	OC2
Details of load transfer capability of 12MW or more between Grid Supply Points in England and Wales and 10MW or more between Grid Supply Points in Scotland.		Within Yr 0	As NGET request	OC2

Note: **Users** should refer to **OC2** for full details of the procedure summarised above and for the information which **NGET** will provide on the **Programming Phase**.

LOAD CHARACTERISTICS AT GRID SUPPLY POINTS

All data in this schedule 7 is categorised as **Standard Planning Data (SPD)** and is required for existing and agreed future connections. This data is only required to be updated when requested by **NGET**.

DATA DESCRIPTION	UNITS	DATA FOR FUTURE YEARS						
		Yr 1	Yr 2	Yr 3	Yr 4	Yr 5	Yr 6	Yr 7
<p>FOR ALL TYPES OF DEMAND FOR EACH GRID SUPPLY POINT</p> <p>The following information is required infrequently and should only be supplied, wherever possible, when requested by NGET</p> <p>Details of individual loads which have Characteristics significantly different from the typical range of domestic or commercial and industrial load supplied:</p> <p>Sensitivity of demand to fluctuations in voltage And frequency on GB Transmission System at time of peak Connection Point Demand (Active Power)</p> <p>Voltage Sensitivity</p> <p>Frequency Sensitivity</p> <p>Reactive Power sensitivity should relate to the Power Factor information given in Schedule 11 (or for Generators, Schedule 1) and note 6 on Schedule 11 relating to Reactive Power therefore applies:</p> <p>Phase unbalance imposed on the GB Transmission System</p> <ul style="list-style-type: none"> - maximum - average <p>Maximum Harmonic Content imposed on GB Transmission System</p> <p>Details of any loads which may cause Demand Fluctuations greater than those permitted under Engineering Recommendation P28, Stage 1 at the Point of Common Coupling including Flicker Severity (Short Term) and Flicker Severity (Long Term)</p>	<p>MW/kV Mvar/kV</p> <p>MW/Hz Mvar/Hz</p> <p>%</p> <p>%</p> <p>%</p>							
		(Please Attach)						

DATA SUPPLIED BY BM PARTICIPANTS

CODE	DESCRIPTION
BC1	Physical Notifications
BC1	Quiescent Physical Notifications
BC1 & BC2	Export and Import Limits
BC1	Bid-Offer Data
BC1	Dynamic Parameters (Day Ahead)
BC2	Dynamic Parameters (For use in Balancing Mechanism)
BC1 & BC2	Other Relevant Data
BC1	Joint BM Unit Data

DATA SUPPLIED BY NGET TO USERS

(Example of data to be supplied)

CODE	DESCRIPTION
CC	Operation Diagram
CC	Site Responsibility Schedules
PC	Day of the peak GB Transmission System Demand Day of the minimum GB Transmission System Demand
OC2	Surpluses and OU requirements for each Generator over varying timescales Equivalent networks to Users for Outage Planning Negative Reserve Active Power Margins (when necessary) Operating Reserve information
BC1	Demand Estimates, Indicated Margin and Indicated Imbalance , indicative Synchronising and Desynchronising times of Embedded Power Stations to Network Operators , special actions.
BC2	Bid-Offer Acceptances , Ancillary Services instructions to relevant Users , Emergency Instructions
BC3	Location, amount, and Low Frequency Relay settings of any Low Frequency Relay initiated Demand reduction for Demand which is Embedded .

DATA TO BE SUPPLIED BY NGET TO USERS

PURSUANT TO THE TRANSMISSION LICENCE

1. The **Transmission Licence** requires **NGET** to publish annually the **Seven Year Statement** which is designed to provide **Users** and potential Users with information to enable them to identify opportunities for continued and further use of the **GB Transmission System**.

When a **User** is considering a development at a specific site, certain additional information may be required in relation to that site which is of such a level of detail that it is inappropriate to include it in the **Seven Year Statement**. In these circumstances the **User** may contact **NGET** who will be pleased to arrange a discussion and the provision of such additional information relevant to the site under consideration as the **User** may reasonably require.

2. The **Transmission Licence** also requires **NGET** to offer terms for an agreement for connection to and use of the **GB Transmission System** and further information will be given by **NGET** to the potential **User** in the course of the discussions of the terms of such an agreement.

DEMAND PROFILES AND ACTIVE ENERGY DATA

The following information is required from each **Network Operator** and from each **Non-Embedded Customer**. The data should be provided in calendar week 24 each year (although **Network Operators** may delay the submission until calendar week 28).

DATA DESCRIPTION	F. Yr. 0	F. Yr. 1	F. Yr. 2	F. Yr. 3	F. Yr. 4	F. Yr. 5	F. Yr. 6	F. Yr. 7	UPDATE TIME	DATA CAT
<u>Demand Profiles</u>										
Total User's system profile (please delete as applicable)	Day of User's annual Maximum demand at Annual ACS Conditions (MW) Day of annual peak of GB Transmission System Demand at Annual ACS Conditions (MW) Day of annual minimum GB Transmission System Demand at average conditions (MW)									
0000 : 0030									Wk.24	SPD
0030 : 0100									:	:
0100 : 0130									:	:
0130 : 0200									:	:
0200 : 0230									:	:
0230 : 0300									:	:
0300 : 0330									:	:
0330 : 0400									:	:
0400 : 0430									:	:
0430 : 0500									:	:
0500 : 0530									:	:
0530 : 0600									:	:
0600 : 0630									:	:
0630 : 0700									:	:
0700 : 0730									:	:
0730 : 0800									:	:
0800 : 0830									:	:
0830 : 0900									:	:
0900 : 0930									:	:
0930 : 1000									:	:
1000 : 1030									:	:
1030 : 1100									:	:
1100 : 1130									:	:
1130 : 1200									:	:
1200 : 1230									:	:
1230 : 1300									:	:
1300 : 1330									:	:
1330 : 1400									:	:
1400 : 1430									:	:
1430 : 1500									:	:
1500 : 1530									:	:
1530 : 1600									:	:
1600 : 1630									:	:
1630 : 1700									:	:
1700 : 1730									:	:
1730 : 1800									:	:
1800 : 1830									:	:
1830 : 1900									:	:
1900 : 1930									:	:
1930 : 2000									:	:
2000 : 2030									:	:
2030 : 2100									:	:
2100 : 2130									:	:
2130 : 2200									:	:
2200 : 2230									:	:
2230 : 2300									:	:
2300 : 2330									:	:
2330 : 0000									:	:

DATA DESCRIPTION	Out-turn		F.Yr. 0	Update Time	Data Cat
	Actual	Weath corr.			
<p><u>Active Energy Data</u></p> <p>Total annual Active Energy requirements under average conditions of each Network Operator and each Non-Embedded Customer in the following categories of Customer Tariff:-</p> <p style="padding-left: 40px;">LV1 LV2 LV3 EHV HV Traction Lighting User System Losses</p> <p>Active Energy from Embedded Small Power Stations and Embedded Medium Power Stations</p>				Week 24	SPD

NOTES:

1. 'F. yr.' means '**Financial Year**'
2. **Demand and Active Energy Data (General)**

Demand and **Active Energy** data should relate to the point of connection to the **GB Transmission System** and should be net of the output (as reasonably considered appropriate by the **User**) of all **Embedded Small Power Stations, Medium Power Stations** and **Customer Generating Plant**. Auxiliary demand of **Embedded Power Stations** should be included in the demand data submitted by the **User** at the **Connection Point**. **Users** should refer to the **PC** for a full definition of the **Demand** to be included.
3. **Demand** profiles and **Active Energy** data should be for the total **System** of the **Network Operator**, including all **Connection Points**, and for each **Non-Embedded Customer**. **Demand Profiles** should give the numerical maximum demand that in the **User's** opinion could reasonably be imposed on the **GB Transmission System**.
4. In addition the demand profile is to be supplied for such days as **NGET** may specify, but such a request is not to be made more than once per calendar year.

DATA REGISTRATION CODE

CONNECTION POINT DATA

The following information is required from each **Network Operator** and from each **Non-Embedded Customer**. The data should be provided in calendar week 24 each year (although **Network Operators** may delay the submission until calendar week 28).

DATA DESCRIPTION	F.Yr 0	F.Yr 1	F.Yr 2	F.Yr. 3	F.Yr. 4	F.Yr. 5	F.Yr 6	F.Yr 7	UPDATE TIME	DATA CAT
SPECIFIC HALF HOUR DEMANDS AND POWER FACTORS (see Notes 2, 3 and 5)										
Individual Connection Point Demands and Power Factor at : (name of GSP)										
The annual peak half hour at the Connection Point at Annual ACS Conditions	MW	-	-	-	-	-	-	-	Wk.24	SPD
	p.f.	-	-	-	-	-	-	-	Wk.24	SPD
Lumped Susceptance (See Note 6. This data item is not required if a Single Line Diagram associated with the Connection Point has been provided)		-	-	-	-	-	-	-	Wk.24	SPD
Deduction made for Small Power Stations, Medium Power Stations and Customer Generating Plant (MW)		-	-	-	-	-	-	-	Wk.24	SPD
The specified time of the annual peak half hour of GB Transmission System Demand at Annual ACS Conditions	MW	-	-	-	-	-	-	-	Wk.24	SPD
	p.f.	-	-	-	-	-	-	-	Wk.24	SPD
Deduction made for Small Power Stations, Medium Power Stations and Customer Generating Plant (MW)		-	-	-	-	-	-	-	Wk.24	SPD
The specified time of the annual minimum half hour of the GB Transmission System Demand	MW	-	-	-	-	-	-	-	Wk.24	SPD
	p.f.	-	-	-	-	-	-	-	Wk.24	SPD
Deduction made for Small Power Stations, Medium Power Stations and Customer Generating Plant		-	-	-	-	-	-	-	Wk.24	SPD
For such other times as NGET may specify	MW	-	-	-	-	-	-	-	Once p.a. max.	SPD
	p.f.	-	-	-	-	-	-	-		SPD
Deduction made for Small Power Stations, Medium Power Stations and Customer Generating Plant		-	-	-	-	-	-	-	Once p.a.	
		-	-	-	-	-	-	-	Max.	SPD

DATA DESCRIPTION	F.Yr 1	F.Yr 2	F.Yr 3	F.Yr 4	F.Yr 5	F.Yr 6	F.Yr 7	UPDATE TIME	DATA CAT
<p><u>DEMAND TRANSFER CAPABILITY (PRIMARY SYSTEM)</u></p> <p>Where a User's Demand, or group of Demands, may be fed from alternative Connection Point(s) the following information should be provided</p> <p><u>First circuit outage (fault outage) condition</u></p> <p>Name of the alternative Connection Point(s)</p> <p>Demand transferred (MW) (Mvar)</p> <p>Transfer arrangement i.e Manual (M) Interconnection (I) Automatic (A)</p> <p>Time to effect transfer (hrs)</p> <p><u>Second Circuit outage (planned outage) condition</u></p> <p>Name of the alternative Connection Point(s)</p> <p>Demand transferred (MW) (Mvar)</p> <p>Transfer arrangement i.e Manual (M) Interconnection (I) Automatic (A)</p> <p>Time to effect transfer (hrs)</p>								Wk.24	SPD
								Wk.24	SPD
								Wk.24	SPD
								Wk.24	SPD
								Wk.24	SPD
								Wk.24	SPD
								Wk.24	SPD
								Wk.24	SPD
								Wk.24	SPD

The above demand transfer capability information for specific **Grid Supply Points** is to be updated during the current year - see Schedule 6.

DATA DESCRIPTION	F.Yr 0	F.Yr 1	F.Yr. 2	F.Yr. 3	F.Yr 4	F.Yr. 5	F.Yr. 6	F.Yr 7	UPDATE TIME	DATA CAT	
<u>SMALL POWER STATION, MEDIUM POWER STATION AND CUSTOMER GENERATION SUMMARY</u> For each Connection Point where there are Embedded Small Power Stations, Medium Power Stations or Customer Generating Stations the following information is required: No. of Small Power Stations, Medium Power Stations or Customer Power Stations Number of Generating Units within these stations Summated Capacity of all these Generating Units Where the Network Operator's System places a constraint on the capacity of an Embedded Large Power Station									Wk.24	SPD	
									Wk.24	SPD	
									Wk.24	SPD	
Station Name Generating Unit									Wk.24 Wk.24	SPD SPD	
									Wk.24	SPD	
System Constrained Capacity											
For each Single Line Diagram provided under Schedule 5, nodal Demands, Power Factors and lumped susceptances are to be provided for the specified time of the annual peak half hour of GB Transmission System Demand at Annual ACS Conditions:	Connection Point				Year				Wk.24	SPD	
	Node		Demand	Power Factor		Lumped Susceptance					

NOTES:

1. 'F.Yr.' means '**Financial Year**'. F.Yr. 1 refers to the current financial year.
2. **Demand Data (General)**

All **Demand** data should be net of the output (as reasonably considered appropriate by the **User**) of all **Embedded Small Power Stations, Medium Power Stations** and **Customer Generating Plant**. **Demand** met by **Suppliers** supplying **Customers** within the **User System** should be included. Auxiliary demand of **Embedded Power Stations** should not be included in the demand data submitted by the **User**. **Users** should refer to the **PC** for a full definition of the **Demand** to be included.

3. Peak **Demands** should relate to each **Connection Point** individually and should give the maximum demand that in the **User's** opinion could reasonably be imposed on the **GB Transmission System**. Where the busbars on a **Connection Point** are expected to be run in separate sections separate **Demand** data should be supplied for each such section of busbar.

In deriving **Demands** any deduction made by the **User** (as detailed in note 2 above) to allow for **Embedded Small Power Stations, Medium Power Stations** and **Customer Generating Plant** is to be specifically stated as indicated on the Schedule.

4. **NGET** may at its discretion require details of any **Embedded Small Power Stations** or **Embedded Medium Power Stations** whose output can be expected to vary in a random manner (eg. wind power) or according to some other pattern (eg. tidal power)
5. Where more than 95% of the total **Demand** at a **Connection Point** is taken by synchronous motors, values of the **Power Factor** at maximum and minimum continuous excitation may be given instead.
6. **Power Factor** data should allow for series reactive losses on the **User's System** but exclude reactive compensation specified separately in Schedule 5, and any network susceptance provided under Schedule 11.

DEMAND CONTROL

The following information is required from each **Network Operator** and where indicated with an asterisk from **Externally Interconnected System Operators** and/or **Interconnector Users** and a **Pumped Storage Generator**. Where indicated with a double asterisk, the information is only required from **Suppliers**.

DATA DESCRIPTION	UNITS		UPDATE TIME	
<u>Demand Control</u>				
Demand met or to be relieved by Demand Control (averaging at the Demand Control Notification Level or more over a half hour) at each Connection Point .				
Demand Control at time of GB Transmission System weekly peak demand				
amount duration	MW Min)F.yrs 0 to 5)	Week 24	OC1
For each half hour	MW	Wks 2-8 ahead	1000 Mon	OC1
For each half hour	MW	Days 2-12 ahead	1200 Wed	OC1
For each half hour	MW	Previous calendar day	0600 daily	OC1
<u>**Customer Demand Management</u> (at the Customer Demand Management Notification Level or more at the Connection Point)				
For each half hour	MW	Any time in Control Phase		OC1
For each half hour	MW	Remainder of period	When changes occur to previous plan	OC1
For each half hour	MW	Previous calendar day	0600 daily	OC1
**In Scotland, Load Management Blocks				
For each block of 5MW or more, for each half hour	MW	For the next day	11:00	OC1

DATA DESCRIPTION	UNITS	TIME COVERED	UPDATE TIME	DATA CAT.
*Demand Control or Pump Tripping Offered as Reserve				
Magnitude of Demand or pumping load which is tripped	MW	Year ahead from week 24	Week 24	DPD
System Frequency at which tripping is initiated	Hz	"	"	"
Time duration of System Frequency below trip setting for tripping to be initiated	S	"	"	"
Time delay from trip initiation to Tripping	S	"	"	"
Emergency Manual Load Disconnection				
Method of achieving load disconnection	Text	Year ahead from week 24	Annual in week 24	OC6
Annual ACS Peak Demand (Active Power) at Connection Point (requested under Schedule 11 - repeated here for reference)	MW	"	"	"
Cumulative percentage of Connection Point Demand (Active Power) which can be disconnected by the following times from an instruction from NGET				
5 mins	%	"	"	"
10 mins	%	"	"	"
15 mins	%	"	"	"
20 mins	%	"	"	"
25 mins	%	"	"	"
30 mins	%	"	"	"
Automatic Low Frequency Disconnection				
Magnitude of Demand disconnected, and frequency at which Disconnection is initiated, for each frequency setting for each Grid Supply Point	MW Hz	Year ahead from week 24	Annual in week 24	OC6

Notes

1. **Network Operators** may delay the submission until calendar week 28.

FAULT INFEED DATA

The data in this Schedule 13 is all **Standard Planning Data**, and is required from all **Users** other than **Generators** who are connected to the **GB Transmission System** via a **Connection Point** (or who are seeking such a connection). A data submission is to be made each year in Week 24 (although **Network Operators** may delay the submission until Week 28). A separate submission is required for each node included in the **Single Line Diagram** provided in Schedule 5.

DATA DESCRIPTION	UNITS	F.Yr 0	F.Yr. 1	F.Yr. 2	F.Yr. 3	F.Yr. 4	F.Yr. 5	F.Yr. 6	F.Yr. 7
SHORT CIRCUIT INFEED TO THE GB TRANSMISSION SYSTEM FROM USERS SYSTEM AT A CONNECTION POINT									
Name of node or Connection Point									
Symmetrical three phase short-circuit current infeed									
- at instant of fault	kA								
- after subtransient fault current contribution has substantially decayed	kA								
Zero sequence source impedances as seen from the Point of Connection or node on the Single Line Diagram (as appropriate) consistent with the maximum infeed above:									
- Resistance	% on 100								
- Reactance	% on 100								
Positive sequence X/R ratio at instance of fault									
Pre-Fault voltage magnitude at which the maximum fault currents were calculated	p.u.								
Negative sequence impedances of User's System as seen from the Point of Connection or node on the Single Line Diagram (as appropriate). If no data is given, it will be assumed that they are equal to the positive sequence values.									
- Resistance	% on 100								
- Reactance	% on 100								

FAULT INFEED DATA

The data in this Schedule 14 is all **Standard Planning Data**, and is to be provided by **Generators**, with respect to all directly connected **Power Stations**, all **Embedded Large Power Stations** and all **Embedded Medium Power Stations** connected to the **Subtransmission System**. A data submission is to be made each year in Week 24.

Fault infeeds via Unit Transformers

A submission should be made for each **Generating Unit** with an associated **Unit Transformer**. Where there is more than one **Unit Transformer** associated with a **Generating Unit**, a value for the total infeed through all **Unit Transformers** should be provided. The infeed through the **Unit Transformer(s)** should include contributions from all motors normally connected to the **Unit Board**, together with any generation (eg **Auxiliary Gas Turbines**) which would normally be connected to the **Unit Board**, and should be expressed as a fault current at the **Generating Unit** terminals for a fault at that location.

DATA DESCRIPTION	UNITS	F.Yr. 0	F.Yr. 1	F.Yr. 2	F.Yr. 3	F.Yr. 4	F.Yr. 5	F.Yr. 6	F.Yr. 7
Name of Power Station									
Number of Unit Transformer									
Symmetrical three phase short-circuit current infeed through the Unit Transformer(s) for a fault at the Generating Unit terminals									
- at instant of fault	kA								
- after subtransient fault current contribution has substantially decayed	kA								
Positive sequence X/R ratio at instance of fault									
Subtransient time constant (if significantly different from 40ms)	ms								
Pre-fault voltage at fault point (if different from 1.0 p.u.)									
The following data items need only be supplied if the Generating Unit Step-up Transformer can supply zero sequence current from the Generating Unit side to the GB Transmission System									
Zero sequence source impedances as seen from the Generating Unit terminals consistent with the maximum infeed above:									
- Resistance	% on 100								
- Reactance	% on 100								

Fault infeeds via Station Transformers

A submission is required for each **Station Transformer** directly connected to the **GB Transmission System**. The submission should represent normal operating conditions when the maximum number of **Gensets** are **Synchronised** to the **System**, and should include the fault current from all motors normally connected to the **Station Board**, together with any Generation (eg **Auxiliary Gas Turbines**) which would normally be connected to the **Station Board**. The fault infeed should be expressed as a fault current at the hv terminals of the **Station Transformer** for a fault at that location.

If the submission for normal operating conditions does not represent the worst case, then a separate submission representing the maximum fault infeed that could occur in practice should be made.

DATA DESCRIPTION	UNITS	F.Yr. 0	F.Yr. 1	F.Yr. 2	F.Yr. 3	F.Yr. 4	F.Yr. 5	F.Yr. 6	F.Yr. 7
Name of Power Station									
Number of Station Transformer									
Symmetrical three phase short-circuit current infeed for a fault at the Connection Point									
- at instant of fault	kA								
- after subtransient fault current contribution has substantially decayed	kA								
Positive sequence X/R ratio At instance of fault									
Subtransient time constant (if significantly different from 40ms)	mS								
Pre-fault voltage (if different from 1.0 p.u.) at fault point (See note 1)									
Zero sequence source Impedances as seen from the Point of Connection Consistent with the maximum Infeed above:									
- Resistance	% on 100								
- Reactance	% on 100								

Note 1. The pre-fault voltage provided above should represent the voltage within the range 0.95 to 1.05 that gives the highest fault current

Note 2. % on 100 is an abbreviation for % on 100 MVA

MOTHBALLED GENERATING UNIT MOTHBALLED POWER PARK MODULE OR MOTHBALLED DC CONVERTER AT A DC CONVERTER STATION INFORMATION

The following data items must be supplied with respect to each **Mothballed Generating Unit**, **Mothballed Power Park Module** or **Mothballed DC Converter** at a **DC Converter station**

Power Station _____ **Generating Unit, Power Park Module or DC Converter Name** (e.g. Unit 1)

DATA DESCRIPTION	UNITS	DATA CAT	GENERATING UNIT DATA					Total MW being returned	
			<1 month	1-2 months	2-3 months	3-6 months	6-12 months		>12 months
MW output that can be returned to service	MW	DPD							

Notes

- The time periods identified in the above table represent the estimated time it would take to return the **Mothballed Generating Unit, Mothballed Power Park Module or Mothballed DC Converter** at a **DC Converter Station** to service once a decision to return has been made.
- Where a **Mothballed Generating Unit, Mothballed Power Park Module or Mothballed DC Converter** at a **DC Converter Station** can be physically returned in stages covering more than one of the time periods identified in the above table then information should be provided for each applicable time period.
- The estimated notice to physically return MW output to service should be determined in accordance with **Good Industry Practice** assuming normal working arrangements and normal plant procurement lead times.
- The MW output values in each time period should be incremental MW values, e.g. if 150MW could be returned in 2 – 3 months and an additional 50MW in 3 – 6 months then the values in the columns should be Nil, Nil, 150, 50, Nil, Nil, 200 respectively.
- Significant factors which may prevent the **Mothballed Generating Unit, Mothballed Power Park Module or Mothballed DC Converter** at a **DC Converter Station** achieving the estimated values provided in this table, excluding factors relating to **Transmission Entry Capacity**, should be appended separately.

ALTERNATIVE FUEL INFORMATION

The following data items for alternative fuels need only be supplied with respect to each **Generating Unit** whose primary fuel is gas.

Power Station _____ **Generating Unit Name (e.g. Unit 1)** _____

DATA DESCRIPTION	UNITS	DATA CAT	GENERATING UNIT DATA			
			1	2	3	4
Alternative Fuel Type (*please specify)	Text	DPD	Oil distillate	Other gas*	Other*	Other*
CHANGEOVER TO ALTERNATIVE FUEL						
For off-line changeover:						
Time to carry out off-line fuel changeover	Minutes	DPD				
Maximum output following off-line changeover	MW	DPD				
For on-line changeover:						
Time to carry out on-line fuel changeover	Minutes	DPD				
Maximum output during on-line fuel changeover	MW	DPD				
Maximum output following on-line changeover	MW	DPD				
Maximum operating time at full load assuming:						
Typical stock levels	Hours	DPD				
Maximum possible stock levels	Hours	DPD				
Maximum rate of replacement of depleted stocks of alternative fuels on the basis of Good Industry Practice	MWh(electrical)/day	DPD				
Is changeover to alternative fuel used in normal operating arrangements?	Text	DPD				
Number of successful changeovers carried out in the last NGET Financial Year (* delete as appropriate)	Text	DPD	0 / 1-5 / 6-10 / 11-20 / >20 **	0 / 1-5 / 6-10 / 11-20 / >20 **	0 / 1-5 / 6-10 / 11-20 / >20 **	0 / 1-5 / 6-10 / 11-20 / >20 **

DATA DESCRIPTION	UNITS	DATA CAT	GENERATING UNIT DATA			
			1	2	3	4
CHANGEOVER BACK TO MAIN FUEL						
For off-line changeover: Time to carry out off-line fuel changeover	Minutes					
For on-line changeover: Time to carry out on-line fuel changeover	Minutes					
Maximum output during on-line fuel changeover	MW					

Notes

1. Where a **Generating Unit** has the facilities installed to generate using more than one alternative fuel type details of each alternative fuel should be given.
2. Significant factors and their effects which may prevent the use of alternative fuels achieving the estimated values provided in this table (e.g. emissions limits, distilled water stocks etc.) should be appended separately.

< End of **Data Registration Code (DRC)** >

GENERAL CONDITIONS

GC.1 INTRODUCTION

GC.1.1 The **General Conditions** contain provisions which are of general application to all provisions of the **Grid Code**. Their objective is to ensure, to the extent possible, that the various sections of the **Grid Code** work together and work in practice for the benefit of all **Users**.

GC.2 SCOPE

GC.2.1 The **General Conditions** apply to all **Users** (including, for the avoidance of doubt, **NGET**).

GC.3 UNFORESEEN CIRCUMSTANCES

GC.3.1 If circumstances arise which the provisions of the **Grid Code** have not foreseen, **NGET** shall, to the extent reasonably practicable in the circumstances, consult promptly and in good faith all affected **Users** in an effort to reach agreement as to what should be done. If agreement between **NGET** and those **Users** as to what should be done cannot be reached in the time available, **NGET** shall determine what is to be done. Wherever **NGET** makes a determination, it shall do so having regard, wherever possible, to the views expressed by **Users** and, in any event, to what is reasonable in all the circumstances. Each **User** shall comply with all instructions given to it by **NGET** following such a determination provided that the instructions are consistent with the then current technical parameters of the particular **User's System** registered under the **Grid Code**. **NGET** shall promptly refer all such unforeseen circumstances and any such determination to the Panel for consideration in accordance with GC.4.2(e).

GC.4 THE GRID CODE REVIEW PANEL

GC.4.1 **NGET** shall establish and maintain the **Panel**, which shall be a standing body to carry out the functions referred to in paragraph GC.4.2.

GC.4.2 The **Panel** shall:

- (a) keep the **Grid Code** and its working under review;
- (b) review all suggestions for amendments to the **Grid Code** which the **Authority** or any **User** or any **Relevant Transmission Licensee** (in respect of PC.6.2, PC Appendix A and C, CC.6.1, CC.6.2, CC.6.3, OC8 and GC.11, OC7.6, OC9.4 and OC9.5) may wish to submit to **NGET** for consideration by the **Panel** from time to time;
- (c) publish recommendations as to amendments to the **Grid Code** that **NGET** or the **Panel** feels are necessary or desirable and the reasons for the recommendations;
- (d) issue guidance in relation to the **Grid Code** and its implementation, performance and interpretation when asked to do so by any **User**;

- (e) consider what changes are necessary to the **Grid Code** arising out of any unforeseen circumstances referred to it by **NGET** under GC.3; and
- (f) consider and identify changes to the **Grid Code** to remove any unnecessary differences in the treatment of issues in Scotland from their treatment in England and Wales.

GC.4.3 The **Panel** shall consist of:

- (a) a Chairman and up to 4 members appointed by **NGET**;
- (b) a person appointed by the **Authority**; and
- (c) the following members:
 - (i) 3 persons representing those **Generators** each having **Large Power Stations** with a total **Registered Capacity** in excess of 3 GW;
 - (ii) a person representing those **Generators** each having **Large Power Stations** with a total **Registered Capacity** of 3 GW or less;
 - (iii) 2 persons representing the **Network Operators** in England and Wales;
 - (iv) a person representing the **Network Operators** in Scotland;
 - (v) a person representing the **Suppliers**;
 - (vi) a person representing the **Non Embedded Customers**;
 - (vii) a person representing the **Generators** with **Small Power Stations** and/or **Medium Power Stations** (other than **Generators** who also have **Large Power Stations**);
 - (viii) a person representing the **BSC Panel**;
 - (ix) a person representing the **Externally Interconnected System Operators**;
 - (x) a person representing **Generators** with **Novel Units**; and
 - (xi) a person representing each **Relevant Transmission Licensee** (in respect of PC.6.2, PC Appendix A and C, CC.6.1, CC.6.2, CC.6.3, OC8 and GC.11, OC7.6, OC9.4 and OC9.5).

each of whom shall be appointed pursuant to the rules issued pursuant to GC.4.4.

GC.4.4 The **Panel** shall establish and comply at all times with its own rules and procedures relating to the conduct of its business, which shall be approved by the **Authority**.

GC.4.5 **NGET** shall consult in writing all **Authorised Electricity Operators** which are liable to be materially affected in relation to all proposed amendments to the **Grid**

Code and shall submit all proposed amendments to the **Grid Code** to the **Panel** for discussion prior to such consultation.

GC.4.6 **NGET** shall establish (and, where appropriate, revise from time to time) joint working arrangements with the **STC Committee** to facilitate the identification, coordination, making and implementation of change to the **STC** consequent on an amendment to the **Grid Code** in a full and timely manner. These working arrangements shall be such as enable the consideration development and evaluation of proposed amendments to the **Grid Code** to proceed in a full and timely manner and enable changes to the **STC** consequent on an amendment to the **Grid Code** to be made and given effect wherever possible (subject to any necessary consent of the **Authority**) at the same time as such approved amendment is made and given effect.

GC.5 **COMMUNICATION BETWEEN NGET AND USERS**

GC.5.1 Unless otherwise specified in the **Grid Code**, all instructions given by **NGET** and communications (other than relating to the submission of data and notices) between **NGET** and **Users** (other than **Generators**, **DC Converter Station** owners or **Suppliers**) shall take place between the **NGET Control Engineer** based at the **Transmission Control Centre** notified by **NGET** to each **User** prior to connection, and the relevant **User Responsible Engineer/Operator**, who, in the case of a **Network Operator**, will be based at the **Control Centre** notified by the **Network Operator** to **NGET** prior to connection.

GC.5.2 Unless otherwise specified in the **Grid Code** all instructions given by **NGET** and communications (other than relating to the submission of data and notices) between **NGET** and **Generators** and/or **DC Converter Station** owners and/or **Suppliers** shall take place between the **NGET Control Engineer** based at the **Transmission Control Centre** notified by **NGET** to each **Generator** or **DC Converter Station** owner prior to connection, or to each **Supplier** prior to submission of **BM Unit Data**, and either the relevant **Generator's** or **DC Converter Station** owner's or **Supplier's Trading Point** (if it has established one) notified to **NGET** or the **Control Point** of the **Supplier** or the **Generator's Power Station** or **DC Converter Station**, as specified in each relevant section of the **Grid Code**. In the absence of notification to the contrary, the **Control Point** of a **Generator's Power Station** will be deemed to be the **Power Station** at which the **Generating Units** or **Power Park Modules** are situated.

GC.5.3 Unless otherwise specified in the **Grid Code**, all instructions given by **NGET** and communications (other than relating to the submission of data and notices) between **NGET** and **Users** will be given by means of the **Control Telephony** referred to in CC.6.5.2.

GC.5.4 If the **Transmission Control Centre** notified by **NGET** to each **User** prior to connection, or the **User Control Centre**, notified in the case of a **Network Operator** to **NGET** prior to connection, is moved to another location, whether due to an emergency or for any other reason, **NGET** shall notify the relevant **User** or the **User** shall notify **NGET**, as the case may be, of the new location and any changes to the **Control Telephony** necessitated by such move, as soon as practicable following the move.

- GC.5.5 If any **Trading Point** notified to **NGET** by a **Generator** or **DC Converter Station** owner prior to connection, or by a **Supplier** prior to submission of **BM Unit Data**, is moved to another location or is shut down, the **Generator, DC Converter Station** owner or **Supplier** shall immediately notify **NGET**.
- GC.5.6 The recording (by whatever means) of instructions or communications given by means of **Control Telephony** will be accepted by **NGET** and **Users** as evidence of those instructions or communications.
- GC.6 MISCELLANEOUS
- GC.6.1 Data and Notices
- GC.6.1.1 Data and notices to be submitted either to **NGET** or to **Users** under the **Grid Code** (other than data which is the subject of a specific requirement of the **Grid Code** as to the manner of its delivery) shall be delivered in writing either by hand or sent by first-class pre-paid post, or by facsimile transfer or by electronic mail to a specified address or addresses previously supplied by **NGET** or the **User** (as the case may be) for the purposes of submitting that data or those notices.
- GC.6.1.2 References in the **Grid Code** to “in writing” or “written” include typewriting, printing, lithography, and other modes of reproducing words in a legible and non-transitory form and in relation to submission of data and notices includes electronic communications.
- GC.6.1.3 Data delivered pursuant to paragraph GC.6.1.1, in the case of data being submitted to **NGET**, shall be addressed to the **Transmission Control Centre** at the address notified by **NGET** to each **User** prior to connection, or to such other Department within **NGET** or address, as **NGET** may notify each **User** from time to time, and in the case of notices to be submitted to **Users**, shall be addressed to the chief executive of the addressee (or such other person as may be notified by the **User** in writing to **NGET** from time to time) at its address(es) notified by each **User** to **NGET** in writing from time to time for the submission of data and service of notices under the **Grid Code** (or failing which to the registered or principal office of the addressee).
- GC.6.1.4 All data items, where applicable, will be referenced to nominal voltage and **Frequency** unless otherwise stated.
- GC.7 OWNERSHIP OF PLANT AND/OR APPARATUS
- References in the **Grid Code** to **Plant** and/or **Apparatus** of a **User** include **Plant** and/or **Apparatus** used by a **User** under any agreement with a third party.
- GC.8 SYSTEM CONTROL
- Where a **User's System** (or part thereof) is, by agreement, under the control of **NGET**, then for the purposes of communication and co-ordination in operational timescales **NGET** can (for those purposes only) treat that **User's System** (or part thereof) as part of the **GB Transmission System**, but, as between **NGET** and **Users**, it shall remain to be treated as the **User's System** (or part thereof).
- GC.9 EMERGENCY SITUATIONS

Users should note that the provisions of the **Grid Code** may be suspended, in whole or in part, during a Security Period, as more particularly provided in the **Fuel Security Code**, or pursuant to any directions given and/or orders made by the **Secretary of State** under section 96 of the **Act** or under the Energy Act 1976.

GC.10 MATTERS TO BE AGREED

Save where expressly stated in the **Grid Code** to the contrary where any matter is left to **NGET** and **Users** to agree and there is a failure so to agree the matter shall not without the consent of both **NGET** and **Users** be referred to arbitration pursuant to the rules of the **Electricity Supply Industry Arbitration Association**.

GC.11 GOVERNANCE OF ELECTRICAL STANDARDS

GC.11.1 In relation to the **Electrical Standards** the following provisions shall apply.

GC.11.2 (a) If a **User**, or in respect of (a) or (b) to the annex, **NGET**, or in respect of (c) or (d) to the annex, the **Relevant Transmission Licensee**, wishes to:-

- (i) raise a change to an **Electrical Standard**;
- (ii) add a new standard to the list of **Electrical Standards**;
- (iii) delete a standard from being an **Electrical Standard**,

it shall activate the **Electrical Standards** procedure.

(b) The **Electrical Standards** procedure is the notification to the secretary to the **Panel** of the wish to so change, add or delete an **Electrical Standard**. That notification must contain details of the proposal, including an explanation of why the proposal is being made.

GC.11.3 Ordinary **Electrical Standards** Procedure

- (a) Unless it is identified as an urgent **Electrical Standards** proposal (in which case GC.11.4 applies) or unless the notifier requests that it be tabled at the next **Panel** meeting, as soon as reasonably practicable following receipt of the notification, the **Panel** secretary shall forward the proposal, with a covering paper, to **Panel** members.
- (b) If no objections are raised within 20 Business Days of the date of the proposal, then it shall be deemed approved pursuant to the **Electrical Standards** procedure, and **NGET** shall make the change to the relevant **Electrical Standard** or the list of **Electrical Standards** contained in the Annex to this GC.11.
- (c) If there is an objection (or if the notifier had requested that it be tabled at the next **Panel** meeting rather than being dealt with in writing), then the proposal will be included in the agenda for the next following **Panel** meeting.

- (d) If there is broad consensus at the **Panel** meeting in favour of the proposal, **NGET** will make the change to the **Electrical Standard** or the list of **Electrical Standards** contained in the Annex to this GC.11.
- (e) If there is no such broad consensus, including where the Panel believes that further consultation is needed, **NGET** will establish a **Panel** working group if this was thought appropriate and in any event **NGET** shall undertake a consultation of **Authorised Electricity Operators** liable to be materially affected by the proposal.
- (f) Following such consultation, **NGET** will report back to **Panel** members, either in writing or at a **Panel** meeting. If there was broad consensus in the consultation, then **NGET** will make the change to the **Electrical Standard** or the list of **Electrical Standards** contained in the Annex to this GC.11.
- (g) Where following such consultation there is no broad consensus, the matter will be referred to the **Authority** who will decide whether the proposal should be implemented and will notify **NGET** of its decision. If the decision is to so implement the change, **NGET** will make the change to the **Electrical Standard** or the list of **Electrical Standards** contained in the Annex to this GC.11.
- (h) In all cases where a change is made to the list of **Electrical Standards**, **NGET** will publish and circulate a replacement page for the Annex to this GC covering that list and reflecting the change.

GC.11.4 Urgent **Electrical Standards** Procedure

- (a) If the notification is marked as an urgent **Electrical Standards** proposal, the **Panel** secretary will contact **Panel** members in writing to see whether a majority who are contactable agree that it is urgent and in that notification the secretary shall propose a timetable and procedure which shall be followed.
- (b) If such members do so agree, then the secretary will initiate the procedure accordingly, having first obtained the approval of the **Authority**.
- (c) If such members do not so agree, or if the **Authority** declines to approve the proposal being treated as an urgent one, the proposal will follow the ordinary **Electrical Standards** procedure as set out in GC.11.3 above.
- (d) If a proposal is implemented using the urgent **Electrical Standards** procedure, **NGET** will contact all **Panel** members after it is so implemented to check whether they wish to discuss further the implemented proposal to see whether an additional proposal should be considered to alter the implementation, such proposal following the ordinary **Electrical Standards** procedure.

GC.12 CONFIDENTIALITY

- GC.12.1 **Users** should note that although the **Grid Code** contains in certain sections specific provisions which relate to confidentiality, the confidentiality provisions set out in the **CUSC** apply generally to information and other data supplied as a requirement of or otherwise under the **Grid Code**.

GC.12.2 NGET has obligations under the **STC** to inform **Relevant Transmission Licensees** of certain data. **NGET** may pass on **User** data to a **Relevant Transmission Licensee** where **NGET** is required to do so under a provision of the **STC** current as at 1 April 2005. Those categories of **User** information that **NGET** is permitted to disclose to a **Relevant Transmission Licensee**, where required to do so by a provision of the **STC**, are set out in Schedule Three of the **STC** ('Information and data exchange specification').

GC.13 RELEVANT TRANSMISSION LICENSEES

GC.13.1 It is recognised that the **Relevant Transmission Licensees** are not parties to the **Grid Code**. Accordingly, notwithstanding that Operating Code No. 8 Appendix 2 ("OC8B"), OC7.6, OC9.4 and OC9.5 refer to obligations which will in practice be performed by the **Relevant Transmission Licensees** in accordance with relevant obligations under the **STC**, for the avoidance of doubt all contractual rights and obligations arising under OC8B, OC7.6, OC9.4 and OC9.5 shall exist between **NGET** and the relevant **User** and in relation to any enforcement of those rights and obligations OC8B, OC7.6, OC9.4 and OC9.5 shall be so read and construed. The **Relevant Transmission Licensees** shall enjoy no enforceable rights under OC8B, OC7.6, OC9.4 and OC9.5 nor shall they be liable (other than pursuant to the **STC**) for failing to discharge any obligations under OC8B, OC7.6, OC9.4 and OC9.5.

GC.13.2 For the avoidance of doubt nothing in this **Grid Code** confers on any **Relevant Transmission Licensee** any rights, powers or benefits for the purpose of the Contracts (Rights of Third Parties) Act 1999.

GC.14 BETTA TRANSITION ISSUES

GC.14.1 The provisions of the Appendix to the **General Conditions** apply in relation to issues arising out of the transition associated with the designation of amendments to the **Grid Code** by the **Secretary of State** in accordance with the provisions of the Energy Act 2004 for the purposes of Condition C14 of **NGET's Transmission Licence**.

GC.15 *Embedded Exemptable Large and Medium Power Stations*

GC.15.1 This GC.15.1 shall have an effect until and including 31st March 2007.

(i) CC.6.3.2, CC.6.3.7, CC.8.1 and BC3.5.1; and

(ii) Planning Code obligations and other Connection Conditions;

shall apply to a **User** who owns or operates

(a) an **Embedded Exemptable Large Power Station**, or

(b) an **Embedded Exemptable Medium Power Station** in Scotland

except where and to the extent that, in respect of that **Embedded Exemptable Large Power Station** or **Embedded Exemptable Medium Power Station**, **NGET** agrees or where the relevant **User** and **NGET** fail to agree, where and to the extent that the **Authority** consents.

Annex to the General Conditions

The **Electrical Standards** are as follows:-

(a)	NGTS 1	Ratings and General Requirements for Plant, Equipment, Apparatus and Services for the National Grid System and Direct Connections to it	Issue 5 Dec-03
	NGTS 2.1	Substations	Issue 4 Dec-03
	NGTS 3.1.1	Substation Interlocking Schemes	Issue 3 Dec-03
	NGTS 2.2	Switchgear for the National Grid System	Issue 4 Dec-03
	NGTS 3.2.1	Circuit-breakers and Switches	Issue 3 Dec-03
	NGTS 3.2.2	Disconnectors and Earthing Switches	Issue 4 Dec-03
	NGTS 3.2.3	Metal-Oxide Surge Arresters for use on 132, 275 & 400 kV Systems	Issue 4 Dec-03
	NGTS 3.2.4	Current Transformers for Protection and General Use on the 132 kV, 275 kV and 400 kV Systems	Issue 5 Dec-03
	NGTS 3.2.5	Voltage Transformers for use on the 132 kV, 275 kV and 400 kV Systems	Issue 4 Dec-03
	NGTS 3.2.6	Current and Voltage Measurement Transformers for Settlement Metering of the 33 * 66 kV, 132 kV, 275 kV and 400 kV Systems	Issue 2 Dec-03
	NGTS 3.2.7	Bushings for the National Grid System	Issue 3 Dec-03
	NGTS 3.2.9	Post Insulators for Substations	Issue 3 Dec-03
	NGTS 3.3.2	Dry-Type Reactors	Issue 3 Dec-03
	NGTS 3.3.3	Co-ordinating Gaps	Issue 1 Sep-92
	NGTS 2.6	Protection	Issue 3 Nov-98
	NGTS 3.6.3	Busbar Protection for 400 kV and 275 kV Double Busbar Switching Stations	Issue 3 Dec-96
	NGTS 3.6.8	Circuit-Breaker Fail Protection	Issue 3 Mar-99
	NGTS 3.11.1	Capacitors and Capacitor Banks	Issue 3 Dec-03

- (b) The following specifications for electronic data communications facilities with reference to EDT and EDL facilities.

EDT Interface Specification	Issue 4
EDT Submitter Guidance Note	Dec-01
EDL Message Interface Specifications	Issue 4
EDL Interface Specification Guidance Note	Oct-01
EDL Instruction Interface Valid Reason Codes	Issue 2

- (c) Scottish **Electrical Standards** for **SPT's Transmission System**.

SPTTS 1	Requirements for the SP Transmission System and Connection Points to it.	Issue 1
SPTTS 2.1	Substations	Issue 1
SPTTS 2.2	Switchgear	Issue 1
SPTTS 2.3	Transformers and Reactors	Issue 1
SPTTS 2.5	Cables	Issue 1
SPTTS 2.6	Protection	Issue 1
SPTTS 2.7	Substation Control Systems	Issue 1
SPTTS 2.12	Substation Auxiliary Supplies	Issue 1

- (d) Scottish **Electrical Standards** for **SHETL's Transmission System**.

1. NGTS 1: Rating and General Requirements for Plant, Equipment , Apparatus and Services for the National Grid System and Direct Connection to it.
Issue 3 March 1999.
2. NGTS 2.1: Substations
Issue 2 May 1995.
3. NGTS 3.1.1: Substation Interlocking Schemes.
Issue 1 October 1993.
4. NGTS 3.2.1: Circuit Breakers and Switches.

Issue 1 September 1992.
5. NGTS 3.2.2: Disconnectors and Earthing Switches.

Issue 1 March 1994.

6. NGTS 3.2.3: Metal-Oxide surge arresters for use on 132, 275 and 400kV systems.
Issue 2 May 1994.
7. NGTS 3.2.4: Current Transformers for protection and General use on the 132, 275 and 400kV systems.
Issue 1 September 1992.
8. NGTS 3.2.5: Voltage Transformers for use on the 132, 275 and 400 kV systems.
Issue 2 March 1994.
9. NGTS 3.2.6: Current and Voltage Measurement Transformers for Settlement Metering of 33, 66, 132, 275 and 400kV systems.
Issue 1 September 1992.
10. NGTS 3.2.7: Bushings for the Grid Systems.
Issue 1 September 1992.
11. NGTS 3.2.9: Post Insulators for Substations.
Issue 1 May 1996.
12. NGTS 2.6: Protection
Issue 2 June 1994.
13. NGTS 3.11.1: Capacitors and Capacitor Banks.
Issued 1 March 1993.

Appendix to the **General Conditions**

GC.A1 Introduction

GC.A1.1 This Appendix to the **General Conditions** deals with issues arising out of the transition associated with the designation of amendments to the **Grid Code** by the **Secretary of State** in accordance with the provisions of the Energy Act 2004 for the purposes of Condition C14 of **NGET's Transmission Licence**. For the purposes of this Appendix to the **General Conditions**, the version of the **Grid Code** as amended by the changes designated by the **Secretary of State** and as further amended from time to time shall be referred to as the "**GB Grid Code**".

GC.A1.2 The provisions of this Appendix to the **General Conditions** shall only apply to **Users** (as defined in GC.A1.4) and **NGET** after **Go-Live** for so long as is necessary for the transition requirements referred to in GC.A1.1 and cut-over requirements (as further detailed in GC.A3.1) to be undertaken.

GC.A1.3 In this Appendix to the **General Conditions**:

- (a) **Existing E&W Users** and **E&W Applicants** are referred to as "**E&W Users**";
- (b) **Users** who as at 1 January 2005 have entered into an agreement or have accepted an offer for connection to and/or use of the **Transmission System** of **NGET** are referred to as "**Existing E&W Users**";
- (c) **Users** (or prospective **Users**) other than **Existing E&W Users** who apply during the **Transition Period** for connection to and/or use of the **Transmission System** of **NGET** are referred to as "**E&W Applicants**";
- (d) **Existing Scottish Users** and **Scottish Applicants** are referred to as "**Scottish Users**";
- (e) **Users** who as at 1 January 2005 have entered into an agreement or have accepted an offer for connection to and/or use of the **Transmission System** of either **Relevant Transmission Licensee** are referred to as "**Existing Scottish Users**";
- (f) **Users** (or prospective **Users**) other than **Existing Scottish Users** who apply during the **Transition Period** for connection to and/or use of the **Transmission System** of either **Relevant Transmission Licensee** are referred to as "**Scottish Applicants**";
- (g) the term "**Transition Period**" means the period from **Go-Active** to **Go-Live** (unless it is provided to be different in relation to a particular provision), and is the period with which this Appendix to the **General Conditions** deals;
- (h) the term "**Interim GB SYS**" means the document of that name referred to in Condition C11 of **NGET's Transmission Licence**;
- (i) the term "**Go-Active**" means the date on which the amendments designated by the **Secretary of State** to the **Grid Code** in accordance with the Energy Act 2004 come into effect; and

- (j) the term “**Go-Live**” means the date which the **Secretary of State** indicates in a direction shall be the BETTA go-live date.

GC.A1.4 The provisions of GC.2.1 shall not apply in respect of this Appendix to the **General Conditions**, and in this Appendix to the **General Conditions** the term “**Users**” means:

- (a) **Generators**;
- (b) **Network Operators**;
- (c) **Non-Embedded Customers**;
- (d) **Suppliers**;
- (e) **BM Participants**; and
- (f) **Externally Interconnected System Operators**,
- (g) **DC Converter Station** owners

to the extent that the provisions of this Appendix to the **General Conditions** affect the rights and obligations of such **Users** under the other provisions of the **GB Grid Code**.

GC.A1.5 The **GB Grid Code** has been introduced with effect from **Go-Active** pursuant to the relevant licence changes introduced into **NGET’s Transmission Licence**. **NGET** is required to implement and comply, and **Users** to comply, with the **GB Grid Code** subject as provided in this Appendix to the **General Conditions**, which provides for the extent to which the **GB Grid Code** is to apply to **NGET** and **Users** during the **Transition Period**.

GC.A1.6 This Appendix to the **General Conditions** comprises:

- (a) this Introduction;
- (b) **GB Grid Code** transition issues; and
- (c) Cut-over issues.

GC.A1.7 Without prejudice to GC.A1.8, the failure of any **User** or **NGET** to comply with this Appendix to the **General Conditions** shall not invalidate or render ineffective any part of this Appendix to the **General Conditions** or actions undertaken pursuant to this Appendix to the **General Conditions**.

GC.A1.8 A **User** or **NGET** shall not be in breach of any part of this Appendix to the **General Conditions** to the extent that compliance with that part is beyond its power by reason of the fact that any other **User** or **NGET** is in default of its obligations under this Appendix to the **General Conditions**.

GC.A1.9 Without prejudice to any specific provision under this Appendix to the **General Conditions** as to the time within which or the manner in which a **User** or **NGET** should perform its obligations under this Appendix to the **General Conditions**, where a **User** or **NGET** is required to take any step or measure under this

Appendix to the **General Conditions**, such requirement shall be construed as including any obligation to:

- (a) take such step or measure as quickly as reasonably practicable; and
- (b) do such associated or ancillary things as may be necessary to complete such step or measure as quickly as reasonably practicable.

GC.A1.10 **NGET** shall use reasonable endeavours to identify any amendments it believes are needed to the **GB Grid Code** in respect of the matters referred to for the purposes of Condition C14 of **NGET's Transmission Licence** and in respect of the matters identified in GC.A1.11, and, having notified the **Authority** of its consultation plans in relation to such amendments, **NGET** shall consult in accordance with the instructions of the **Authority** concerning such proposed amendments.

GC.A1.11 The following matters potentially require amendments to the **GB Grid Code**:

- (a) The specific detail of the obligations needed to manage implementation in the period up to and following (for a temporary period) **Go-Live** to achieve the change to operation under the **GB Grid Code** (to be included in GC.A3).
- (b) Information (including data) and other requirements under the **GB Grid Code** applicable to **Scottish Users** during the **Transition Period** (to be included in GC.A2).
- (c) The conclusions of Ofgem/DTI in relation to small and/or embedded generator issues under BETTA and allocation of access rights on a GB basis.
- (d) Any arrangements required to make provision for operational liaison, including **Black Start** and islanding arrangements in Scotland.
- (e) Any arrangements required to make provision for cascade hydro **BM Units**.
- (f) Any consequential changes to the safety co-ordination arrangements resulting from **STC** and **STC** procedure development.
- (g) Any arrangements required to reflect the **Electrical Standards** for the **Transmission Systems** of **SPT** and **SHETL**.
- (h) The conclusions of Ofgem/DTI in relation to planning and operating standards.

GC.A1.12 **NGET** shall notify the **Authority** of any amendments that **NGET** identifies as needed pursuant to GC.A1.10 and shall make such amendments as the **Authority** approves.

GC.A2 **GB Grid Code Transition**

General Provisions

GC.A2.1 The provisions of the **GB Grid Code** shall be varied or suspended (and the requirements of the **GB Grid Code** shall be deemed to be satisfied) by or in accordance with, and for the period and to the extent set out in this GC.A2, and in accordance with the other applicable provisions in this Appendix to the **General Conditions**.

GC.A2.2 ***E&W Users:***

In furtherance of the licence provisions referred to in GC.A1.5, **E&W Users** shall comply with the **GB Grid Code** during the **Transition Period**, but shall comply with and be subject to it subject to this Appendix to the **General Conditions**, including on the basis that:

- (a) during the **Transition Period** the **Scottish Users** are only complying with the **GB Grid Code** in accordance with this Appendix to the **General Conditions**; and
- (b) during the **Transition Period** the **GB Transmission System** shall be limited to the **Transmission System** of **NGET**, and all rights and obligations of **E&W Users** in respect of the **GB Transmission System** under the **GB Grid Code** shall only apply in respect of the **Transmission System** of **NGET**, and all the provisions of the **GB Grid Code** shall be construed accordingly.

GC.A2.3 ***Scottish Users:***

In furtherance of the licence provisions referred to in GC.A1.5, **Scottish Users** shall comply with the **GB Grid Code** and the **GB Grid Code** shall apply to or in relation to them during the **Transition Period** only as provided in this Appendix to the **General Conditions**.

GC.A2.4 ***NGET:***

In furtherance of the licence provisions referred to in GC.A1.5, **NGET** shall implement and comply with the **GB Grid Code** during the **Transition Period**, but shall implement and comply with and be subject to it subject to, and taking into account, all the provisions of this Appendix to the **General Conditions**, including on the basis that:

- (a) during the **Transition Period** **NGET's** rights and obligations in relation to **E&W Users** in respect of the **GB Transmission System** under the **GB Grid Code** shall only apply in respect of the **Transmission System** of **NGET**, and all the provisions of the **GB Grid Code** shall be construed accordingly; and
- (b) during the **Transition Period** **NGET's** rights and obligations in relation to **Scottish Users** in respect of the **GB Transmission System** under the **GB Grid Code** shall only be as provided in this Appendix to the **General Conditions**.

Specific Provisions

GC.A2.5 ***Definitions:***

The provisions of the **GB Grid Code Glossary and Definitions** shall apply to and for the purposes of this Appendix to the **General Conditions** except where provided to the contrary in this Appendix to the **General Conditions**.

GC.A2.6 **Identification of Documents:**

In the period beginning at **Go-Active**, **Scottish Users** will work with **NGET** to identify and agree with **NGET** any documents needed to be in place in accordance with the **GB Grid Code**, to apply from **Go-Live** or as earlier provided for under this Appendix to the **General Conditions**, including (without limitation) **Site Responsibility Schedules**, **Gas Zone Diagrams** and **OC9 Desynchronised Island Procedures**.

GC.A2.7 **Data:**

Each **Scottish User** must provide, or enable a **Relevant Transmission Licensee** to provide, **NGET**, as soon as reasonably practicable upon request, with all data which **NGET** needs in order to implement, with effect from **Go-Live**, the **GB Grid Code** in relation to Scotland. This data will include, without limitation, the data that a new **User** is required to submit to **NGET** under CC.5.2. **NGET** is also entitled to receive data on **Scottish Users** over the **Relevant Transmission Licensees'** SCADA links to the extent that **NGET** needs it for use in testing and in order to implement, with effect from **Go-Live**, the **GB Grid Code** in relation to Scotland. After **Go-Live** such data shall, notwithstanding GC.A1.2, be treated as though it had been provided to **NGET** under the enduring provisions of the **GB Grid Code**.

GC.A2.8 **Verification of Data etc:**

NGET shall be entitled to request from a **Scottish User** (which shall comply as soon as reasonably practicable with such a request) confirmation and verification of any information (including data) that has been received by a **Relevant Transmission Licensee** under an existing grid code and passed on to **NGET** in respect of that **Scottish User**. After **Go-Live** such information (including data) shall, notwithstanding GC.A1.2, be treated as though provided to **NGET** under the enduring provisions of the **GB Grid Code**.

GC.A2.9 **Grid Code Review Panel:**

- (a) The individuals whose names are notified to **NGET** by the **Authority** prior to **Go-Active** as **Panel** members (and alternate members, if applicable) are agreed by **Users** (including **Scottish Users**) and **NGET** to constitute the **Panel** members and alternate members of the **Grid Code Review Panel** as at the first meeting of the **Grid Code Review Panel** after **Go-Active** as if they had been appointed as **Panel** members (and alternate members) pursuant to the relevant provisions of the Constitution and Rules of the **Grid Code Review Panel** incorporating amendments equivalent to the amendments to GC.4.2 and GC.4.3 designated by the **Secretary of State** in accordance with the provisions of the Energy Act 2004 for the purposes of Condition C14 of **NGET's Transmission Licence**.
- (b) The provisions of GC.4 of the **GB Grid Code** shall apply to, and in respect of, **Scottish Users** from **Go-Active**.

GC.A2.10 **Interim GB SYS:**

Where requirements are stated in, or in relation to, the **GB Grid Code** with reference to the **Seven Year Statement**, they shall be read and construed as necessary as being with reference to the **Interim GB SYS**.

GC.A2.11 **General Conditions:**

The provisions of GC.4, GC.12 and GC.13.2 of the **GB Grid Code** shall apply to and be complied with by **Scottish Users** in respect of this Appendix to the **General Conditions**.

GC.A2.12 **OC2 Data**

- (a) The following provisions of the **GB Grid Code** shall apply to and be complied with by **Scottish Users** with effect from the relevant date indicated below:
- (i) OC2.4.1.2.3 (a) from 19 January 2005 in respect of 2 to 52 week submissions,
 - (ii) OC2.4.1.2.4 (c) from 25 February 2005 in respect of 2 to 49 day submissions,
 - (iii) OC2.4.1.2.4 (b) from 22 March 2005 in respect of 2 to 14 day submissions,

The data to be submitted in respect of OC2.4.1.2.3 (a) and OC2.4.1.2.4 (b) and (c) need only be in respect of dates on or after 1 April 2005.

GC.A3 Cut-over

GC.A3.1 It is anticipated that it will be appropriate for arrangements to be put in place for final transition to BETTA in the period up to and following (for a temporary period) **Go-Live**, for the purposes of:

- (a) managing the transition from operations under the **Grid Code** as in force immediately prior to **Go-Active** to operations under the **GB Grid Code** and the **BSC** as in force on and after **Go-Active**;
- (b) managing the transition from operations under the existing grid code applicable to **Scottish Users** as in force immediately prior to **Go-Active** to operations under the **GB Grid Code** as in force on and after **Go-Active**;
- (c) managing the transition of certain data from operations under the existing grid code applicable to **Scottish Users** before and after **Go-Active**; and
- (d) managing **GB Grid Code** systems, processes and procedures so that they operate effectively at and from **Go-Live**.

GC.A3.2

- (a) The provisions of **BC1** (excluding BC1.5.1, BC1.5.2 and BC1.5.3) shall apply to and be complied with by **Scottish Users** and by **NGET** in respect |

of such **Scottish Users** with effect from 11:00 hours on the day prior to **Go-Live**

- (b) Notwithstanding (a) above, **Scottish Users** may submit data for **Go-Live** 3 days in advance of **Go-Live** on the basis set out in the **Data Validation, Consistency and Defaulting Rules** which shall apply to **Scottish Users** and **NGET** in respect of such **Scottish Users** on that basis and for such purpose.
- (c) The **Operational Day** for the purposes of any submissions by **Scottish Users** prior to **Go-Live** under a) and b) above for the day of **Go-Live** shall be 00:00 hours on **Go Live** to 05:00 hours on the following day.
- (d) The provisions of **BC2** shall apply to and be complied with by **Scottish Users** and by **NGET** in respect of such **Scottish Users** with effect from 23:00 hours on the day prior to **Go-Live**.
- (e) The provisions of **OC7.4.8** shall apply to and be complied with by **Scottish Users** and by **NGET** in respect of such **Scottish Users** with effect from 11:00 hours on the day prior to **Go-Live**.
- (f) In order to facilitate cut-over, **Scottish Users** acknowledge and agree that **NGET** will exchange data submitted by such **Scottish Users** under **BC1** prior to Go-Live with the Scottish system operators to the extent necessary to enable the cut-over.
- (g) Except in the case of **Reactive Power**, **Scottish Users** should only provide **Ancillary Services** from **Go-Live** where they have been instructed to do so by **NGET**. In the case of **Reactive Power**, at **Go-Live** a **Scottish Users** Mvar output will be deemed to be the level instructed by **NGET** under **BC2**, following this **Scottish Users** should operate in accordance with **BC2.A.2.6** on the basis that Mvar output will be allowed to vary with system conditions.

< End of GC >

REVISIONS

(This section does not form part of the Grid Code)

NGET's Transmission Licence sets out the way in which changes to the Grid Code are to be made and reference is also made to NGET's obligations under the General Conditions.

In order to ensure that Users have access to a current version of the Grid Code, Users who have purchased a serviced copy of the Grid Code receive a set of replacement pages containing the revisions made to the Grid Code pursuant to the Transmission Licence. Unserviced copies are not so updated but each unserviced copy issued is accompanied by all revisions since the date the unserviced version of the Grid Code was last reprinted.

All pages re-issued have the revision number and date of the revision on the lower right hand corner of the page. The changes to the text since the previous page issue are indicated by a vertical line to the right hand side of the text. Where repagination or repositioning of the text on other pages has been found necessary but the text itself has remained unchanged the re-issued pages have only the revision number and date of the revision included.

The Grid Code was introduced in March 1990 and this first issue was revised 31 times. In March 2001 the New Electricity Trading Arrangements were introduced and Issue 2 of the Grid Code was introduced which was revised 16 times. At British Electricity Trading and Transmission Arrangements (BETTA) Go-Active Issue 3 of the Grid Code was introduced.

The following 'index to revisions' provides a checklist to the pages and sections of the Grid Code changed by each revision to Issue 3 of the Grid Code.

All inquiries in relation to revisions to the Grid Code, including revisions to Issues 1 and 2, should be addressed to the Grid Code development team at the address given at the front of the Grid Code.

CODE	PAGE	CLAUSE
GD	20	Maximum Generation Service definition revised
OC7	12	OC7.4.8.5 (iii) amended to include MGS notification
BC2	12	BC2.9.2.4 amended to include reference to CUSC
BC2	13	BC2.9.3.2 (e) amended to include reference to CUSC and remove reference to MGS

CODE	PAGE	CLAUSE
GD	8	Version number and date of Data Validation, Consistency and Defaulting Rules updated to Issue 7, 11 th October 2004.
GD	23	Output Usable definition revised
OC1	5	Item (k) added to OC1.6.1
OC2	1	OC2.1.4 amended
OC2	4	OC2.4.1.2.1 (a) (ii) amended
OC2	5	OC2.4.1.2.1 (e) and (f) amended
OC2	7	OC2.4.1.2.2 (a) amended
OC2	8	OC2.4.1.2.2 (e) amended
OC2	9	OC2.4.1.2.3 (a) amended
OC2	20	Oc2.4.3.1 first paragraph amended
OC2 - Page 10 page break revised		

CODE	PAGE	CLAUSE
GD	5	Definitions of Cascade Hydro Scheme and Cascade Hydro Scheme Matrix added.
GD	7	Control Point definition updated for Cascade Hydro Schemes.
GD – Pages 4, 6 and 8 to 41 page breaks revised		
PC	3	PC3.2 (a) revised
PC	21	PC.A.3.1.3(a) revised
PC	23	PC.A.3.2.1(d) added. PC.A.3.2.2 revised
PC	24	PC.A.3.2.3(i) added.
PC – Pages 25 to 53 page breaks revised.		
CC	17	CC.6.5.6 (c) added
CC – Pages 18 to 25 page breaks revised		
OC2	1	OC2.1.3 Revised
OC2	3	OC2.4.1.2.1 Revised
OC2	4	OC2.4.1.2.1(b)(i) Revised
OC2	5	OC2.4.1.2.1(c)(ii) Revised
OC2	6	OC2.4.1.2.1(g)(ii) and (i) (2) Revised
OC2	7	OC2.4.1.2.2 and (i)(ii) Revised
OC2	8	OC2.4.1.2.2 (e), (g)(i) and (ii) Revised
OC2	9	OC2.4.1.2.3 and (a), (b), (c)(i) and (ii) Revised
OC2	10	OC2.4.1.2.3 (c)(ii) Revised, OC2.4.1.2.4 (b), (c),(d) (e)(i) revised
OC2	11	OC2.4.1.2.4 (e)(ii) Revised. OC2.4.1.3.1, OC2.4.1.3.2 (a), (b) Revised
OC2	12	OC2.4.1.3.2 (c), (e), OC2.4.1.3.3 (a), (b) Revised
OC2	13	OC2.4.1.3.3(c), (d), (e), (f) (g), (h)(i) Revised
OC2	14	OC2.4.1.3.3(h)(iii), (i) Revised
OC2	15	OC2.4.1.3.3(i)(z)(1) and (4) Revised and OC2.4.1.3.4 (a), (b) Revised

OC2	16	OC2.4.1.3.4(b) Revised
OC2	17	OC2.4.1.3.5(a) Revised
OC2	18	OC2.4.1.3.5(d) Revised. OC2.4.2.1(a) revised
OC2	20	OC2.4.2.1 (k) added
OC2 – Page 2 and Pages 21 to 24 Page breaks revised		
OC5	1	OC5.1 (y) and (z) added
OC5	3	OC5.5.1.1 Subsection (a) text revised and subsequent subsections renumbered
OC5 – Pages 2, 4 and 5 Page breaks revised		
BC1	3	BC1.4.2(a) (c) revised
BC1	4	BC1.4.2 (d), (e), (f) revised
BC1	5	BC1.4.2 (f)(vi) added. BC1.4.3 and BC1.4.5 revised
BC1	6	BC1.4.5 (b) and BC1.4.5 last paragraph revised.
BC1	12	Appendix 1, first paragraph revised
BC1	17	BC1.A.1.7 added
BC1 – Pages 7 to 11, 13 to 16 and 18 to 19 page breaks revised.		
BC2	2	BC2.5.1 and (b) revised
BC2	3	BC2.5.1(c), BC2.5.2.2 and (b), BC2.5.2.3 revised
BC2	4	BC2.5.2.4 revised
BC2	5	BC2.5.3.2, BC2.5.3.3 Revised
BC2	10	BC2.8 revised
BC2	13	BC2.9.3.2(f) added
BC2	19	BC2.A.1.3 revised
BC2 – Pages 6 to 9, 11 and 12, 14 to 18 and 20 page breaks revised.		
DRC	19	Schedule 3 – page 2 revised
DRC	31	Schedule 6 revised

Revision 4Effective Date: 19th January 2005

CODE	PAGE	CLAUSE
GC	15	New paragraph added – GC.A2.12

Revision 5Effective Date: 4th February 2005

CODE	PAGE	CLAUSE
GD	7	New Definition – Control Engineer
GD	16	New Definition – GB Transmission System Warning
GD	21	Definition of Local Joint Restoration Plan amended
GD	21	New Definition – Local Switching Procedure
GD	24	Definition of Operation Switching amended
GD	26	Definition of Power Island amended
GD – Pages 17 to 20, 22, 23, 25, 27 and 28 page breaks revised.		
PC	51	Appendix C – C1.1, C1.2 and C1.3 added. Part 1 amended
PC	53	Appendix C – Part 2 amended
CC	26	CC.A.1.1.1 and CC.A.1.1.4(b) amended
CC	27	Footnote 1 amended
CC	32	SPT SRS added
CC	33	Scottish Hydro-Electric SRS added
CC- Pages 28, 34 to 46 page breaks amended		
OC7	1	OC7.1.5 and OC7.1.6 added
OC7	2	OC7.2.4 and OC7.3.1 amended
OC7	16 to 19	OC7.6 and associated sections added
OC7 – Pages 3 15 , 20 page breaks amended		
OC8	2	OC8.4.1.1 and OC8.4.2.1 amended

OC8A	OC8A-1	OC8A.1.1, OC8A.1.3 amended
OC8A – Pages OC8A – 2 to OC8A – 12 page breaks amended		
OC8B	OC8B - 1	OC8B.1.1, OC8B.1.3 amended
OC8B – Pages OC8B – 2 to OC8B – 8 amended		
OC9	1	OC9.1.5 added
OC9	2	OC9.2.4 and OC9.3.3 added
OC9	3	OC9.4.5.3 added. OC9.4.6 amended
OC9	4	OC9.4.7.3, OC9.4.7.4(a) amended
OC9	5	OC9.4.7.6 (d) and (e) amended
OC9	6	OC9.4.7.6 (f) and (g) amended
OC9	7	OC9.4.7.11 (a) and (b) amended
OC9	8/9	OC9.4.7.11 (c) added
OC9	9	OC9.5 paragraph added. OC9.5.1 (b) amended
OC9	10	OC9.5.2, OC9.5.2.1(a) and (d), OC9.5.2.2(b) amended
OC9	11	OC9.5.2.3(a) amended
OC9	12	OC9.5.4.1 (b) and (c)(iii), (iv), amended. OC9.5.4.1(c)(v) and (vi) added
OC9	13	OC9.5.4.1 (h) amended
OC9 – Pages 14 to 16 page breaks amended		
GC	1	GC.4.2(b) amended
GC	2	GC.4.3(c)(xi) amended
GC	6/7	GC.13.1 amended
GC	9/10	Annex (c) and (d) added
GC	16	GC.A2.12 Amended
GC – Pages 11 to 15 page breaks amended		

CODE	PAGE	CLAUSE
GD	3	Definition of Bilateral Agreement amended
GD	4	Definition of BM Participant amended
GD	6	Definition of Construction Agreement amended
GD	7	Definition of Control Point amended
GD	12	Definition of Exemptable added
GD	17	Definition of Generating Unit Data added
GD	26	Definition of Physical Notifications amended
GD	41	Section 2.(vi) amended
GD – Pages 13 to 16, 18 to 42 page breaks changed.		
OC5	1	OC5.1 (y) amended
OC5	2	OC5.1 (1) and (2) amended
OC5 – Pages 1 to 5 page breaks changed.		
BC1	1	BC1.2 and BC1.4 amended
BC1	2	BC1.4.1(a), (d)(i) amended
BC1	3	BC1.4.2(a)(1) and (2) amended
BC1	4	BC1.4.2(c), (d), (e), (f) amended
BC1	5	BC1.4.3 amended
BC1	6	BC1.4.5 amended.
BC1	8	BC1.5.4(b) amended
BC1	9	BC1.5.5 amended
BC1	10	BC1.6.1(b)(i) amended
BC1	11	BC1.6.2 amended
BC1	12	First para Appendix 1 amended
BC1	16	CCGT Module Matrix example form amended
BC1	18	BC1.A.2.2 (ii) amended
BC1	19	BC1.A.2.3 Constraint Boundary (ii) amended.

BC1 – Pages 1 to 10, 18 page breaks changed.		
BC2	1	BC2.1(a), BC2.2 amended.
BC2	2	BC2.4.1(b) (b), BC2.5.1 amended.
BC2	3	BC2.5.1 (b) and other text amended, BC2.5.2.2, BC2.5.2.3 amended
BC2	4	BC2.5.2.4 amended
BC2	5	BC2.5.3.2, BC2.5.3.3 amended
BC2	6	BC2.5.5.1, BC2.5.5.2 amended
BC2	7	BC2.6.1(a)(b) amended
BC2	8	BC2.6.2, BC2.6.5(a) amended
BC2	11	BC2.8, BC2.8.1(b)(e) amended
BC2	12	BC2.8.4(a)(c)(d), BC2.9.1.2(c) amended
BC2	13	BC2.9.1.3, BC2.9.2.3, BC2.9.3.1, BC2.9.3.2(b) amended
BC2	15	BC2.9.4.4, BC2.9.4.5, BC2.9.4.6, BC2.9.5, BC2.9.5.1 amended
BC2	16	BC2.9.7.2(b) amended
BC2	17	BC2.9.7.2(b) amended
BC2	22	BC2.A.2.1 amended
BC2	27	BC2.A.3.1 amended
BC2	29	Annexure 2 amended
BC2 – Pages 1 to 29 page breaks changed.		

Revision 7

Effective Date: 16th March 2005

CODE	PAGE	CLAUSE
GC	16	New section added – GC.A3.2 (a)
GC	17	New section added – GC.A3.2 (b) to (g)

Revision 8Effective Date: 30th March 2005

CODE	PAGE	CLAUSE
PC	1	PC.1.1 amended
GC	1	GC.4.2 (b) amended
GC	2	GC.4.3 (c) (xi) amended
GC	6/7	GC.12.2 added

Revision 9Effective Date: 1st April 2005

CODE	PAGE	CLAUSE
CC	12	CC.6.3.1 amended

Revision 10Effective Date: 1st June 2005

CODE	PAGE	CLAUSE
Preface	1	Paragraph 1
G&D	2	Auxillaries
	7 to 10	Control Centre, Control Point, DC Converter added, Designed Minimum Operating Level, DC Converter Station added, DC Network added, De-Synchronise, Droop added
	17	Generating Unit, Genset, Grid Entry Point
	19 to 20	Import Usable added, Intermittent Power Source added
	22	Limited Frequency Sensitive Mode, Limited High Frequency Response
	24 to 26	Minimum Generation, Minimum Import Capacity added, Mothballed DC Converter at a DC Converter Station added, Mothballed Power Park Module added, Non-Synchronous Generating Unit added, Operational Intertripping

	28 to 29	Power Park Module added, Power Park Module Availability Matrix added, Power Park Module Planning Matrix added, Power Park Unit added, Power Station
	31 to 32	Rated MW, Registered Capacity, Registered Import Capability added
	35 to 38	Slope added, Station Transformer, Synchronised, Synchronous Generating Unit added, System Constrained Capacity.
	42	User System Entry Point
G&D – Page breaks on all pages from Page 1		
PC	All Pages	Substantial amendments to most sections associated with Generic Provisions
CC	All Pages	Substantial amendments to most sections associated with Generic Provisions
OC2	1	OC2.1.1, OC2.1.2
	3	OC2.3.1(d)
	10	OC2.4.1.2.4(b)
	19	OC2.4.2.1(f)(g)
	20	OC2.4.2.1(h)(j)(l)
	24	OC2.4..4.3
	27	Figure added
	31	Appendix 4 added
OC5	1	OC5.1 (b)
	2	OC5.2(d), OC5.3(e)
	3	OC5.4.2.2
	4	OC5.5.1.2
	5	OC5.5.2.2
	8, 9, 10	OC5.5.3
	12	OC5.6.2

OC5 – Pages 2 to 15 Page Breaks amended		
OC7	2	OC7.3.1(f)
	5	OC7.4.5.9(a)(b)
	8	OC7.4.6.10(a)(b)
	9	OC7.4.6.12
	14	OC7.5.2(a)(iv)
	15	OC7.5.8(b)
	20	OC7 Appendix
OC7 – Pages 1 to 20 Page Breaks amended		
OC10	1	OC10.3.1(d)
	2	OC10.4.1.2(a)(b)
	3	OC10.4.2.3(iii)(iv)
	4	Paragraph 6 and 7
OC10 – Pages 2 to 4 Page Breaks amended		
OC11	1	OC11.3.1(d)
OC12	1	OC12.3(d)
BC1	3	BC1.4.2(a)(1)(ii), (2)
	5	BC1.4.2(f)(vii)
	10	BC1.6.1(a)(i),(b)(i)
	11	BC1.6.2
	12	Appendix 1 first paragraph
	17/18	BC1.A.1.8
	19	BC1A.2.2(ii)
	20	BC1.A.2.3 Constraint Boundary Information(ii)
BC1 – Pages 4 to 11, 17 to 20 Page Breaks amended		
BC2	5	BC2.5.4(b)(c)
	6	BC2.5.4(c)(ii),(d), (h), BC2.5.5.1

	7	BC2.5.5.2
	11	BC2.7.5(d)
	13	BC2.9.12(c)
	14	BC2.9.3.2(c)(g)
	18	BC2.11.2(a)(b)(c)
	19	BC2.11.2(d), BC2.11.3
	27	BC2.A.3.1 Definitions of Full Output and Minimum Output
	29	Annexure 2
BC2 – Pages 5 to 20, 27 to 29 Page Breaks amended		
BC3	All Pages	Substantial amendments to most sections associated with Generic Provisions
DRC	1 and 2	DRC.3.1
	4	DRC.6.1.1, DRC.6.1.4
	5	DRC.6.1.13, DRC.6.1.15
	6	DRC.6.2
	7 to 21	Schedule 1 Pages 9 to 15 added
	22 to 24	Schedule 2 Pages 1 and 3
	25	Schedule 3 Page 1
	28	Schedule 4 Page 1
	34	Schedule 5 Page 6
	53	Schedule Page 1
DRC – Pages 2 to 55 Page Breaks amended		
GC	3	GC.5.1, GC.5.2
	4	GC.5.5
	12	GC.A.1.4(g)
GC – Pages 3 to 7, 12 to 17 Page Breaks amended		

CODE	PAGE	CLAUSE
G&D	5	Definitions of Category 1, 2, 3 and 4 Intertripping Scheme added
	11	Definition of Earthing amended
	19	Definition of Group added
	22	Definition of Isolation amended
	35	Definitions of Secured Event and Security and Quality of Supply Standard added
	40	Definitions of System to Generator Operational Intertripping and System to Generator Intertripping Scheme added
G&D – Pages 5 to 46 page breaks amended		
CC	12	CC.6.2.3.2(b) added
	15	CC.6.3.3(b) amended
	23	CC.6.3.17 added
	34	CC.8.1(e) added
CC – Pages 15 to 33 page breaks amended		
OC2	12	OC2.4.1.3.2(e) amended
	14	OC2.4.1.3.3(h) (ii) amended
	17	OC2.4.1.3.4 (d) after (iii) amended OC2.4.1.3.5 (a) (ii) amended
OC2 – Pages 12 to 17 page breaks amended		
OC8A	2	OC8A.1.6.2 (2) and (3) amended
	6	OC8A.5.2.2 (c) (i) amended
	7	OC8A.5.2.3 amended OC8A.5.3.2 (b) (i) amended
	8	OC8A.5.4.2 amended
	9	OC8A.5.5.5 amended
	13	OC8A.8.4.2 formatting amended
OC8A – Paged 2 to 21 page breaks amended		

OC8B	2	OC8B.1.7.2 (2) and (3) amended
	7	OC8B.5.2.2 (c) (i) amended OC8B.5.2.3 amended
	8	OC8B.5.3.2 (b) (i) amended OC8B.5.4.2 amended
	9	OC8B.5.5.5 amended
	13	OC8B.8.4.2 formatting amended
OC8B – Pages 2 to 11 page breaks amended		
BC1	11	BC1.7.1 (a) amended
BC2		
BC2	4	BC2.5.2.3(b) amended
	5	BC2.5.3.1 amended
	11	BC2.8.1 (f) added
	14	BC2.9.3.2 (a) amended
	17	BC2.10.2 (a) added
	18	BC2.10.3 amended
	22	BC2.A.2.1 (e) added
BC2 – Pages 2 to 19, 22 to 25 page breaks amended		

Revision 12

Effective Date: 30 September 2005

CODE	PAGE	CLAUSE
All Codes		All references in all codes to NGC replaced with NGET
G&D		
G&D	26	Definition of NGC deleted. Definition of NGET added.
	28	Definition of Output Usable revised
OC2		
OC2	2	OC2.1.7 deleted and OC2.1.8 renumbered as OC2.1.7
BC2		
BC2	8	BC2.6.1 (h) added

BC2	31	Appendix 4 added
	32	Annexure 1 added
General Conditions	7	GC.15.1 cut-off date amended to 31 March 2007. Typographical error corrected in GC.15.1(a)